

DATA SHEET

SURFACE MOUNT MULTILAYER CERAMIC CAPACITORS

General purpose & High capacitance

Class 2, X5R

4 V TO 50 V

100 pF to 220 μ F

RoHS compliant & Halogen free



SCOPE

This specification describes X5R series chip capacitors with lead-free terminations.

APPLICATIONS

- PCs, Hard disk, Game PCs
- Power supplies
- DVD players
- Mobile phones
- Data processing

FEATURES

- Supplied in tape on reel
- Nickel-barrier end termination
- RoHS compliant
- Halogen free compliant

ORDERING INFORMATION - GLOBAL PART NUMBER, PHYCOMP

CTC & I2NC

All part numbers are identified by the series, size, tolerance, TC material, packing style, voltage, process code, termination and capacitance value.

YAGEO BRAND ordering code

GLOBAL PART NUMBER (PREFERRED)

CC XXXX X X **X5R** X **BB** XXX
 (1) (2) (3) (4) (5)

(1) SIZE – INCH BASED (METRIC)

- 0201 (0603)
- 0402 (1005)
- 0603 (1608)
- 0805 (2012)
- 1206 (3216)
- 1210 (3225)

(2) TOLERANCE

- K = ±10%
- M = ±20%

(3) PACKING STYLE

- R = Paper/PE taping reel; Reel 7 inch
- K = Blister taping reel; Reel 7 inch
- P = Paper/PE taping reel; Reel 13 inch
- F = Blister taping reel; Reel 13 inch
- C = Bulk case

(4) RATED VOLTAGE

- 4 = 4 V
- 5 = 6.3 V
- 6 = 10 V
- 7 = 16 V
- 8 = 25 V
- 9 = 50 V

(5) CAPACITANCE VALUE

2 significant digits+number of zeros
 The 3rd digit signifies the multiplying factor, and letter R is decimal point
 Example: 103 = 10 × 10³ = 10,000 pF = 10 nF

CONSTRUCTION

The capacitor consists of a rectangular block of ceramic dielectric in which a number of interleaved metal electrodes are contained. This structure gives rise to a high capacitance per unit volume.

The inner electrodes are connected to the two end terminations and finally covered with a layer of plated tin (NiSn). The terminations are lead-free. A cross section of the structure is shown in Fig. 1.

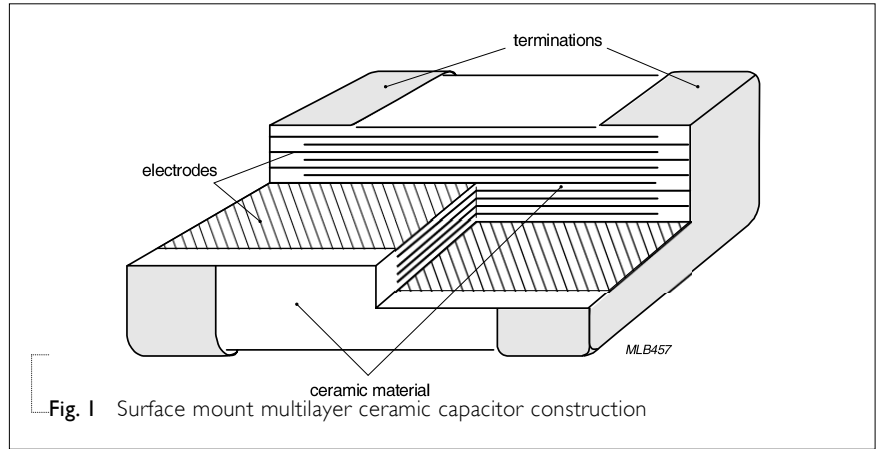

Fig. 1 Surface mount multilayer ceramic capacitor construction

DIMENSION

Table I For outlines see fig. 2

| TYPE | L ₁ (mm) | W (mm) | T (MM) | L ₂ / L ₃ (mm) | | L ₄ (mm) | DIMENSION CODE |
|------|---------------------|------------|------------|--------------------------------------|------|---------------------|----------------|
| | | | | min. | max. | | |
| 0201 | 0.6 ±0.03 | 0.3 ±0.03 | 0.3 ±0.03 | 0.1 | 0.2 | 0.2 | BA |
| | 0.6 ±0.05 | 0.3 ±0.05 | 0.3 ±0.05 | 0.1 | 0.2 | 0.2 | BB |
| | 0.6 ±0.09 | 0.3 ±0.09 | 0.3 ±0.09 | 0.1 | 0.25 | 0.2 | BC |
| | 0.6 ±0.15 | 0.3 ±0.15 | 0.3 ±0.15 | 0.1 | 0.25 | 0.2 | BD |
| 0402 | 1.0 ±0.05 | 0.5 ±0.05 | 0.5 ±0.05 | 0.15 | 0.35 | 0.4 | CA |
| | 1.0 ±0.10 | 0.5 ±0.10 | 0.5 ±0.10 | 0.15 | 0.35 | 0.4 | CB |
| | 1.0 ±0.15 | 0.5 ±0.15 | 0.5 ±0.15 | 0.15 | 0.35 | 0.4 | CC |
| | 1.0 ±0.20 | 0.5 ±0.20 | 0.5 ±0.20 | 0.15 | 0.35 | 0.4 | CD |
| 0603 | 1.6 ±0.10 | 0.8 ±0.10 | 0.8 ±0.10 | 0.2 | 0.6 | 0.4 | DA |
| | 1.6 ±0.15 | 0.8 ±0.15 | 0.8 ±0.15 | 0.2 | 0.6 | 0.4 | DB |
| | 1.6 ±0.20 | 0.8 ±0.20 | 0.8 ±0.20 | 0.2 | 0.6 | 0.4 | DC |
| 0805 | 2.0 ±0.20 | 1.25 ±0.20 | 0.85 ±0.10 | 0.25 | 0.75 | 0.7 | EA |
| | 2.0 ±0.20 | 1.25 ±0.20 | 1.25 ±0.20 | 0.25 | 0.75 | 0.7 | EB |
| 1206 | 3.2 ±0.15 | 1.6 ±0.15 | 1.15 ±0.10 | 0.25 | 0.75 | 1.4 | FA |
| | 3.2 ±0.30 | 1.6 ±0.20 | 1.25 ±0.20 | 0.25 | 0.75 | 1.4 | FB |
| | 3.2 ±0.30 | 1.6 ±0.30 | 1.60 ±0.20 | 0.25 | 0.80 | 1.4 | FC |
| | 3.2 ±0.30 | 1.6 ±0.30 | 1.60 ±0.30 | 0.30 | 0.90 | 1.4 | FD |
| 1210 | 3.2 ±0.40 | 2.5 ±0.30 | 1.25 ±0.20 | 0.25 | 0.75 | 1.4 | GA |
| | 3.2 ±0.40 | 2.5 ±0.30 | 1.90 ±0.20 | 0.25 | 0.75 | 1.4 | GB |
| | 3.2 ±0.40 | 2.5 ±0.30 | 2.5 ±0.20 | 0.25 | 0.75 | 1.0 | GC |
| | 3.2 ±0.40 | 2.5 ±0.30 | 2.5 ±0.30 | 0.25 | 0.75 | 1.0 | GD |

OUTLINES



Fig. 2 Surface mount multilayer ceramic capacitor dimension

CAPACITANCE RANGE & THICKNESS FOR X5R

Table 2 Sizes from 0201 to 0402

| CAP. | 0201 | | | | | 0402 | | | | | | |
|--------|------|-------|------|------|------|------|-----|-------|------|------|------|------|
| | 4 V | 6.3 V | 10 V | 16 V | 25 V | 50 V | 4 V | 6.3 V | 10 V | 16 V | 25 V | 50 V |
| 100 pF | | BA | BA | BA | BA | BA | | | | | | |
| 150 pF | | BA | BA | BA | BA | BA | | | | | | |
| 220 pF | | BA | BA | BA | BA | BA | | | | | | |
| 330 pF | | BA | BA | BA | BA | BA | | | | | | |
| 470 pF | | BA | BA | BA | BA | BA | | | | | | |
| 680 pF | | BA | BA | BA | BA | BA | | | | | | |
| 1.0 nF | | BA | BA | BA | BA | BA | | | | | | |
| 1.5 nF | | BA | BA | BA | BA | | | | | | | |
| 2.2 nF | | BA | BA | BA | BA | | | | | | | |
| 3.3 nF | | BA | BA | BA | BA | | | | | | | |
| 4.7 nF | | BA | BA | BA | BA | | | | | | | |
| 6.8 nF | | BA | BA | BA | BA | | | | | | | |
| 10 nF | | BA | BA | BA | BA | | | | | | | |
| 15 nF | | BA | BA | BA | | | | | | | | |
| 22 nF | | BA | BA | BA | BA | | | CA | CA | CA | CA | CA |
| 33 nF | | BA | BA | BA | | | | CA | CA | CA | CA | CA |
| 47 nF | | BA | BA | BA | | | | CA | CA | CA | CA | CA |
| 68 nF | | BA | BA | BA | | | | CA | CA | CA | CA | CA |
| 100 nF | | BA | BA | BA | BB | | | CA | CA | CA | CA | CA |
| 150 nF | | | | | | | | CA | CA | CA | CA | CA |
| 220 nF | BA | BA | BA | BA | | | | CA | CA | CA | CA | CA |
| 330 nF | | | | | | | | CA | CA | | | |
| 470 nF | BA | BA | BA | BA | | | | CA | CA | CB | CB | CB |
| 680 nF | | | | | | | | CA | CA | | | |
| 1.0 µF | BB | BB | BB | | | | | CA | CA | CA | CA | |
| 2.2 µF | BC | BC | BC | | | | | CA | CA | CC | CD | |
| 4.7 µF | BD | | | | | | CC | CC | CC | CC | | |
| 10 µF | | | | | | | CD | CD | CD | | | |
| 22 µF | | | | | | | CD | CD | | | | |

NOTE

1. Values in shaded cells indicate thickness class in mm
2. Capacitance value of non E-6 series is available on request

CAPACITANCE RANGE & THICKNESS FOR X5R

Table 3 Sizes from 0603 to 0805

| CAP. | 0603 | | | | | | 0805 | | | | | |
|--------|------|-------|------|------|------|-----|------|----------|----------|----------|----------|-----|
| | 4V | 6.3 V | 10 V | 16 V | 25 V | 50V | 4V | 6.3 V | 10 V | 16 V | 25 V | 50V |
| 10 nF | | | | | | | | | | | | |
| 15 nF | | | | | | | | | | | | |
| 22 nF | | | | | | | | | | | | |
| 33 nF | | | | | | | | | | | | |
| 47nF | | | | | | | | | | | | |
| 68 nF | | | | | | | | | | | | |
| 100 nF | | | | | | | | | | | | |
| 150 nF | | | | | | | | | | | | |
| 220 nF | | DA | DA | DA | DA | DA | | | | | | |
| 330 nF | | DA | DA | DA | DA | DA | | | | | | |
| 470 nF | | DA | DA | DA | DA | DA | | EA EB | EA EB | EA EB | EB | EB |
| 680 nF | | DA | DA | DA | DA | DA | | EA EB | EA EB | EA EB | EB | EB |
| 1.0 µF | | DA | DA | DA | DA | DA | | EA EB | EA EB | EA EB | EB | EB |
| 2.2 µF | | DA | DA | DA | DB | DC | | EA EB | EA EB | EA EB | EA EB | EB |
| 4.7 µF | | DA | DA | DB | DB | | | EA EB | EA EB | EB | EB | EB |
| 10 µF | | DB | DC | DC | DC | | | EA EB | EA EB | EB | EB | EB |
| 22 µF | | DC | DC | | | | | EB | EB | EB | EB | |
| 47 µF | DC | DC | | | | | | EB | EB | | | |
| 100 µF | | | | | | | EB | EB | | | | |

NOTE

1. Values in shaded cells indicate thickness class in mm
2. Capacitance value of non E-6 series is available on request

Table 4 Sizes from 1206 to 1210

| CAP. | 1206 | | | | | | 1210 | | | | |
|-------------|------|-------|------|------|------|-----|-------|------|------|------|-----|
| | 4 V | 6.3 V | 10 V | 16 V | 25 V | 50V | 6.3 V | 10 V | 16 V | 25 V | 50V |
| 10 nF | | | | | | | | | | | |
| 15 nF | | | | | | | | | | | |
| 22 nF | | | | | | | | | | | |
| 33 nF | | | | | | | | | | | |
| 47nF | | | | | | | | | | | |
| 68 nF | | | | | | | | | | | |
| 100 nF | | | | | | | | | | | |
| 150 nF | | | | | | | | | | | |
| 220 nF | | | | | | | | | | | |
| 330 nF | | | | | | | | | | | |
| 470 nF | | | | | | | | | | | |
| 680 nF | | | | | | | | | | | |
| 1.0 μ F | | FA | FA | FA | FA | FC | GA | GA | GA | GA | GA |
| 2.2 μ F | | FA | FA | FA | FA | FC | GB | GB | GB | GB | GB |
| 4.7 μ F | | FC | FC | FC | FC | FC | GB | GB | GB | GB | GC |
| 10 μ F | | FC | FC | FC | FC | FD | GB | GB | GB | GB | GC |
| 22 μ F | | FC | FC | FC | FD | | GC | GC | GC | GD | |
| 47 μ F | | FC | FC | FD | | | GC | GC | GC | | |
| 100 μ F | | FD | | | | | GD | GD | GD | | |
| 220 μ F | FD | | | | | | GD | | | | |

NOTE

1. Values in shaded cells indicate thickness class in mm
2. Capacitance value of non E-6 series is available on request

THICKNESS CLASSES AND PACKING QUANTITY

Table 5

| SIZE CODE | THICKNESS CLASSIFICATION | TAPE WIDTH QUANTITY PER REEL | Ø180 MM / 7 INCH | | Ø330 MM / 13 INCH | | QUANTITY PER BULK CASE |
|-------------|--------------------------|---------------------------------|------------------|---------|-------------------|---------|------------------------|
| | | | Paper | Blister | Paper | Blister | |
| 0201 | 0.3 ±0.03 mm | 8 mm | 15,000 | --- | 50,000 | --- | --- |
| 0402 | 0.5 ±0.05 / 0.1 mm | 8 mm | 10,000 | --- | 50,000 | --- | 50,000 |
| | 0.5 ±0.15 / 0.2 mm | 8 mm | 10,000 | --- | 40,000 | --- | --- |
| 0603 | 0.8 ±0.1 mm | 8 mm | 4,000 | --- | 15,000 | --- | 15,000 |
| 0805 | 0.6 ±0.1 mm | 8 mm | 4,000 | --- | 20,000 | --- | 10,000 |
| | 0.85 ±0.1 mm | 8 mm | 4,000 | --- | 15,000 | --- | 8,000 |
| | 1.25 ±0.2 mm | 8 mm | --- | 3,000 | --- | 10,000 | 5,000 |
| 1206 | 0.6 ±0.1 mm | 8 mm | 4,000 | --- | 20,000 | --- | --- |
| | 0.85 ±0.1 mm | 8 mm | 4,000 | --- | 15,000 | --- | --- |
| | 1.00 / 1.15 ±0.1 mm | 8 mm | --- | 3,000 | --- | 10,000 | --- |
| | 1.25 ±0.2 mm | 8 mm | --- | 3,000 | --- | 10,000 | --- |
| | 1.6 ±0.15 mm | 8 mm | --- | 2,500 | --- | 10,000 | --- |
| 1210 | 1.6 ±0.2 mm | 8 mm | --- | 2,000 | --- | 8,000 | --- |
| | 0.6 / 0.7 ±0.1 mm | 8 mm | --- | 4,000 | --- | 15,000 | --- |
| | 0.85 ±0.1 mm | 8 mm | --- | 4,000 | --- | 10,000 | --- |
| | 1.15 ±0.1 mm | 8 mm | --- | 3,000 | --- | 10,000 | --- |
| | 1.15 ±0.15 mm | 8 mm | --- | 3,000 | --- | 10,000 | --- |
| | 1.25 ±0.2 mm | 8 mm | --- | 3,000 | --- | --- | --- |
| | 1.5 ±0.1 mm | 8 mm | --- | 2,000 | --- | --- | --- |
| | 1.6 / 1.9 ±0.2 mm | 8 mm | --- | 2,000 | --- | --- | --- |
| 2.0 ±0.2 mm | 8 mm | --- | 2,000 | --- | --- | --- | |
| | 8 mm | --- | 1,000 | --- | --- | --- | |
| 2.5 ±0.2 mm | 8 mm | --- | 1,000 | --- | --- | --- | |
| | | | | 500 | | | |

ELECTRICAL CHARACTERISTICS

X5R DIELECTRIC CAPACITORS; NISN TERMINATIONS

Unless otherwise specified, all tests and measurements shall be made under standard atmospheric conditions for testing as given in 5.3 of IEC 60068-1:

- Temperature: 15 °C to 35 °C
- Relative humidity: 25% to 75%
- Air pressure: 86 kPa to 106 kPa

Before the measurements are made, the capacitor shall be stored at the measuring temperature for a time sufficient to allow the entire capacitor to reach this temperature.

The period as prescribed for recovery at the end of a test is normally sufficient for this purpose.

Table 6

| DESCRIPTION | VALUE | | | | | | |
|---|---|----------------|----------------|----------------|--------------|---------------|--------|
| Capacitance range | 100 pF to 220 μF | | | | | | |
| Capacitance tolerance | ±10% and ±20% | | | | | | |
| Dissipation factor (D.F.) | | | | | | | |
| X5R | 0201 | 0402 | 0603 | 0805 | 1206 | 1210 | D.F. |
| ≤ 6.3V | 100pF to 10nF | 22nF to 100nF | 220nF to 1uF | 470nF to 680nF | 1uF to 10uF | 1uF to 10uF | ≤ 5% |
| | | 120nF to 220nF | | | | 22uF | ≤ 7% |
| | 12nF to 1uF | 330nF to 10uF | 2.2uF to 47uF | 1uF to 100uF | 22uF to 47uF | 47uF to 220uF | ≤ 10% |
| | 2.2uF | | | | 100uF, 220uF | | ≤ 15% |
| | 4.7uF | 22uF | | | | | ≤ 20% |
| 10V | 100pF to 10nF | 22nF to 100nF | 220nF to 470nF | 470nF to 680nF | 1uF to 4.7uF | 1uF to 4.7uF | ≤ 5% |
| | | 120nF to 220nF | 680nF | 1uF | | | ≤ 7% |
| | 12nF to 220nF, 1uF | 330nF to 10uF | 1uF to 22uF | 2.2uF to 47uF | 10uF to 47uF | 10uF to 100uF | ≤ 10% |
| | 470nF | | | | | | ≤ 15% |
| | 2.2uF | | | | | | ≤ 20% |
| 16V | 100pF to 10nF | 22nF to 100nF | 220nF to 470nF | 470nF to 680nF | 1uF to 4.7uF | 1uF to 4.7uF | ≤ 5% |
| | | 120nF to 220nF | 680nF to 1uF | 1 uF to 2.2μF | | | ≤ 7% |
| | 12nF to 220nF | 470nF to 4.7uF | 2.2uF to 10uF | 4.7uF to 22uF | 10uF to 47uF | 10uF to 100uF | ≤ 10% |
| | 470nF | | | | | | ≤ 20% |
| | | | | | | | |
| 25V | 100pF to 10nF | 22nF | | 470nF to 1uF | 1uF to 2.2uF | 1uF to 4.7uF | ≤ 3.5% |
| | | 27nF to 100nF | 220nF to 470nF | 2.2uF | 4.7uF | 10uF | ≤ 5% |
| | | 120nF to 220nF | 680nF to 1uF | | | | ≤ 7% |
| | 22nF, 100nF | 470nF to 2.2uF | 2.2uF to 10uF | 4.7uF to 22uF | 10uF to 22uF | 22uF | ≤ 10% |
| | | | | | | | |
| 50V | 100pF to 1nF | 22nF | | | | | ≤ 3.5% |
| | | 27nF to 120nF | | | | | ≤ 5% |
| | | 150nF to 220nF | | | | | ≤ 7% |
| | | 470nF | 220nF to 2.2uF | 470nF to 10uF | 1uF to 10uF | 1uF to 10uF | ≤ 10% |
| | | | | | | | |
| Insulation resistance after 1 minute at Ur (DC) | Rins ≥ 10 GΩ or Rins × Cr ≥ 50/100/500* seconds whichever is less | | | | | | |
| Maximum capacitance change as a function of temperature (temperature characteristic/coefficient): | ±15% | | | | | | |
| Operating temperature range: | -55 °C to +85 °C | | | | | | |

NOTE

* Rins \geq 10 G Ω or Rins \times Cr \geq 500 Ω .F:
 0201 : 100pF to 47nF
 0402 : 22nF to 470nF
 0603 : 220nF to 1 μ F
 0805 : 470nF to 2.2 μ F, 4.7 μ F/6.3V to 16V
 1206 : 1 μ F to 2.2 μ F, 4.7 μ F/6.3V to 16V
 1210 : 1 μ F to 2.2 μ F, 4.7 μ F/6.3V to 16V

* Rins \times Cr \geq 100 Ω .F:
 0201 : 100nF to 470nF
 0402 : 1 μ F to 4.7 μ F
 0603 : 2.2 μ F to 4.7 μ F
 0805 : 4.7 μ F/16V to 50V, 10 μ F to 22 μ F/4V to 25V
 1206 : 4.7 μ F/25V to 50V, 10 μ F to 47 μ F
 1210 : 47 μ F to 220 μ F

* Rins \times Cr \geq 50 Ω .F:
 0201 : 1 μ F
 0402 : 10 μ F
 0603 : 10 μ F to 22 μ F
 0805 : 10 μ F/50V, 47 μ F to 100 μ F
 1206 : 100 μ F, 220 μ F

* Rins \times Cr \geq 20 Ω .F:
 0201 : 2.2 μ F to 4.7 μ F
 0402 : 22 μ F
 0603 : 47 μ F

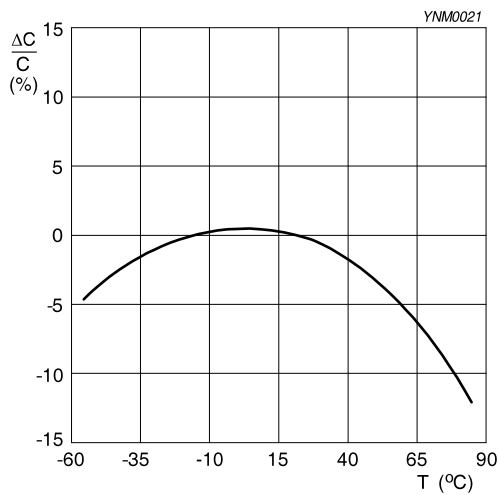

Fig. 3 Typical capacitance change as a function of temperature

Size 0201 10 nF / 16 V
 Solid lines: Impedance / Dotted lines: ESR

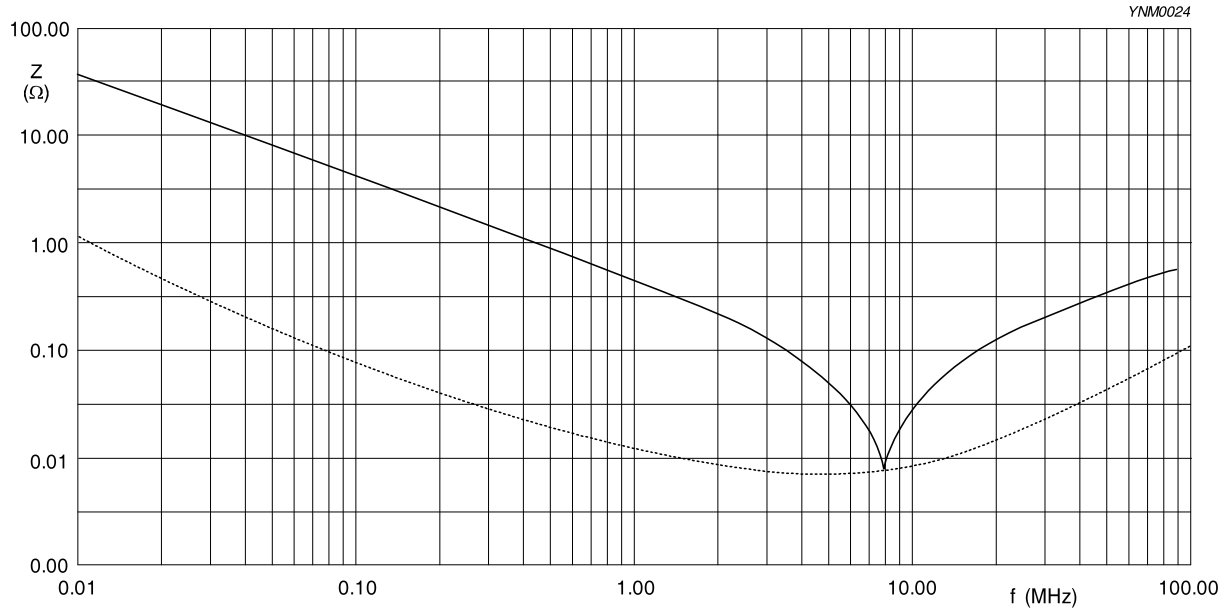

Fig. 4 Impedance ESR vs. frequency characteristics for multilayer chip capacitors

Size 0603 1 μF / 10 V
 Solid lines: Impedance / Dotted lines: ESR

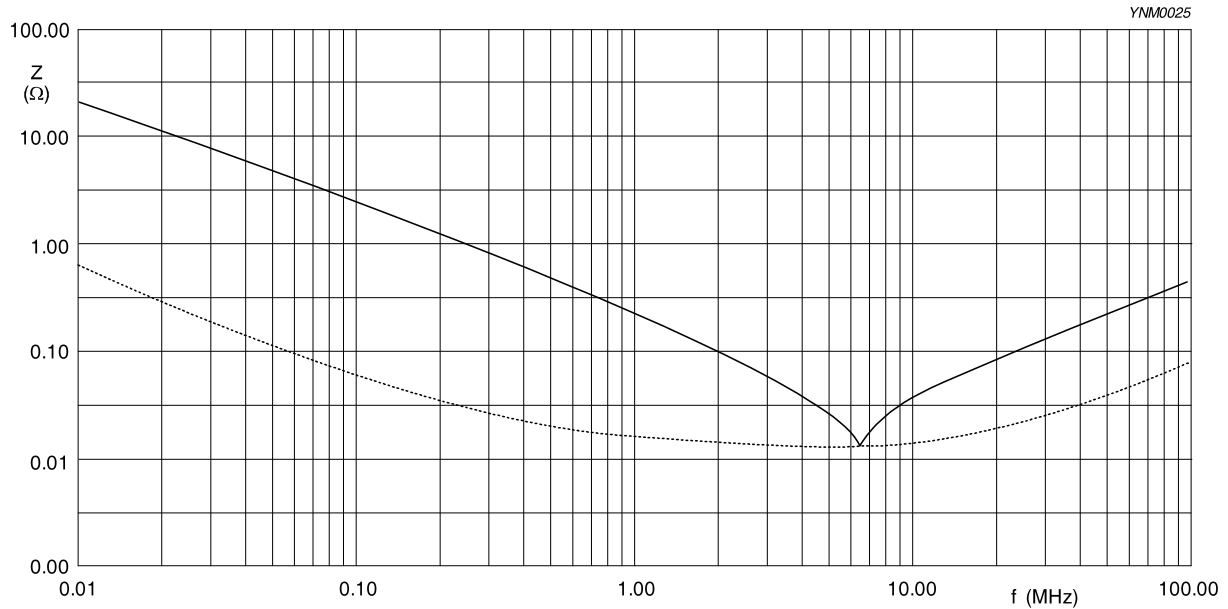

Fig. 5 Impedance ESR vs. frequency characteristics for multilayer chip capacitors

Size 0805 10 μ F / 6.3 V
Solid lines: Impedance / Dotted lines: ESR

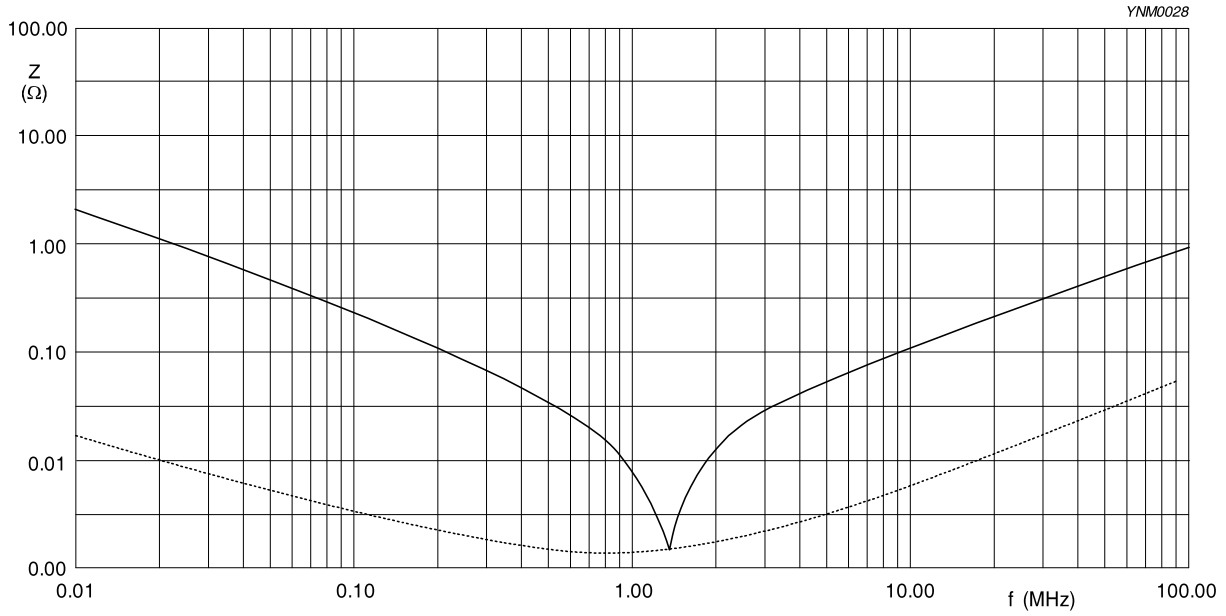

Fig. 6 Impedance ESR vs. frequency characteristics for multilayer chip capacitors

Size 1206 10 μ F / 16 V
Solid lines: Impedance / Dotted lines: ESR

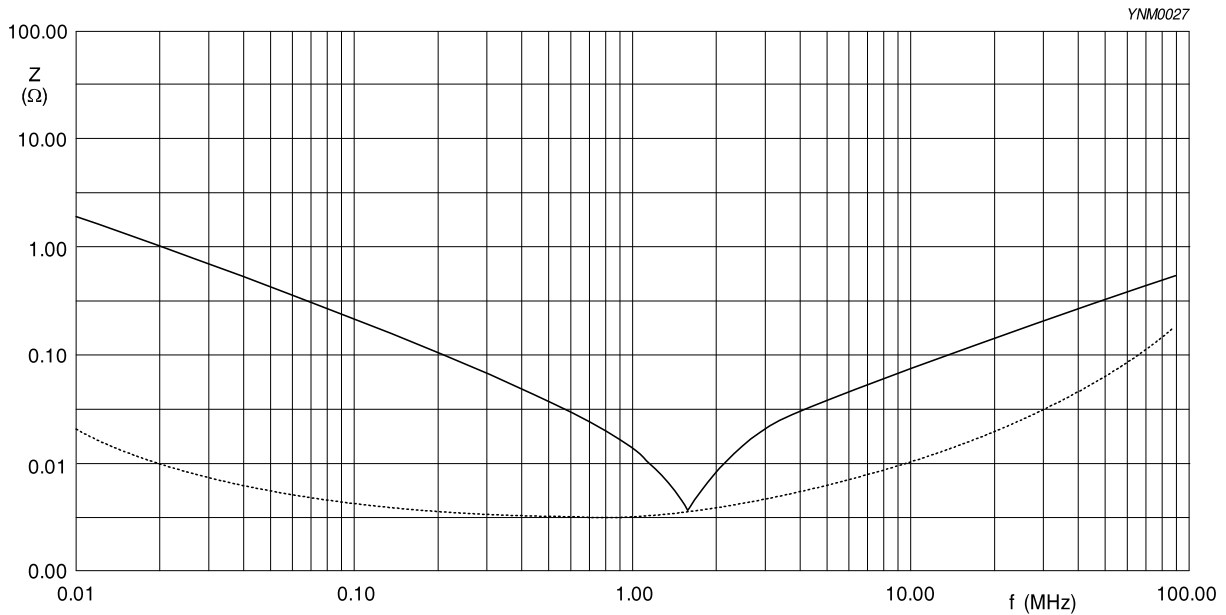
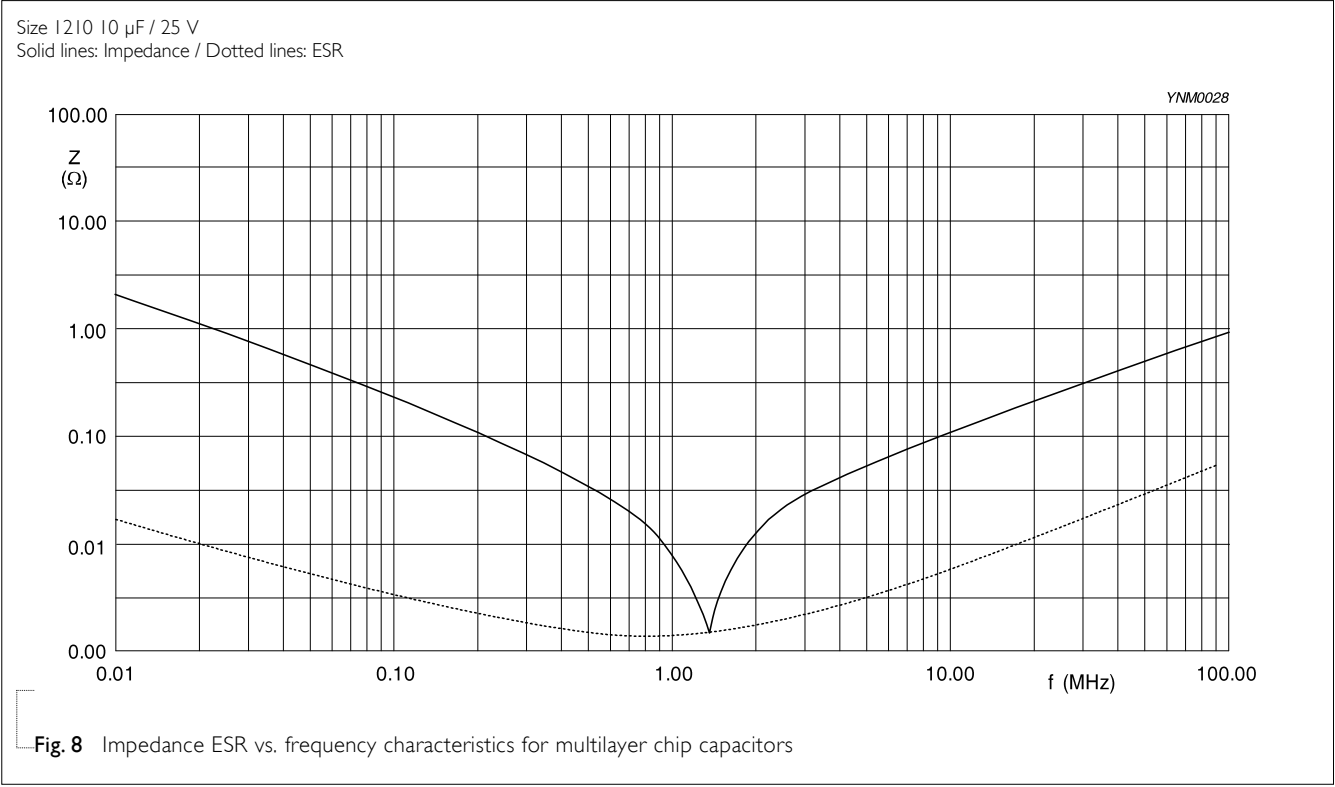

Fig. 7 Impedance ESR vs. frequency characteristics for multilayer chip capacitors



SOLDERING RECOMMENDATION

Table 7

| SOLDERING METHOD | SIZE | | | | | |
|------------------|-------------|----------|-------------|---------------|---------------|-------------|
| | 0201 | 0402 | 0603 | 0805 | 1206 | ≥ 1210 |
| Reflow | Reflow only | > 100 nF | > 1 μ F | > 2.2 μ F | > 2.2 μ F | Reflow only |
| Reflow/Wave | | ≤ 100 nF | ≤ 1 μ F | ≤ 2.2 μ F | ≤ 2.2 μ F | --- |

TESTS AND REQUIREMENTS
Table 8 Test procedures and requirements

| TEST | TEST METHOD | PROCEDURE | REQUIREMENTS |
|--|---------------------|--|----------------------------------|
| Mounting | IEC 60384-21/22 4.3 | The capacitors may be mounted on printed-circuit boards or ceramic substrates | No visible damage |
| Visual Inspection and Dimension Check | 4.4 | Any applicable method using $\times 10$ magnification | In accordance with specification |
| Capacitance ⁽¹⁾ | 4.5.1 | Class 2: | Within specified tolerance |
| Dissipation Factor (D.F.) ⁽¹⁾ | 4.5.2 | At 20 °C, 24 hrs after annealing Cap $\leq 1 \mu\text{F}$, $f = 1 \text{ KHz}$, measuring at voltage 1 Vrms at 20 °C Cap $> 1 \mu\text{F}$, $f = 1 \text{ KHz}$ for $C \leq 10 \mu\text{F}$, rated voltage $> 6.3 \text{ V}$, measuring at voltage 1 Vrms at 20 °C $f = 1 \text{ KHz}$, for $C \leq 10 \mu\text{F}$, rated voltage $\leq 6.3 \text{ V}$, measuring at voltage 0.5 Vrms at 20 °C $f = 120 \text{ Hz}$ for $C > 10 \mu\text{F}$, measuring at voltage 0.5 Vrms at 20 °C | |
| Insulation Resistance | 4.5.3 | At U_r (DC) for 1 minute | In accordance with specification |

NOTE

1. The figure indicates typical inspection. Please refer to individual specifications.

| TEST | TEST METHOD | PROCEDURE | REQUIREMENTS | | | | | | | | | | | | |
|----------------------------|-----------------------|--|---|-----------------|---|------|---|-----------------------|---|------|---|-----------------------|---|------|---|
| Temperature Characteristic | 4.6 | <p>Capacitance shall be measured by the steps shown in the following table.</p> <p>The capacitance change should be measured after 5 min at each specified temperature stage.</p> <table border="1"> <thead> <tr> <th>Step</th> <th>Temperature(°C)</th> </tr> </thead> <tbody> <tr> <td>a</td> <td>25±2</td> </tr> <tr> <td>b</td> <td>Lower temperature±3°C</td> </tr> <tr> <td>c</td> <td>25±2</td> </tr> <tr> <td>d</td> <td>Upper Temperature±2°C</td> </tr> <tr> <td>e</td> <td>25±2</td> </tr> </tbody> </table> <p>(1) Class I</p> <p>Temperature Coefficient shall be calculated from the formula as below</p> $\text{Temp. Coefficient} = \frac{C2 - C1}{C1 \times \Delta T} \times 10^6 \text{ [ppm/°C]}$ <p>C1: Capacitance at step c C2: Capacitance at 125°C ΔT: 100°C(=125°C-25°C)</p> <p>(2) Class II</p> <p>Capacitance Change shall be calculated from the formula as below</p> $\Delta C = \frac{C2 - C1}{C1} \times 100\%$ <p>C1: Capacitance at step c C2: Capacitance at step b or d</p> | Step | Temperature(°C) | a | 25±2 | b | Lower temperature±3°C | c | 25±2 | d | Upper Temperature±2°C | e | 25±2 | <p><General purpose series></p> <p>Class1: Δ C/C: ±30ppm</p> <p>Class2: X7R: Δ C/C: ±15% Y5V: Δ C/C: 22~-82%</p> <p><High Capacitance series></p> <p>Class2: X7R/X5R: Δ C/C: ±15% Y5V: Δ C/C: 22~-82%</p> |
| Step | Temperature(°C) | | | | | | | | | | | | | | |
| a | 25±2 | | | | | | | | | | | | | | |
| b | Lower temperature±3°C | | | | | | | | | | | | | | |
| c | 25±2 | | | | | | | | | | | | | | |
| d | Upper Temperature±2°C | | | | | | | | | | | | | | |
| e | 25±2 | | | | | | | | | | | | | | |
| Adhesion | 4.7 | <p>A force applied for 10 seconds to the line joining the terminations and in a plane parallel to the substrate</p> | <p>Force</p> <p>size ≥ 0603: 5N size = 0402: 2.5N size = 0201: 1N</p> | | | | | | | | | | | | |

| | | | | |
|------------------|-----------------|-----|--|-------------------|
| Bending Strength | IEC 60384-21/22 | 4.8 | Mounting in accordance with IEC 60384-22 paragraph 4.3 | No visible damage |
|------------------|-----------------|-----|--|-------------------|

Conditions: bending 1 mm at a rate of 1 mm/s, radius jig 5 mm

Test Substrate:

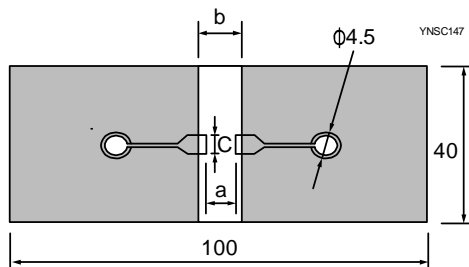

Unit: mm

| Dimension(mm) | | | |
|---------------|-----|-----|------|
| Type | a | b | c |
| 0201 | 0.3 | 0.9 | 0.3 |
| 0402 | 0.4 | 1.5 | 0.5 |
| 0603 | 1.0 | 3.0 | 1.2 |
| 0805 | 1.2 | 4.0 | 1.65 |
| 1206 | 2.2 | 5.0 | 1.65 |
| 1210 | 2.2 | 5.0 | 2.0 |

| TEST | TEST METHOD | PROCEDURE | REQUIREMENTS |
|------------------------------|-----------------|--|---|
| Resistance to Soldering Heat | 4.9 | Precondition: 150 +0/-10 °C for 1 hour, then keep for 24 ±1 hours at room temperature Preheating: for size ≤ 1206: 120 °C to 150 °C for 1 minute Preheating: for size > 1206: 100 °C to 120 °C for 1 minute and 170 °C to 200 °C for 1 minute Solder bath temperature: 260 ±5 °C Dipping time: 10 ±0.5 seconds Recovery time: 24 ±2 hours | Dissolution of the end face plating shall not exceed 25% of the length of the edge concerned <hr/> <General purpose series> ΔC/C Class2: X5R: ±10% <hr/> <High Capacitance series> ΔC/C Class2: X5R: ±10% <hr/> D.F. within initial specified value R _{ins} within initial specified value |
| Solderability | 4.10 | Preheated the temperature of 80 °C to 140 °C and maintained for 30 seconds to 60 seconds. 1. Temperature: 235±5°C / Dipping time: 2 ±0.5 s 2. Temperature: 245±5°C / Dipping time: 3 ±0.5 s (lead free) Depth of immersion: 10mm | The solder should cover over 95% of the critical area of each termination |
| Rapid Change of Temperature | IEC 60384-21/22 | 4.11 Preconditioning: 150 +0/-10 °C for 1 hour, then keep for 24 ±1 hours at room temperature 5 cycles with following detail: 30 minutes at lower category temperature 30 minutes at upper category temperature Recovery time 24 ±2 hours | No visual damage <hr/> <General purpose series> ΔC/C Class2: X5R: ±15% <hr/> <High Capacitance series> ΔC/C Class2: X5R: ±15% <hr/> D.F. meet initial specified value R _{ins} meet initial specified value |

| TEST | TEST METHOD | PROCEDURE | REQUIREMENTS |
|---------------------------|-------------|---|---|
| Damp Heat with U_r Load | 4.13 | <p>1. Preconditioning, class 2 only: 150 +0/-10 °C /1 hour, then keep for 24 ±1 hour at room temp</p> <p>2. Initial measure: Spec: refer to initial spec C, D, IR</p> <p>3. Damp heat test: 500 ±12 hours at 40 ±2 °C; 90 to 95% R.H. 1.0 U_r applied</p> <p>4. Recovery: Class 2: 24 ±2 hours</p> <p>5. Final measure: C, D, IR</p> <p>P.S. If the capacitance value is less than the minimum value permitted, then after the other measurements have been made the capacitor shall be preconditioned according to "IEC 60384 4.1" and then the requirements shall be met.</p> <p>* General product: 0201 < 100nF 0402 < 1uF 0603 < 2.2uF 0805, 1206, 1210 < 4.7uF</p> <p>* High cap product: 0201 ≥ 100nF 0402 ≥ 1uF 0603 ≥ 2.2uF 0805, 1206, 1210 ≥ 4.7uF</p> | <p>No visual damage after recovery</p> <p><General purpose series></p> <p>$\Delta C/C$</p> <p>Class2: X5R: ±15%</p> <p>D.F.</p> <p>Class2: X5R:</p> <p>≤ 16V: ≤ 7% or 2 x initial value whichever is greater</p> <p>≥ 25V: ≤ 5% or 2 x initial value whichever is greater</p> <p>R_{ins}</p> <p>Class2: X5R: ≥ 500 MΩ or $R_{ins} \times C_r \geq 25s$ whichever is less</p> <p><High Capacitance series></p> <p>$\Delta C/C$</p> <p>Class2: X5R: ±20%</p> <p>D.F.</p> <p>Class2: X5R: 2 x initial value max</p> <p>R_{ins}</p> <p>Class2: $R_{ins} \times C_r \geq 5s$ whichever is less</p> |

| TEST | TEST METHOD | PROCEDURE | REQUIREMENTS |
|---------------|-----------------------|--|--|
| Endurance | IEC 60384- 21/22 4.14 | <p>1. Preconditioning, class 2 only: 150 +0/-10 °C /1 hour, then keep for 24 ±1 hour at room temp</p> <p>2. Initial measure: Spec: refer to initial spec C, D, IR</p> <p>3. Endurance test: Temperature: X5R: 85 °C Specified stress voltage applied for 1,000 hours: Applied 2.0 × Ur for general product*. Applied 1.5 × Ur for high cap. product*. Applied 1.0 × Ur for high cap. product*.</p> <p>4. Recovery time: 24 ±2 hours</p> <p>5. Final measure: C, D, IR</p> <p>P.S. If the capacitance value is less than the minimum value permitted, then after the other measurements have been made the capacitor shall be preconditioned according to "IEC 60384 4.1" and then the requirements shall be met.</p> <p>* General product (Applied 2.0 × Ur): 0201 < 100nF 0402 < 1uF 0603 < 2.2uF 0805, 1206, 1210 < 4.7uF</p> <p>* High cap product (Applied 1.5 × Ur): 0201 ≥ 100nF 0402 ≥ 1uF 0603 ≥ 2.2uF 0805, 1206, 1210 ≥ 4.7uF</p> <p>* High cap product (Applied 1.0 × Ur): 0201: 100nF/25V, 2.2uF to 4.7uF 0402: 4.7uF to 22uF 0603: 10uF/10V to 25V 22uF to 47uF 0805: 10uF/ 25V, 50V, 22uF to 100uF 1206: 10uF/ 50V</p> | <p>No visual damage</p> <hr/> <p><General purpose series></p> <p>ΔC/C Class2: X5R: ±15% D.F. Class2: X5R: ≤ 16V: ≤ 7% or 2 × initial value whichever is greater ≥ 25V: ≤ 5% or 2 × initial value whichever is greater R_{ins} Class2: X5R: ≥ 1,000 MΩ or R_{ins} × C_r ≥ 50s whichever is less</p> <p><High Capacitance series></p> <p>ΔC/C Class 2: X5R: ±20% D.F. Class 2: X5R: 2 × initial value max R_{ins} Class 2: R_{ins} × C_r ≥ 10s whichever is less</p> |
| Voltage Proof | 4.6 | <p>Specified stress voltage applied for 1~5 seconds</p> <p>Ur ≤ 100 V: series applied 2.5 Ur 100 V < Ur ≤ 200 V series applied (1.5 Ur + 100)</p> <p>200 V < Ur ≤ 500 V series applied (1.3 Ur + 100)</p> <p>Ur > 500 V: 1.3 Ur Ur ≥ 1000 V: 1.2 Ur</p> <p>Charge/Discharge current is less than 50 mA</p> | No breakdown or flashover |

REVISION HISTORY

| REVISION | DATE | CHANGE NOTIFICATION | DESCRIPTION |
|------------|---------------|---------------------|---|
| Version 25 | Jun. 2, 2017 | - | - I.R spec updated |
| Version 24 | Mar. 6, 2017 | - | - 0805 L4 spec updated |
| Version 23 | Nov. 15, 2016 | - | - Dimension updated |
| Version 22 | Oct. 3, 2016 | - | - Dimension and Soldering recommendation updated |
| Version 21 | Jan. 28, 2016 | - | - Tests and requirements updated |
| Version 20 | Dec. 04, 2015 | - | - Size updated |
| Version 19 | Apr. 09, 2015 | - | - Voltage updated |
| Version 18 | Jul. 07, 2014 | - | - Voltage updated |
| Version 17 | Mar. 31, 2014 | - | - Test condition updated |
| Version 16 | Nov. 29, 2012 | - | - Test condition updated |
| Version 15 | Sep. 03, 2012 | - | - Test condition updated |
| Version 14 | May 16, 2012 | - | - Product range updated |
| Version 13 | May 02, 2012 | - | - Product range updated |
| Version 12 | Feb 10, 2012 | - | - Product range updated |
| Version 11 | Oct 21, 2011 | - | - Product range updated |
| Version 10 | Jun 21, 2011 | - | - Product range updated |
| Version 9 | Mar 23, 2011 | - | - Product range updated |
| Version 8 | Jan 25, 2011 | - | - Rated voltage of 0201 extend to 50V |
| Version 7 | Jan 05, 2011 | - | - Product range updated |
| Version 6 | Jul 27, 2010 | - | - Dimension on 0603 and 1206 case size updated |
| Version 5 | Apr 21, 2010 | - | - The statement of "Halogen free" on the cover added - Dimension updated |
| Version 4 | Jan 13, 2010 | - | - Thickness updated |
| Version 3 | Aug 17, 2009 | - | - Dimension updated |
| Version 2 | Jun 09, 2009 | - | - Ordering code updated |
| Version 1 | May 15, 2009 | - | - Product range updated |
| Version 0 | Apr 15, 2009 | - | - New datasheet for general purpose and high capacitance X5R series with RoHS compliant - Replace the "6.3V to 50V" part of pdf files: UP-X5R_X7R_HighCaps_6.3-to-25V_11, UY-X5R_X7R_HighCaps_6.3-to-25V_11 - Combine 0201 from pdf files: UP-NP0X5RX7RY5V_0201_6.3-to-50V_2 and UY-NPOX5RX7RY5V_0201_6.3-to-50V_2 - Define global part number - Description of "Halogen free compliant" added - Test method and procedure updated |