



DATASHEET -Preliminary-

Surface Acoustic Wave Filter

- **Application : LTE Band 8**
- **Model : SFX897BYF02**
- **Center Frequency : 897.5 / 942.5 [MHz]**



WISOL CO., LTD.

373-7, GAJANG-DONG, OSAN-SI
GYUNGGI-DO, KOREA, 447-210

<http://www.wisol.co.kr>

E-mail: sales@wisol.co.kr

1. OUTLINE DRAWING & RECOMMENDED PCB

[Unit: mm]

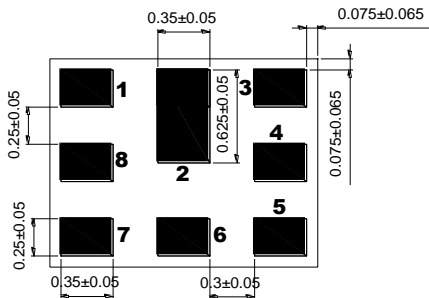
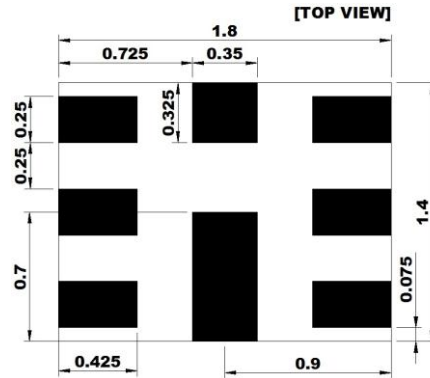
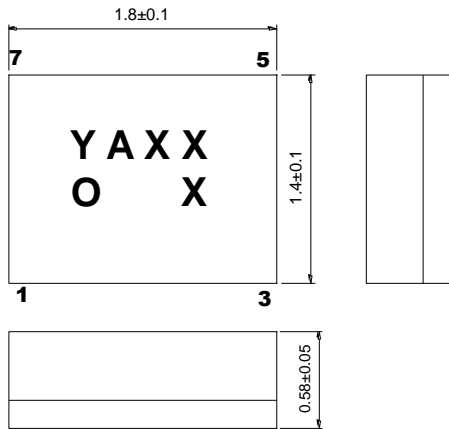

No.	Function
1	Rx Output
3	Tx Input
6	Antenna
2, 4, 5, 7, 8	GND

2. TEST FIXTURE

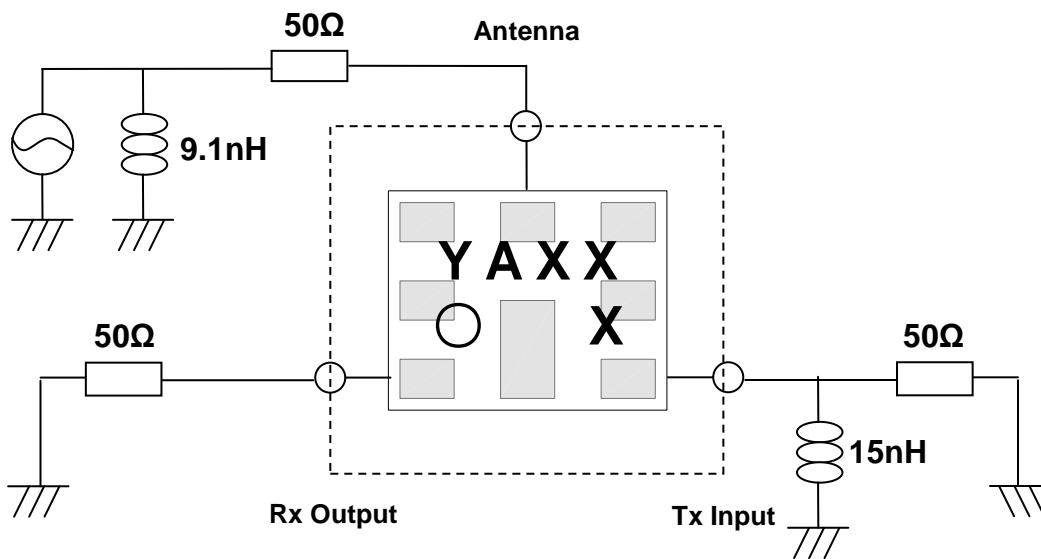

3. PERFORMANCE

3-1. MAXIMUM RATINGS

CHARACTERISTICS	RATINGS	UNITS
DC Permissive Voltage	5	V
Maximum Input Power	0.8	W
Operating Temperature Range	- 20 ~ + 85	°C
Storage Temperature Range	- 40 ~ + 85	°C

3-2. ELECTRICAL CHARACTERISTICS

3-2-1. TABLE

Ta = - 20 ~ + 85 °C

Item	CONDITION [MHz]	UNIT	RATING		
			Min.	Typ.(25 °C)	Max.
TX → ANTENNA					
Insertion Loss	880.24 ~ 914.76	dB	-	2.1	3.6
	882.4 ~ 912.6	dB	-	1.8	2.5
Inband Ripple	880.24 ~ 914.76	dB	-	1.1	2.8
	882.4 ~ 912.6	dB	-	0.8	1.7
VSWR	880 ~ 915	-	-	1.9	2.3
Absolute Attenuation	10 ~ 830	dB	23	27	-
	927.4 ~ 957.6	dB	44	53	-
	970~1005	dB	23	30	-
	1572 ~1579	dB	31	36	-
	2110~2170	dB	33	38	-
	2400~2500	dB	28	33	-
	2640~2745	dB	20	27	-
4400~4575	dB	5	13	-	
Termination Impedance : INPUT / ANTENNA		50Ω // 15[nH] /50Ω // 9.1[nH]			
ANTENNA → RX					
Insertion Loss	925 ~ 960	dB	-	2.3	3.5
	927.4 ~ 957.6	dB	-	2.0	2.5
Inband Ripple	925 ~ 960	dB	-	0.9	2.3
	927.4 ~ 957.6	dB	-	0.6	1.3
VSWR	925 ~ 960	-	-	1.8	2.2

Absolute Attenuation	10~880	dB	55	62	-
	880 ~ 915	dB	47	57	-
	980~1785	dB	22	30	-
	1805~1920	dB	50	61	-
	1980~3000	dB	45	52	-
	3000~6000	dB	28	35	-
Termination Impedance : ANT / OUTPUT			50Ω // 9.1[nH] /50Ω		
TX → RX					
Isolation between Rx and Tx	880 ~ 915	dB	55	60	-
	927.4 ~ 957.6	dB	50	56	-

3-2-2. GRAPH

3-2-2-1. Tx→Ant, Ant→Rx Transmission Characteristics

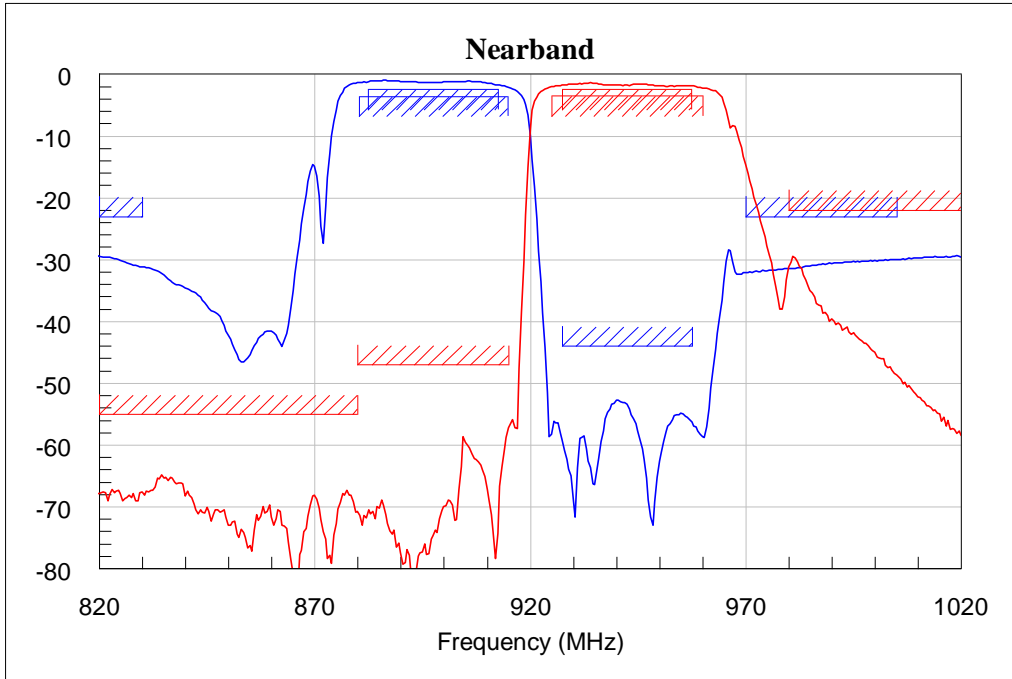

3-2-2-2. Tx→Rx Isolation Characteristics

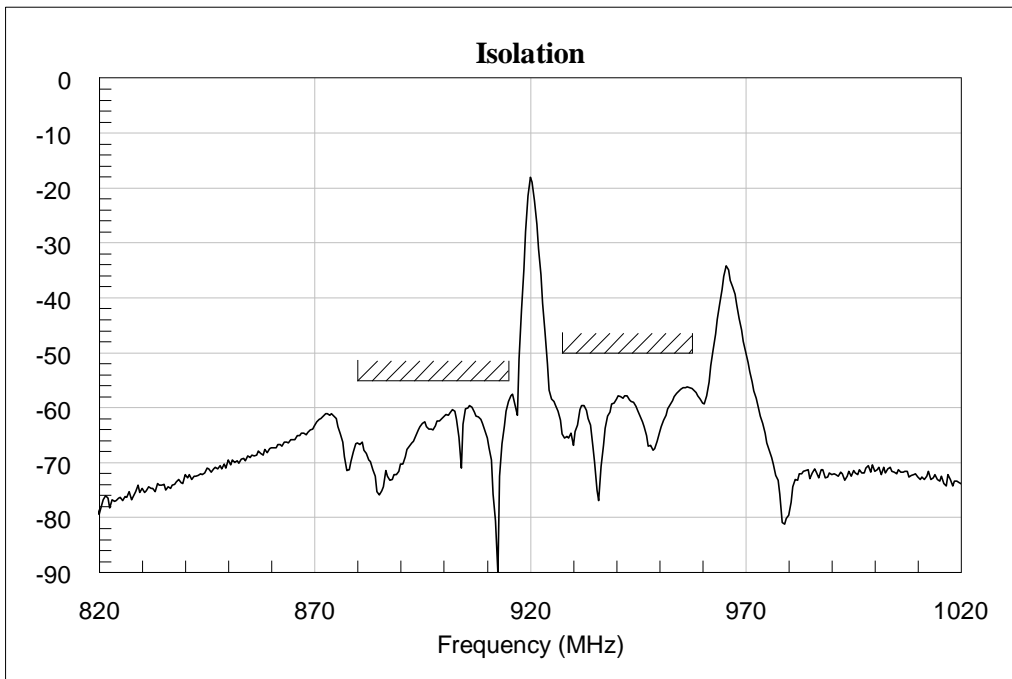

3-2-2-3. Wideband Tx→Ant, Ant→Rx Transmission Characteristics

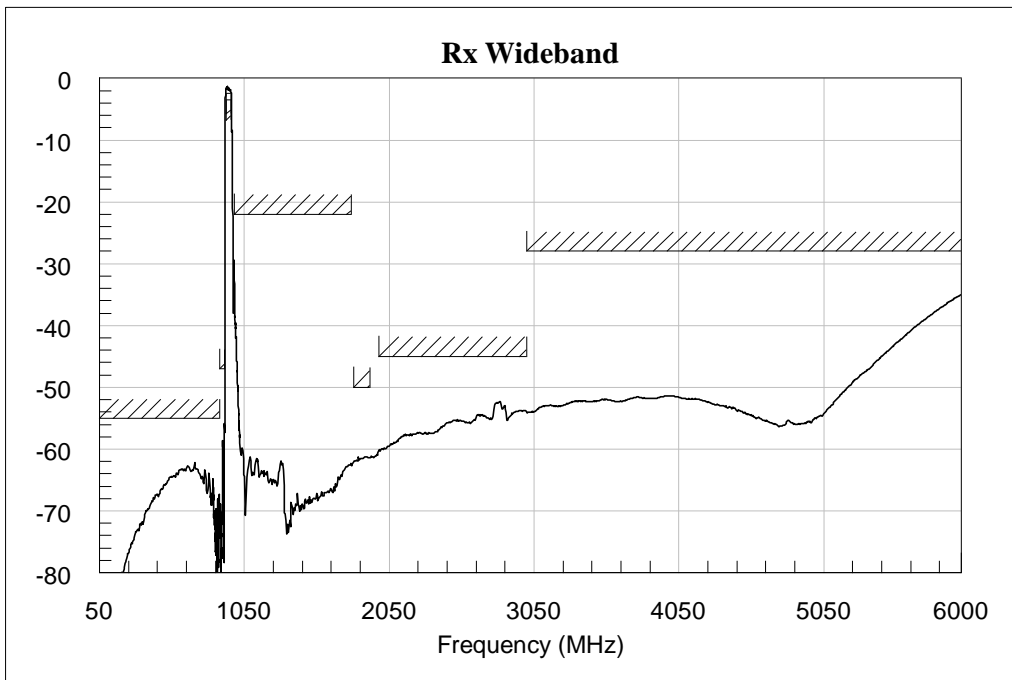
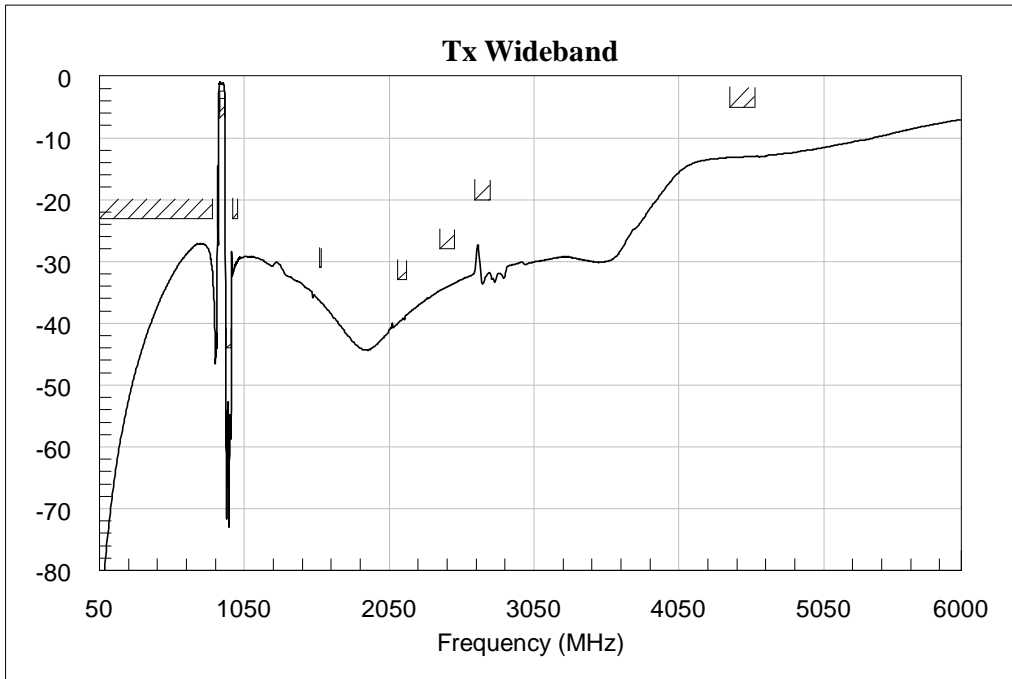

3-2-2-4. Wideband Tx→Rx Transmission Characteristics

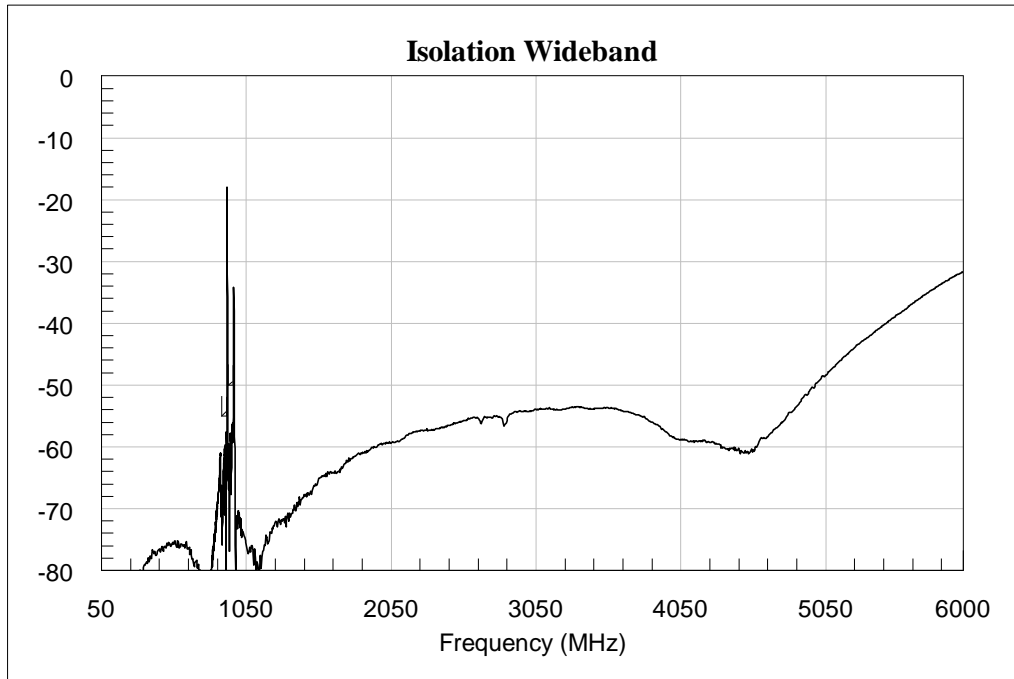

b

3-2-2-5. Smithchart

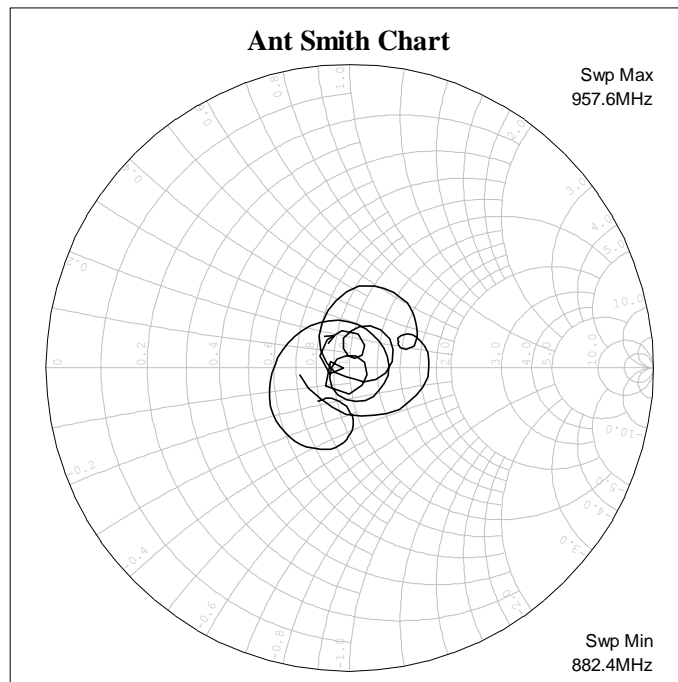

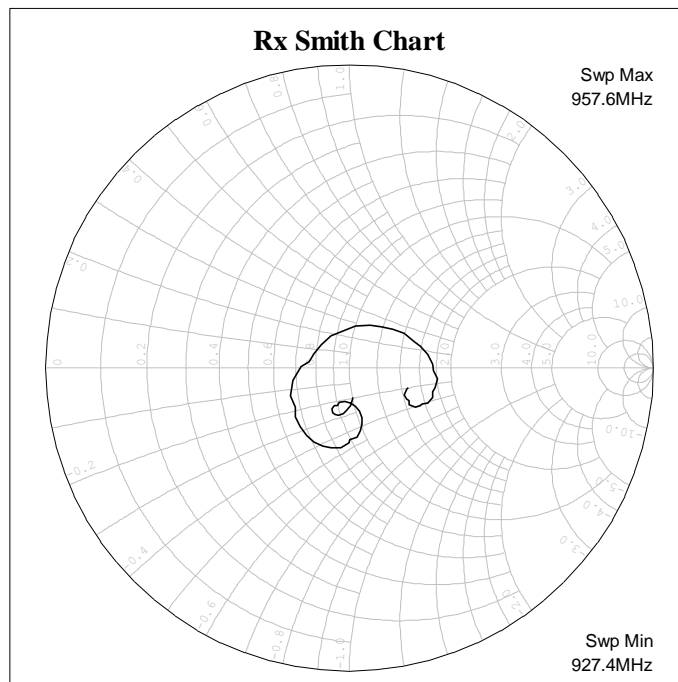
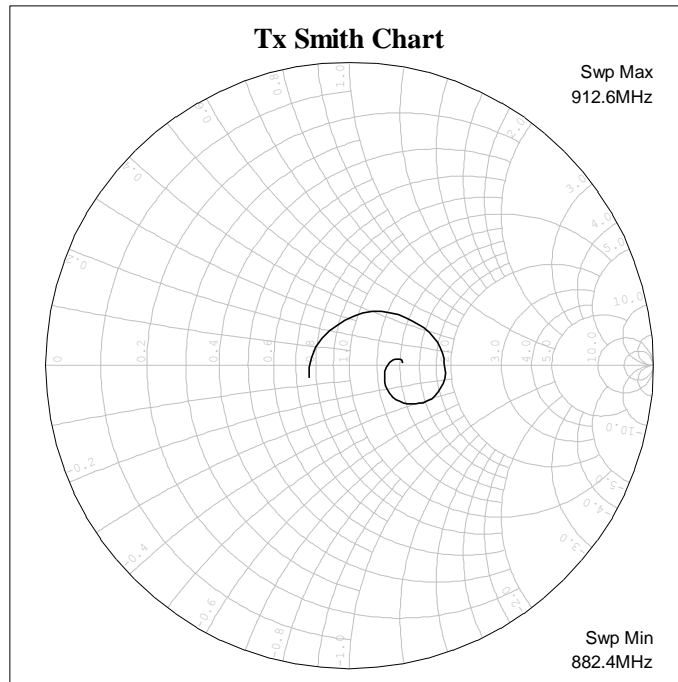

4. PACKING

4-1. DIMENSIONS

- Carrier Tape [Unit: mm]

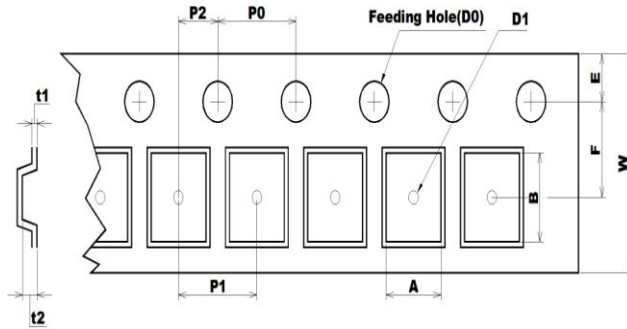

A	B	D0	D1
1.70 +0.10 -0.10	2.1 +0.10 -0.10	Ø1.55 +0.05 -0.05	Ø1.00 MIN
E	F	P0	P1
1.75 +0.10 -0.10	3.5 +0.05 -0.05	4 +0.10 -0.10	4 +0.10 -0.10
P2	t1	t2	W
2 +0.05 -0.05	0.25 +0.05 -0.05	0.70 +0.10 -0.10	8 +0.30 -0.30

- Reel [Unit: mm]

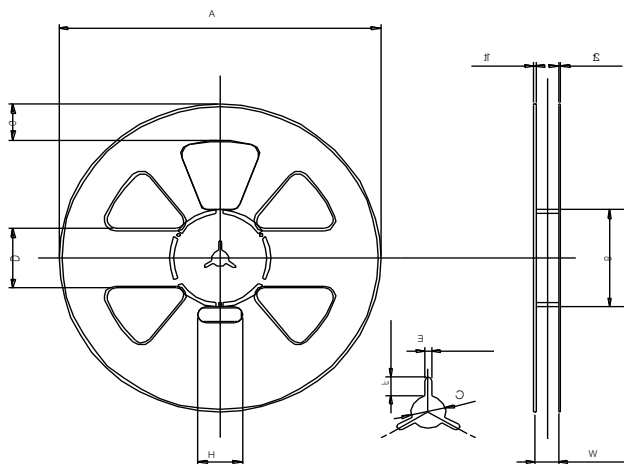

A	B	C	D
Ø258.0 +1.0 -0.5	Ø81.0 +1.0 -1.0	Ø13.0 +0.5 -0.5	50.0 +0.8 -0.8
E	F	G	H
2.2 +0.3 -0.3	7.0 +0.5 -0.5	30.0 +0.8 -0.8	35.0 +1.0 -1.0
t1	t2	W	
1.8 +0.5 -0.5	1.5 +0.5 -0.5	9.0 +1.0 -0.5	

- The product shall be packed properly not to be damaged during transportation and storage.

4-2. REELING QUANTITY

10 inch reel: 8,000 pcs/reel

4-3. TAPING STRUCTURE

The tape shall be wound around the reel in direction shown below.

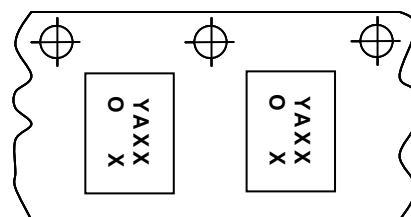
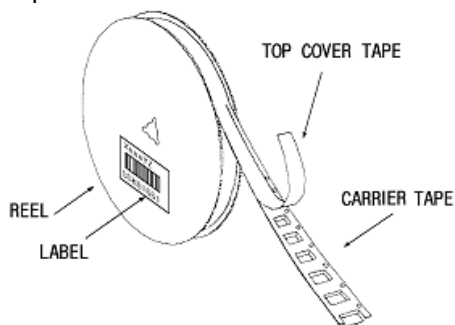

Tape Running direction

