



ISO14001



ISO/TS16949



244546



245468



REG.-Nr.A759



CQC04001010058



Specification for Approval

Customer : 深圳市立创电子商务有限公司

Product Name : LEAD-FREE THICK FILM CHIP RESISTORS (LE)

Part Name : LE03、LE05、LE06 ±0.5%、±1%、±2%、±5% & 0Ω

Part No. : LE*****T5E

88 Longteng Road, Economic & Technical Development Zone, Kunshan City, Jiangsu, China

TEL: 86 512 57631411 / 22 / 33

FAX: 86 512 57631431

E-mail: globalsales@uniohm.com localsales@uniohm.com

Approved	Checked	Prepared	File NO.	Edition	Date	Page
William Zhao	Apple Liu	Wu Yiyun	JLC-01-007	1	2016/3/15	1/11



Content

Introduction Page

1.0 Scope 4

2.0 Ratings & Dimension 4

3.0 Structure 5

4.0 Marking 5

5.0 Derating Curve 6

6.0 Performance Specification 7

7.0 Explanation of Part No. System 8

8.0 Ordering Procedure 9

9.0 Standard Packing 10

10.0 Note 11

Approved	Checked	Prepared	File NO.	Edition	Date	Page
William Zhao	Apple Liu	Wu Yiyun	JLC-01-007	1	2016/3/15	2/11



ISO14001

ISO/TS16949

244546

245468

REG.-Nr.A759

CQC04001010058

File Name: LE03、LE05、LE06 ±0.5%, ±1%,±2%,±5% & 0Ω		Date	2016/3/15	Edition No.	1
Amendment Record				Signature	
Edition	Prescription of amendment	Amend Page	Amend Date	Amended by	Checked by

Approved	Checked	Prepared	File NO.	Edition	Date	Page
William Zhao	Apple Liu	Wu Yiyun	JLC-01-007	1	2016/3/15	3/11

1.0 Scope:

Flex LED Strip use Thick Film Chip Resistors, This product looks like a tape, plus the original is LED products. This specification for approve relates to the Lead-Free Thick Film Chip Resistors (LE03、LE05、LE06) manufactured by UNIOHM.

2.0 Ratings & Dimension:

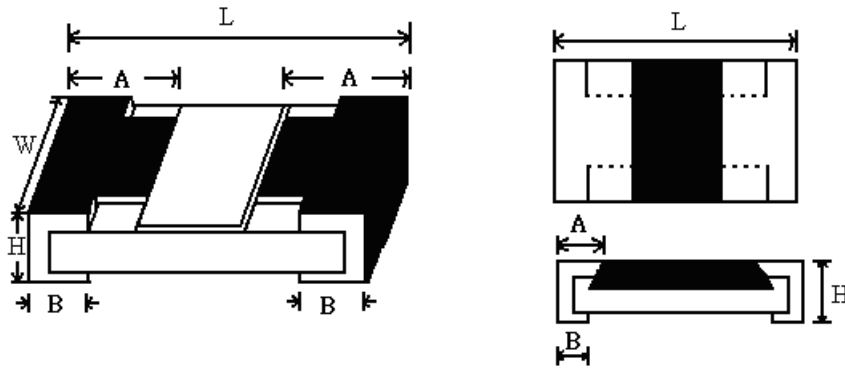

Unit: mm

Type		LE03	LE05	LE06
Power Rating at 70°C		1/16W(1/10WS)	1/10W、1/8W-S	1/8W(1/4WS)
Dimension(mm)	L	1.60±0.10	2.00±0.15	3.10±0.15
	W	0.80±0.10	1.25+0.15/-0.10	1.55+0.15/-0.10
	H	0.45±0.10	0.55±0.10	0.55±0.10
	A	0.30±0.20	0.40±0.20	0.45±0.20
	B	0.30±0.20	0.40±0.20	0.45±0.20
Max Working Voltage		75V	150V	200V
Max Overload Voltage		150V	300V	400V
Dielectric Withstanding Voltage		300V	500V	500V
Resistance Range		1Ω~10MΩ、0Ω		
Tolerance		±0.5%、±1%、±2%、±5%		
Operating Temperature		-55°C ~ +155°C		

Approved	Checked	Prepared	File NO.	Edition	Date	Page
William Zhao	Apple Liu	Wu Yiyun	JLC-01-007	1	2016/3/15	4/11

3.0 Structure:

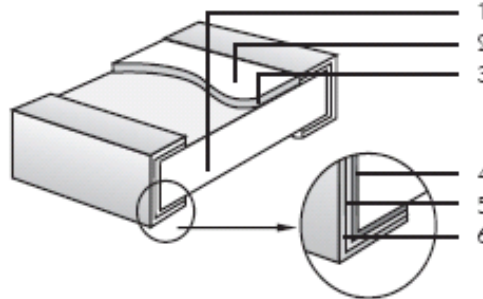

1. High purity alumina substrate
2. Protective covering
3. Resistance element
4. Termination (inner) Ni/Cr
5. Termination (between) Ni Barrier
6. Termination (outer) Sn

4.0 Marking:

(1) $\pm 2\%$ 、 $\pm 5\%$ Tolerance: The first two digits are significant figures of resistance and the third denotes number of zeros following

Example:

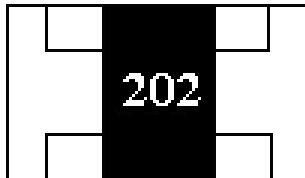

202=2K Ω

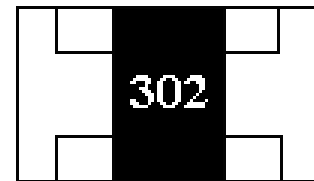

302=3K Ω

(2) $\pm 0.5\%$ 、 $\pm 1\%$ Tolerance: 4 digits, first three digits are significant; fourth digit is number of zeros. Letter r is decimal point.

Example:



2701 \rightarrow 2.7K Ω

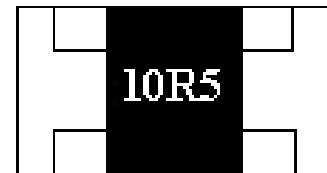

10R5 \rightarrow 10.5 Ω

Approved	Checked	Prepared	File NO.	Edition	Date	Page
William Zhao	Apple Liu	Wu Yiyun	JLC-01-007	1	2016/3/15	5/11

5.0 Derating Curve:

Resistors shall have a power rating based on continuous load operation at an ambient temperature from -55°C to 70°C. For temperature in excess of 70°C, the load shall be derate as shown in figure 1

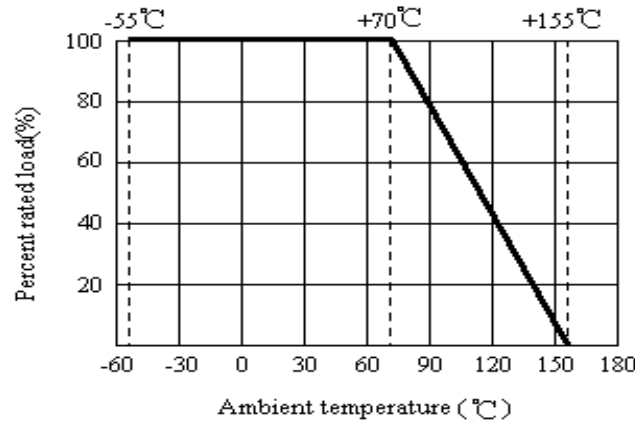

5.1 Voltage rating:

Resistors should have a direct-current (DC) continuous voltage rating and an alternating-current (AC) continuous voltage rating relates to Power Rating, formula shown as below:

$$RCWV = \sqrt{P * R}$$

RCWV: Rated dc or RMS ac continuous working voltage at commercial-line frequency and waveform (Volt.)

P: Power Rating (Watt.)

R: Nominal Resistance (Ohm)

Resistors will be burned out if it overload, such as higher than the maximum value of series' RCWV.

And we named 2.5 times RCWV is OVERLOAD Voltage.

Approved	Checked	Prepared	File NO.	Edition	Date	Page
William Zhao	Apple Liu	Wu Yiyun	JLC-01-007	1	2016/3/15	6/11



ISO14001



ISO/TS16949



244546



245468



REG.-Nr.A759



CQC04001610656

6.0 Performance Specification:

Characteristic	Limits		Test Method (JIS-C-5201& JIS-C-5202)															
Temperature Coefficient	$1\Omega \leq R \leq 10\Omega \leq \pm 400\text{PPM}/^\circ\text{C}$ $10\Omega < R \leq 100\Omega \leq \pm 200\text{PPM}/^\circ\text{C}$ $100\Omega < R \leq 10\text{M}\Omega \leq \pm 100\text{PPM}/^\circ\text{C}$		4.8 Natural resistance changes per temp. Degree centigrade $\frac{R_2 - R_1}{R_1(T_2 - T_1)} \cdot 10^6 (\text{PPM}/^\circ\text{C})$ R1: resistance value at room temp. (T ₁) R2: resistance value at room temp. +100°C (T ₂) Test pattern: room temp. (T ₁), room temp. +100°C(T ₂)															
Short-time overload	±2%、±5%	±(2%+0.1Ω) Max.	4.13 Permanent resistance change after the application of a potential of 2.5 times RCWV or Max. Overload Voltage whichever less for 5 seconds.															
	±0.5%、±1%	±(1%+0.1Ω) Max.																
Dielectric withstanding voltage	No evidence of flashover mechanical damage, arcing or insulation breaks down.		4.7 Resistors shall be clamped in the trough of a 90°metallic v-block and shall be tested at ac potential respectively specified in the given list of each product type for 60-70 seconds.															
Solderability	95% coverage Min.		Wave solder: Test temperature of solder: 245°C±3°C dipping time in solder: 2-3 seconds.															
	Go up tin rate bigger than half of end pole		Reflow: 															
Temperature cycling	±2%、±5%	±(1.0%+0.05 Ω) Max	4.19 Resistance change after continuous five cycles for duty cycle specified below: <table border="1"> <thead> <tr> <th>Step</th> <th>Temperature</th> <th>Time</th> </tr> </thead> <tbody> <tr> <td>1</td> <td>-55°C±3°C</td> <td>30mins</td> </tr> <tr> <td>2</td> <td>Room temp.</td> <td>10 --- 15mins</td> </tr> <tr> <td>3</td> <td>+155°C±2°C</td> <td>30mins</td> </tr> <tr> <td>4</td> <td>Room temp.</td> <td>10 --- 15mins</td> </tr> </tbody> </table>	Step	Temperature	Time	1	-55°C±3°C	30mins	2	Room temp.	10 --- 15mins	3	+155°C±2°C	30mins	4	Room temp.	10 --- 15mins
	Step	Temperature		Time														
1	-55°C±3°C	30mins																
2	Room temp.	10 --- 15mins																
3	+155°C±2°C	30mins																
4	Room temp.	10 --- 15mins																
±0.5%、±1%	±(0.5%+0.05Ω) Max.																	
Soldering heat	Resistance change rate must be in ±(1%+0.05Ω)		4.18 Dip the resistor into a solder bath having a temperature of 260°C±5°C and hold it for 10±1 seconds.															
Terminal bending	±(1%+0.05Ω) Max		4.33 Twist of test board: Y/x = 5/90 mm for 60Seconds															

Approved	Checked	Prepared	File NO.	Edition	Date	Page
William Zhao	Apple Liu	Wu Yiyun	JLC-01-007	1	2016/3/15	7/11



Characteristic	Limits		Test Method (JIS-C-5201& JIS-C-5202)
Insulation resistance	1,000 MΩ or more		4.6 the measuring voltage shall be, measured with a direct voltage of (100±15)V or a voltage equal to the dielectric withstanding voltage., and apply for 1min
Humidity (steady state)	±2%、±5%	±(3.0%+0.1Ω) Max.	4.24 Temporary resistance change after 240 hours exposure in a humidity test chamber controlled at 40±2°C and 90-95% relative humidity,
	±0.5%、±1%	±(0.5%+0.1Ω) Max.	
Load life in humidity	±2%、±5%	±(1.0%+0.05Ω) Max.	7.9 Resistance change after 1,000 hours (1.5 hours "ON",0.5 hour "OFF") at RCWV in a humidity chamber controlled at 40°C±2°C and 90 to 95% relative humidity.
	±0.5%、±1%	±(0.5%+0.05Ω) Max.	
Load life	±2%、±5%	±(3.0%+0.1Ω) Max.	4.25.1 Permanent resistance change after 1,000 hours operating at RCWV with duty cycle 1.5 hours "ON", 0.5 hour "OFF" at 70°C±2°C ambient.
	±0.5%、±1%	±(1.0%+0.1Ω) Max.	

7.0 Explanation of Part No. System:

The standard Part No. includes 14 digits with the following explanation:

7.1 1st ~4th digits

This is to indicate the Chip Resistor.

Example:LE03、LE05、LE06

7.2 5th~6th digits:

7.2.1 This is to indicate the wattage or power rating. To dieting the size and the numbers,

The following codes are used; and please refer to the following chart for detail:

W=Normal Size; S= Small Size "1"~"G"to denotes "1"~"16"as Hexadecimal:

1/16W~1W:

Wattage	1/16	1/10	1/8	1/4
Normal Size	WG	WA	W8	W4
Small Size	/	SA	S8	S4

7.2.2 For power rating less than or equal to 1 watt, the 5th digit will be the letters W to represent the size required & the 6th digit will be a number or a letter code.

Example: S4=1/4WS

7.3 The 7th digit is to denote the Resistance Tolerance. The following letter code is to be used for indicating the standard Resistance Tolerance.

D=±0.5% G=±2% J=±5% F=±1%

7.4 The 8th to 11th digits is to denote the Resistance Value.

7.4.1 For the standard resistance values of E-24 series in 5%&10% tolerance, the 8th digit is "0",the 9th & 10th digits are to denote the significant figures of the resistance and the 11th digit is the number of

Approved	Checked	Prepared	File NO.	Edition	Date	Page
William Zhao	Apple Liu	Wu Yiyun	JLC-01-007	1	2016/3/15	8/11



ISO14001

ISO/TS16949

244546

245468

REG.-Nr.A759

CQC04001010658

zeros following;

For the standard resistance values of E-96 series in $\leq 2\%$ tolerance, the 8th digit to the 10th digits is to denote the significant figures of the resistance and the 11th digit is the zeros following.

7.4.2 The following number s and the letter codes are to be used to indicate the number of zeros in the 11th digit:

0=10⁰ 1=10¹ 2=10² 3=10³ 4=10⁴ 5=10⁵ 6=10⁶ J=10⁻¹ K=10⁻² L=10⁻³
M=10⁻⁴

7.5 The 12th, 13th & 14th digits.

7.5.1 The 12th digit is to denote the Packaging Type with the following codes:

C=Bulk in (Chip Product) T=Tape/Reel

7.5.2 The 13th digit is normally to indicate the Packing Quantity of Tape/Box & Tape/Reel packaging types. The following letter code is to be used for some packing quantities:

5=5000pcs

7.5.3 For some items, the 14th digit alone can use to denote special features of additional information with the following codes:

"*" = the internal series general character (usually shown with A, B, C etc.).

8.0 Ordering Procedure: (Example: LE06 1/4WS $\pm 5\%$ 150 Ω T/R-5000)

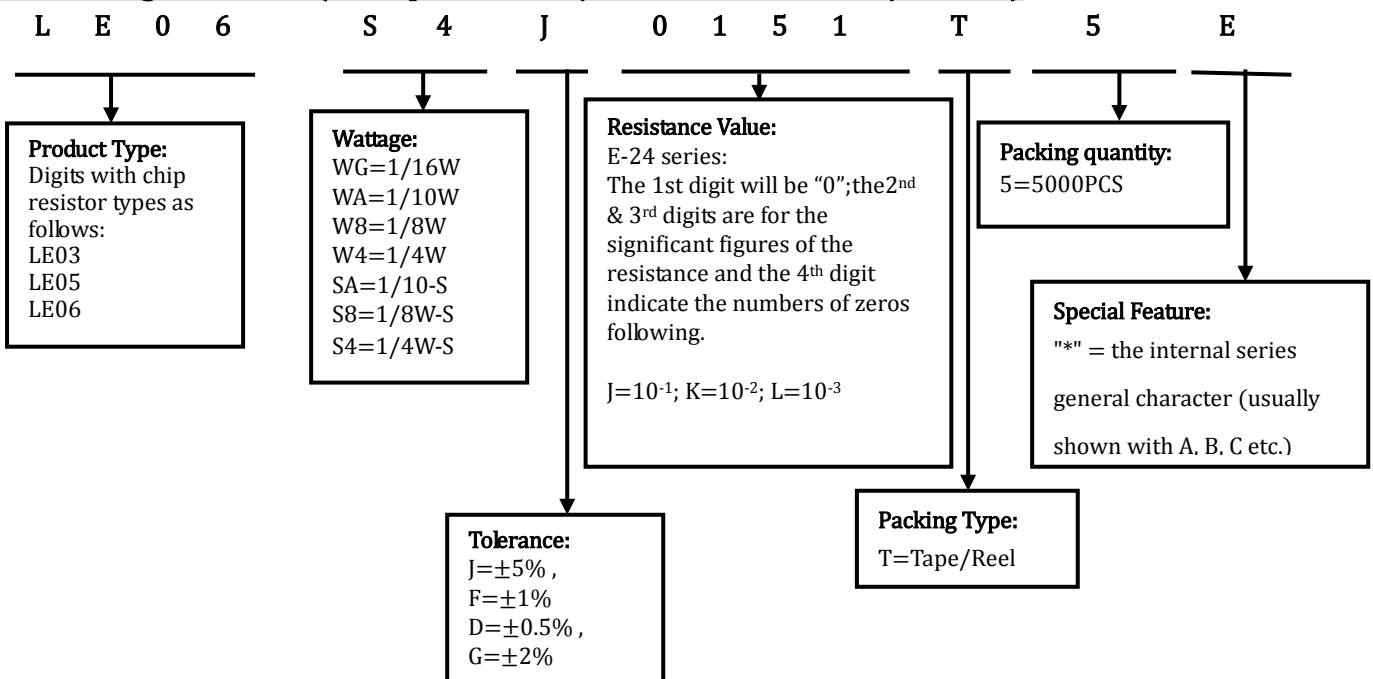

Approved	Checked	Prepared	File NO.	Edition	Date	Page
William Zhao	Apple Liu	Wu Yiyun	JLC-01-007	1	2016/3/15	9/11



ISO14001



ISO/TS16949



244546



245468



REG.-Nr.A759



CQC04001010058

9.0 Packaging:

9.1 Tapping Dimension:

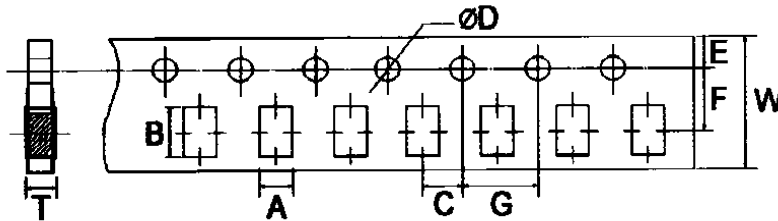

Unit mm

Type	A ±0.2	B ±0.2	C ±0.05	ΦD ±0.1	E ±0.1	F ±0.05	G ±0.1	W ±0.2	T ±0.1
LE03	1.10	1.90	2.00	1.50	1.75	3.50	4.00	8.00	0.67
LE05	1.65	2.40	2.00	1.50	1.75	3.50	4.00	8.00	0.81
LE06	2.00	3.60	2.00	1.50	1.75	3.50	4.00	8.00	0.81

9.2 Dimension:

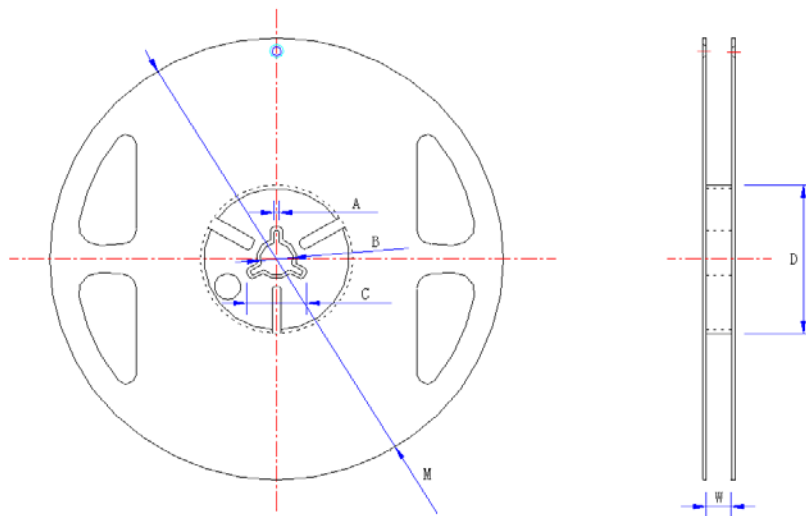

Unit mm

Type	Taping	Qty/Reel	A ±0.5	B ±0.5	C ±0.5	D ±1	M ±2	W ±1
LE03	Paper	5,000pcs	2.0	13.0	21.0	60.0	178	10
LE05	Paper	5,000pcs	2.0	13.0	21.0	60.0	178	10
LE06	Paper	5,000pcs	2.0	13.0	21.0	60.0	178	10

Approved	Checked	Prepared	File NO.	Edition	Date	Page
William Zhao	Apple Liu	Wu Yiyun	JLC-01-007	1	2016/3/15	10/11



10.0 Note :

- 10.1 UNIOHM'S recommend the storage condition as temperature: 15°C~35°C, humidity: 25%~75%.
Even under storage condition above-mentioned, resistors' solderability still degrades day by day.
- 10.2 Store / delivery cartons must be put by correct direction; otherwise product will crack or bent.
- 10.3 Product performance and soldered connections may deteriorate if the products are stored in the following places:
 - 10.3.1 In high electrostatic
 - 10.3.2 Direct sunshine, rain, snow or condensation
 - 10.3.3 Exposed to sea winds or corrosive gases, including Cl₂, H₂S, NH₃, SO₂, and NO₂.

Approved	Checked	Prepared	File NO.	Edition	Date	Page
William Zhao	Apple Liu	Wu Yiyun	JLC-01-007	1	2016/3/15	11/11