

10-MHz LOW-NOISE LOW-VOLTAGE LOW-POWER OPERATIONAL AMPLIFIERS

Check for Samples: [LMV721](#), [LMV722](#)

FEATURES

- Power-Supply Voltage Range: 2.2 V to 5.5 V
- Low Supply Current: 930 μ A/Amplifier at 2.2 V
- High Unity-Gain Bandwidth: 10 MHz
- Rail-to-Rail Output Swing
 - 600- Ω Load: 120 mV From Either Rail at 2.2 V
 - 2-k Ω Load: 50 mV From Either Rail at 2.2 V
- Input Common-Mode Voltage Range Includes Ground
- Input Voltage Noise: 9 nV/ $\sqrt{\text{Hz}}$ at f = 1 kHz

APPLICATIONS

- Cellular and Cordless Phones
- Active Filter and Buffers
- Laptops and PDAs
- Battery Powered Electronics

DESCRIPTION/ORDERING INFORMATION

The LMV721 (single) and LMV722 (dual) are low-noise low-voltage low-power operational amplifiers that can be designed into a wide range of applications. The LMV721 and LMV722 have a unity-gain bandwidth of 10 MHz, a slew rate of 5 V/ μ s, and a quiescent current of 930 μ A/amplifier at 2.2 V.

The LMV721 and LMV722 are designed to provide optimal performance in low-voltage and low-noise systems. They provide rail-to-rail output swing into heavy loads. The input common-mode voltage range includes ground, and the maximum input offset voltage are 3.5 mV (over recommended temperature range) for the devices. Their capacitive load capability is also good at low supply voltages. The operating range is from 2.2 V to 5.5 V.

ORDERING INFORMATION⁽¹⁾

T _A	PACKAGE ⁽²⁾		ORDERABLE PART NUMBER	TOP-SIDE MARKING ⁽³⁾	
–40°C to 105°C	Single	SC-70 – DCK	Reel of 3000	LMV721DCKR	RK_
			Reel of 250	LMV721DCKT	
		SOT-23 – DBV	Reel of 3000	LMV721DBVR	RBF_
	Dual	SOIC – D	Reel of 2500	LMV722IDR	MV722I
			Tube of 75	LMV722ID	
		VSSOP – DGK	Reel of 2500	LMV722IDGKR	R6_
QFN – DRG	Reel of 2500	LMV722IDRGR	ZYY		

- (1) For the most current package and ordering information, see the Package Option Addendum at the end of this document, or see the TI web site at www.ti.com.
- (2) Package drawings, thermal data, and symbolization are available at www.ti.com/packaging.
- (3) DBV/DCK/DGK: The actual top-side marking has one additional character that designates the wafer fab/assembly site.



Please be aware that an important notice concerning availability, standard warranty, and use in critical applications of Texas Instruments semiconductor products and disclaimers thereto appears at the end of this data sheet.

Typical Application

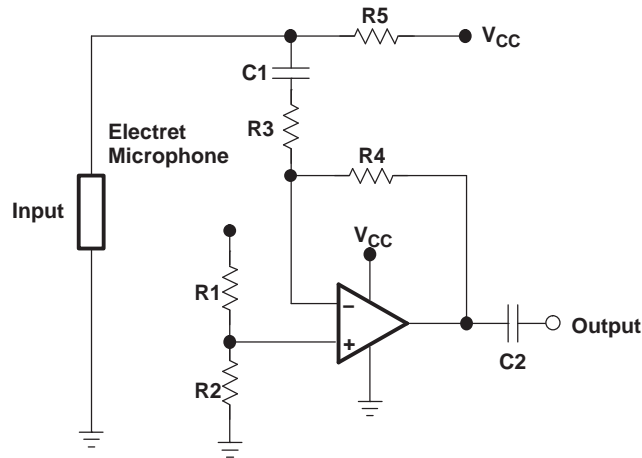

Absolute Maximum Ratings⁽¹⁾

over operating free-air temperature range (unless otherwise noted)

		MIN	MAX	UNIT
$V_{CC+} - V_{CC-}$	Supply voltage ⁽²⁾		6	V
V_{ID}	Differential input voltage ⁽³⁾	±Supply voltage		V
θ_{JA}	Package thermal impedance ⁽⁴⁾	D package ⁽⁵⁾		°C/W
		DBV package ⁽⁵⁾		
		DCK package ⁽⁵⁾		
		DGK package ⁽⁵⁾		
		DRG package ⁽⁶⁾		
T_J	Operating virtual-junction temperature		150	°C
T_{stg}	Storage temperature range	-65	150	°C

- (1) Stresses beyond those listed under *absolute maximum ratings* may cause permanent damage to the device. These are stress ratings only, and functional operation of the device at these or any other conditions beyond those indicated under *recommended operating conditions* is not implied. Exposure to absolute-maximum-rated conditions for extended periods may affect device reliability.
- (2) All voltage values (except differential voltages and V_{CC} specified for the measurement of I_{OS}) are with respect to the network GND.
- (3) Differential voltages are at IN+ with respect to IN-.
- (4) Maximum power dissipation is a function of $T_J(\max)$, θ_{JA} , and T_A . The maximum allowable power dissipation at any allowable ambient temperature is $P_D = (T_J(\max) - T_A)/\theta_{JA}$. Operating at the absolute maximum T_J of 150°C can affect reliability.
- (5) The package thermal impedance is calculated in accordance with JESD 51-7.
- (6) The package thermal impedance is calculated in accordance with JESD 51-5.

Recommended Operating Conditions

		MIN	MAX	UNIT
$V_{CC+} - V_{CC-}$	Supply voltage	2.2	5.5	V
T_J	Operating virtual-junction temperature	-40	105	°C

ESD Protection

	TYP	UNIT
Human-Body Model	2000	V
Machine Model	100	V

Electrical Characteristics

 $V_{CC+} = 2.2\text{ V}$, $V_{CC-} = \text{GND}$, $V_{ICR} = V_{CC+}/2$, $V_O = V_{CC+}/2$, and $R_L > 1\text{ M}\Omega$ (unless otherwise noted)

PARAMETER		TEST CONDITIONS	T_J	MIN	TYP	MAX	UNIT
V_{IO}	Input offset voltage		25°C		0.02	3	mV
			–40°C to 105°C			3.5	
TCV_{IO}	Input offset voltage average drift		25°C		0.6		$\mu\text{V}/^\circ\text{C}$
I_{IB}	Input bias current		25°C		260		nA
I_{IO}	Input offset current		25°C		25		nA
CMMR	Common-mode rejection ratio	$V_{ICR} = 0\text{ V to }1.3\text{ V}$	25°C	70	88		dB
			–40°C to 105°C	64			
PSRR	Power-supply rejection ratio	$V_{CC+} = 2.2\text{ V to }5\text{ V}$, $V_O = 0$, $V_{ICR} = 0$	25°C	80	90		dB
			–40°C to 105°C	70			
V_{ICR}	Input common-mode voltage	CMRR $\geq 50\text{ dB}$	25°C		–0.3		V
					1.3		
A_{VD}	Large-signal voltage gain	$R_L = 600\ \Omega$, $V_O = 0.75\text{ V to }2\text{ V}$	25°C	75	81		dB
			–40°C to 105°C	70			
		$R_L = 2\text{ k}\Omega$, $V_O = 0.5\text{ V to }2.1\text{ V}$	25°C	75	84		
			–40°C to 105°C	70			
V_O	Output swing	$R_L = 600\ \Omega\text{ to }V_{CC+}/2$	25°C	2.090	2.125		V
			–40°C to 105°C	2.065			
			25°C		0.071	0.120	
			–40°C to 105°C			0.145	
		$R_L = 2\text{ k}\Omega\text{ to }V_{CC+}/2$	25°C	2.150	2.177		
			–40°C to 105°C	2.125			
			25°C		0.056	0.080	
			–40°C to 105°C			0.105	
I_O	Output current	Sourcing, $V_O = 0\text{ V}$, $V_{IN(\text{diff})} = \pm 0.5\text{ V}$	25°C	10	14.9		mA
			–40°C to 105°C	5			
		Sinking, $V_O = 2.2\text{ V}$, $V_{IN(\text{diff})} = \pm 0.5\text{ V}$	25°C	10	17.6		
			–40°C to 105°C	5			
I_{CC}	Supply current	LMV721	25°C		0.93	1.3	mA
			–40°C to 105°C			1.5	
		LMV722	25°C		1.81	2.4	
			–40°C to 105°C			2.6	
SR	Slew rate ⁽¹⁾		25°C		4.9		V/ μs
GBW	Gain bandwidth product		25°C		10		MHz
Φ_m	Phase margin		25°C		67.4		°
G_m	Gain margin		25°C		–9.8		dB
V_n	Input-referred voltage noise	$f = 1\text{ kHz}$	25°C		9		$\text{nV}/\sqrt{\text{Hz}}$
I_n	Input-referred current noise	$f = 1\text{ kHz}$	25°C		0.3		$\text{pA}/\sqrt{\text{Hz}}$
THD	Total harmonic distortion	$f = 1\text{ kHz}$, $A_V = 1$, $R_L = 600\ \Omega$, $V_O = 500\text{ mV}_{pp}$	25°C		0.004		%

(1) Connected as voltage follower with 1-V step input. Number specified is the slower of the positive and negative slew rate.

Electrical Characteristics

$V_{CC+} = 5\text{ V}$, $V_{CC-} = \text{GND}$, $V_{ICR} = V_{CC+}/2$, $V_O = V_{CC+}/2$, and $R_L > 1\text{ M}\Omega$ (unless otherwise noted)

PARAMETER		TEST CONDITIONS	T_J	MIN	TYP	MAX	UNIT
V_{IO}	Input offset voltage		25°C	-0.08	3		mV
			-40°C to 105°C		3.5		
TCV_{IO}	Input offset voltage average drift		25°C	0.6			$\mu\text{V}/^\circ\text{C}$
I_{IB}	Input bias current		25°C	260			nA
I_{IO}	Input offset current		25°C	25			nA
CMMR	Common-mode rejection ratio	$V_{ICR} = 0\text{ V to } 4.1\text{ V}$	25°C	80	89		dB
			-40°C to 105°C	75			
PSRR	Power-supply rejection ratio	$V_{CC+} = 2.2\text{ V to } 5\text{ V}$, $V_O = 0$, $V_{ICR} = 0$	25°C	70	90		dB
			-40°C to 105°C	64			
V_{ICR}	Input common-mode voltage	CMRR $\geq 50\text{ dB}$	25°C	-0.3			V
				4.1			
A_{VD}	Large-signal voltage gain	$R_L = 600\ \Omega$, $V_O = 0.75\text{ V to } 4.8\text{ V}$	25°C	80	87		dB
			-40°C to 105°C	70			
		$R_L = 2\text{ k}\Omega$, $V_O = 0.7\text{ V to } 4.9\text{ V}$	25°C	80	94		
			-40°C to 105°C	70			
V_O	Output swing	$R_L = 600\ \Omega\text{ to } V_{CC+}/2$	25°C	4.84	4.882		V
			-40°C to 105°C	4.815			
			25°C	0.134	0.19		
			-40°C to 105°C	0.215			
		$R_L = 2\text{ k}\Omega\text{ to } V_{CC+}/2$	25°C	4.93	4.952		
			-40°C to 105°C	4.905			
			25°C	0.076	0.11		
			-40°C to 105°C	0.135			
I_O	Output current	Sourcing, $V_O = 0\text{ V}$, $V_{IN(\text{diff})} = \pm 0.5\text{ V}$	25°C	20	52.6		mA
			-40°C to 105°C	12			
		Sinking, $V_O = 2.2\text{ V}$, $V_{IN(\text{diff})} = \pm 0.5\text{ V}$	25°C	15	23.7		
			-40°C to 105°C	8.5			
I_{CC}	Supply current	LMV721	25°C	1.03	1.4		mA
			-40°C to 105°C		1.7		
		LMV722	25°C	2.01	2.4		
			-40°C to 105°C		2.8		
SR	Slew rate ⁽¹⁾		25°C	5.25			$\text{V}/\mu\text{s}$
GBW	Gain bandwidth product		25°C	10			MHz
Φ_m	Phase margin		25°C	72			°
G_m	Gain margin		25°C	-11			dB
V_n	Input-referred voltage noise	$f = 1\text{ kHz}$	25°C	8.5			$\text{nV}/\sqrt{\text{Hz}}$
I_n	Input-referred current noise	$f = 1\text{ kHz}$	25°C	0.2			$\text{pA}/\sqrt{\text{Hz}}$
THD	Total harmonic distortion	$f = 1\text{ kHz}$, $AV = 1$, $R_L = 600\ \Omega$, $V_O = 500\text{ mV}_{pp}$	25°C	0.001			%

(1) Connected as voltage follower with 1-V step input. Number specified is the slower of the positive and negative slew rate.

TYPICAL CHARACTERISTICS

SUPPLY CURRENT
vs
SUPPLY VOLTAGE

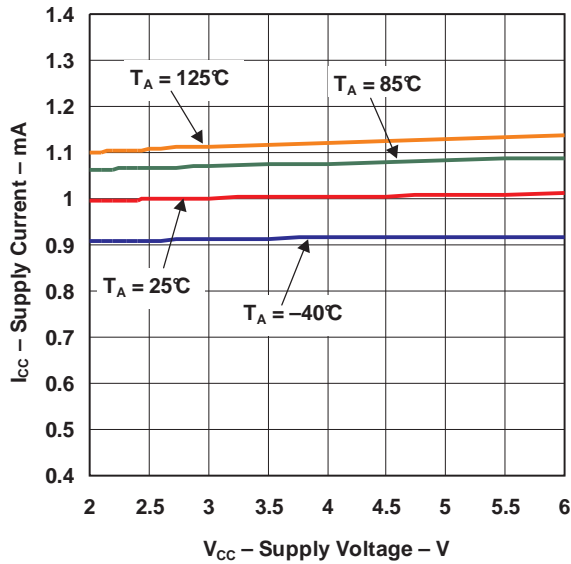

SOURCING CURRENT
vs
OUTPUT VOLTAGE

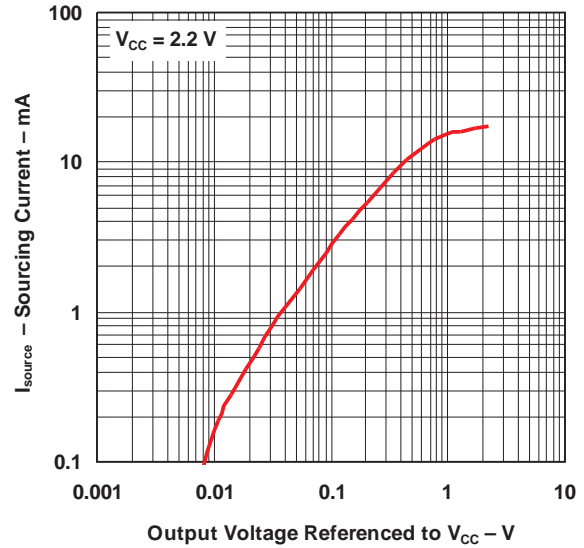

SOURCING CURRENT
vs
OUTPUT VOLTAGE

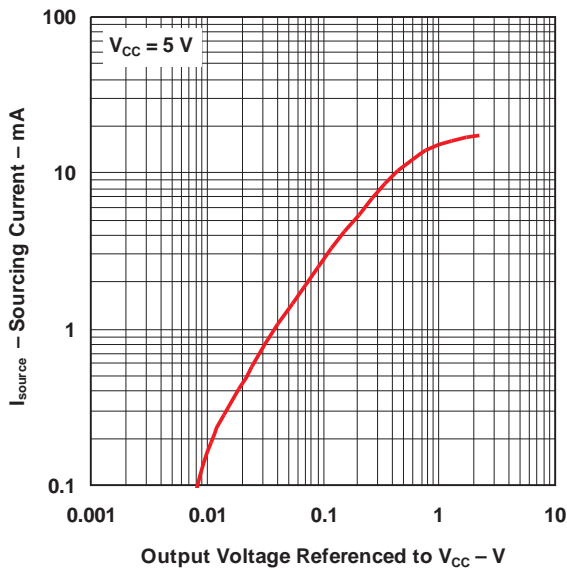

SINKING CURRENT
vs
OUTPUT VOLTAGE

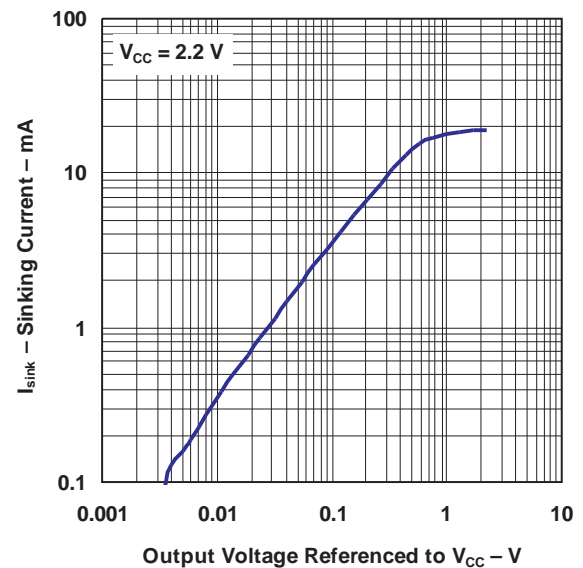

TYPICAL CHARACTERISTICS (continued)

**SINKING CURRENT
vs
OUTPUT VOLTAGE**

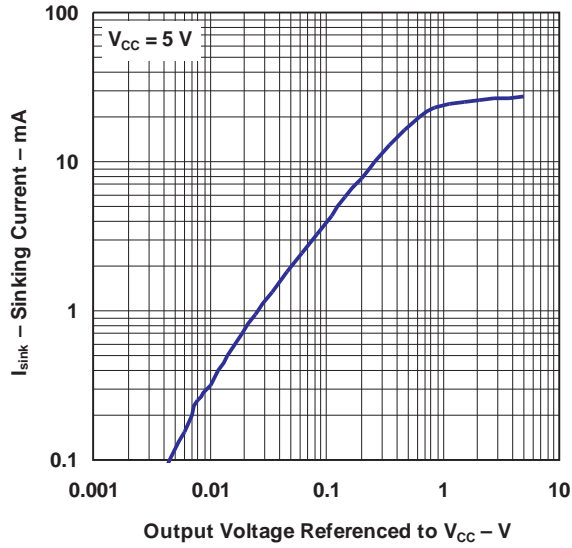

**OUTPUT VOLTAGE SWING
vs
SUPPLY VOLTAGE**

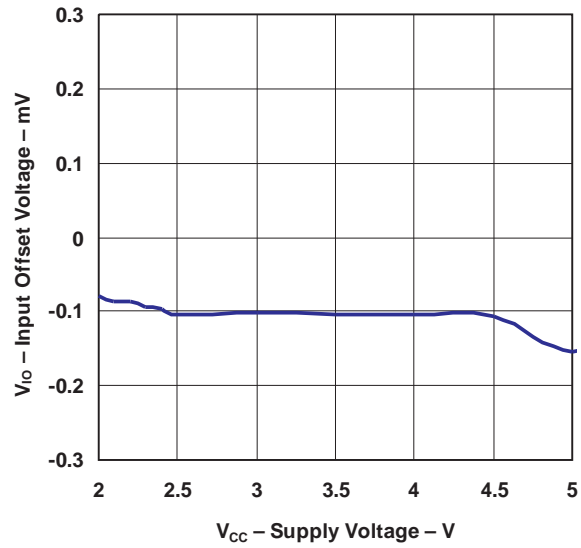

**INPUT OFFSET VOLTAGE
vs
INPUT COMMON-MODE VOLTAGE**

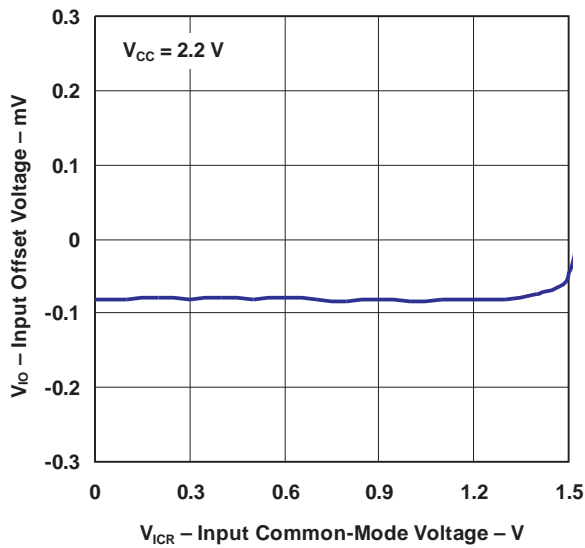

**INPUT OFFSET VOLTAGE
vs
INPUT COMMON-MODE VOLTAGE**

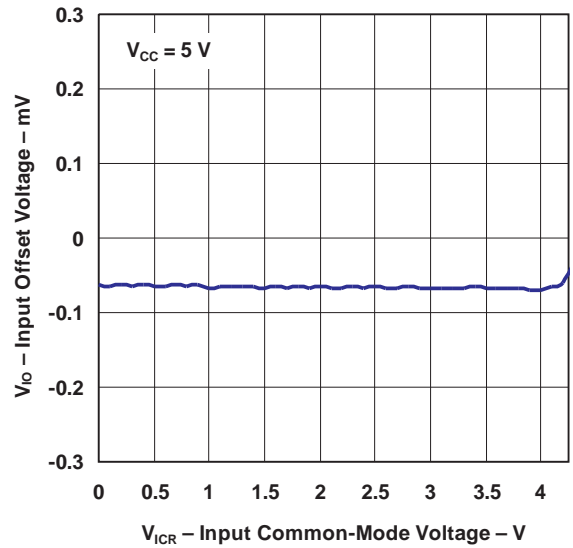

TYPICAL CHARACTERISTICS (continued)

INPUT VOLTAGE
vs
OUTPUT VOLTAGE

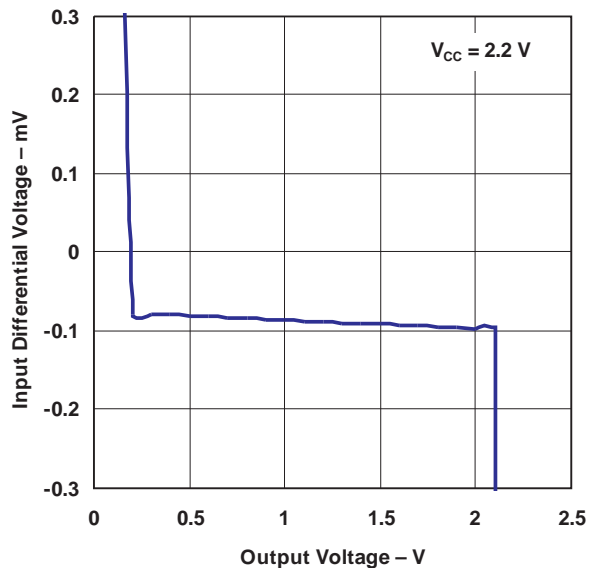

INPUT VOLTAGE
vs
OUTPUT VOLTAGE

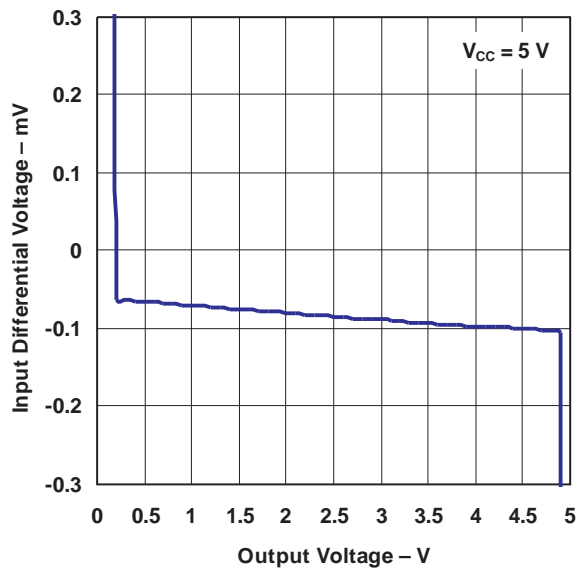

INPUT VOLTAGE NOISE
vs
FREQUENCY

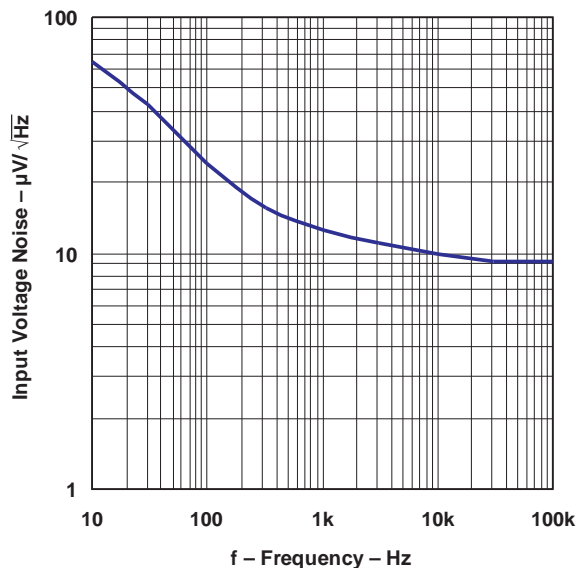

INPUT CURRENT NOISE
vs
FREQUENCY

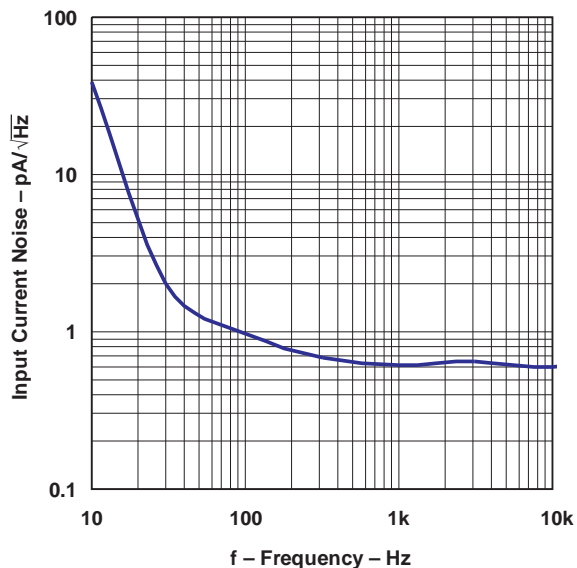

TYPICAL CHARACTERISTICS (continued)

PSRR
vs
FREQUENCY

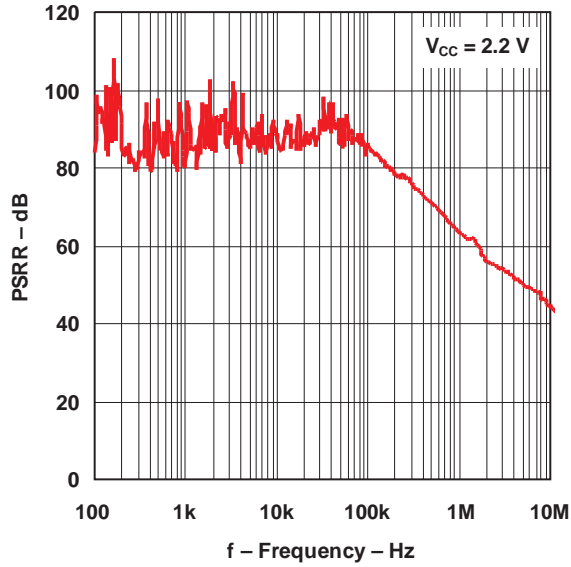

PSRR
vs
FREQUENCY

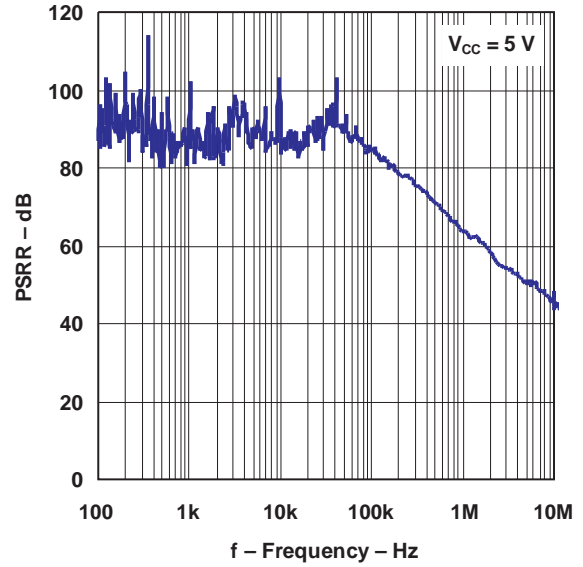

GAIN AND PHASE
vs
FREQUENCY

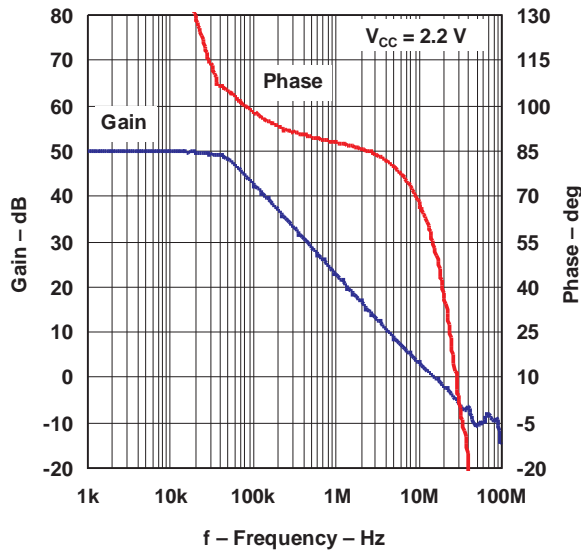

GAIN AND PHASE
vs
FREQUENCY

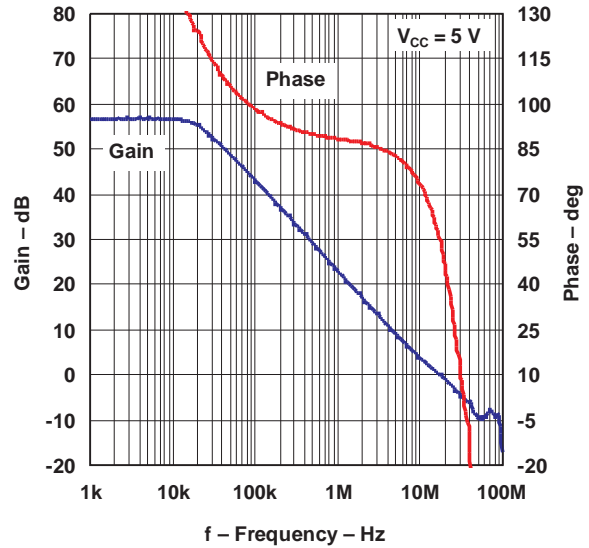

TYPICAL CHARACTERISTICS (continued)

SLEW RATE
vs
SUPPLY VOLTAGE

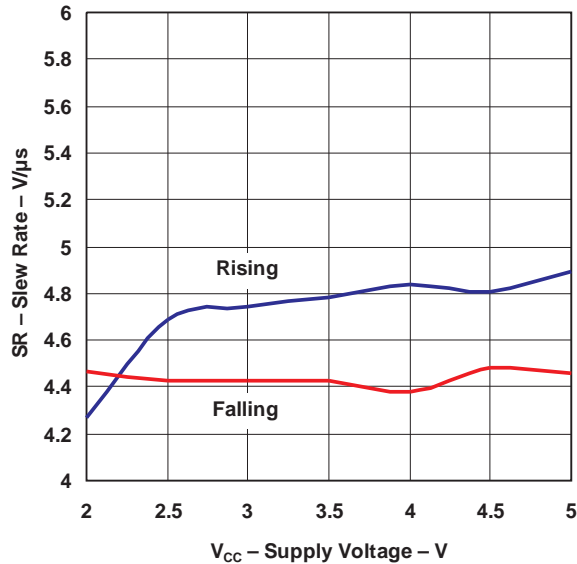

THD
vs
FREQUENCY

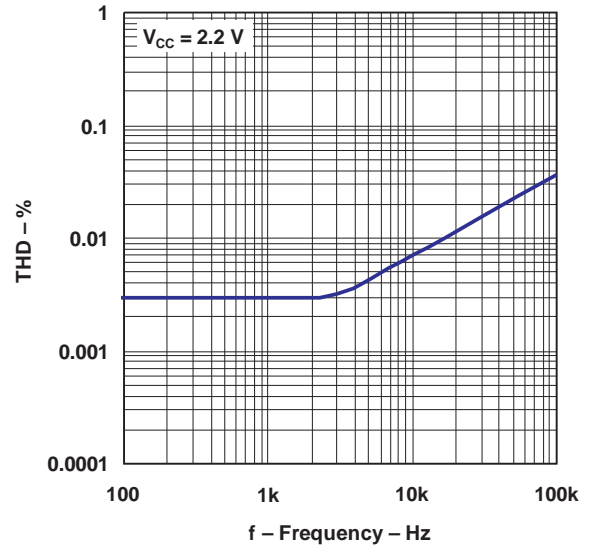

PULSE RESPONSE

V_{CC} = 5 V, R_L = 2 kΩ, C_L = 21.2 nF, R_O = 0 Ω

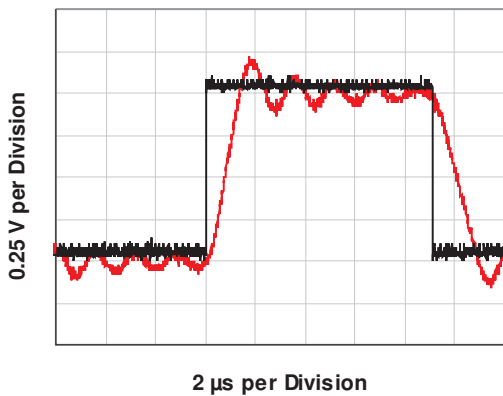

PULSE RESPONSE

V_{CC} = 5 V, R_L = 2 kΩ, C_L = 21.2 nF, R_O = 2.1 Ω

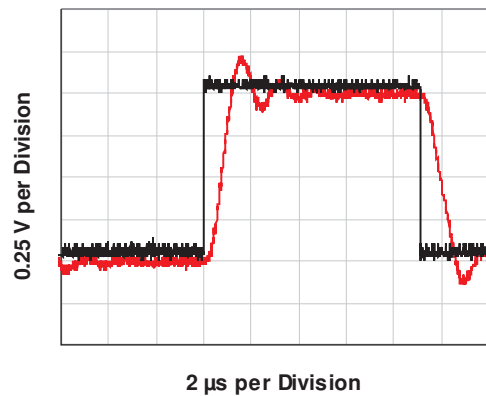

TYPICAL CHARACTERISTICS (continued)

PULSE RESPONSE

$V_{cc} = 5\text{ V}, R_L = 2\text{ k}\Omega, C_L = 21.2\text{ nF}, R_o = 9.5\ \Omega$

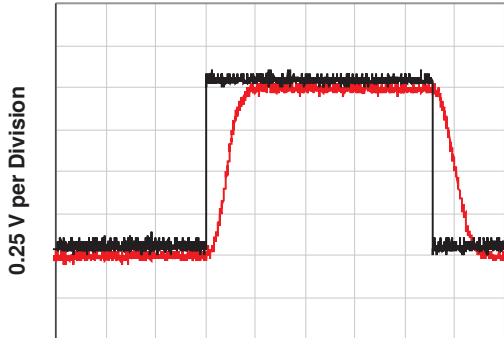

2 μs per Division

PULSE RESPONSE

$V_{cc} = 5\text{ V}, R_L = 10\text{ k}\Omega, C_L = 21.2\text{ nF}, R_o = 0\ \Omega$

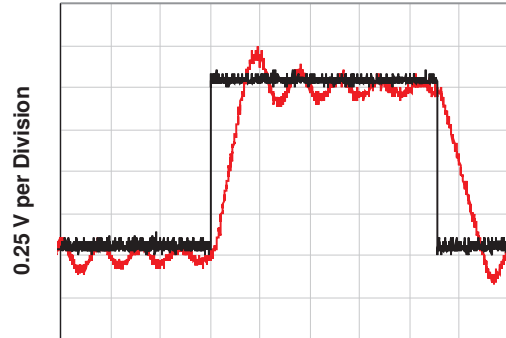

2 μs per Division

PULSE RESPONSE

$V_{cc} = 5\text{ V}, R_L = 600\ \Omega, C_L = 21.2\text{ nF}, R_o = 0\ \Omega$

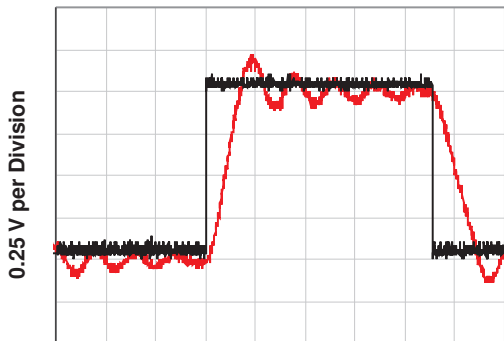

2 μs per Division

PULSE RESPONSE

$V_{cc} = 2.2\text{ V}, R_L = 2\ \Omega, C_L = 2.12\text{ nF}, R_o = 0\ \Omega$

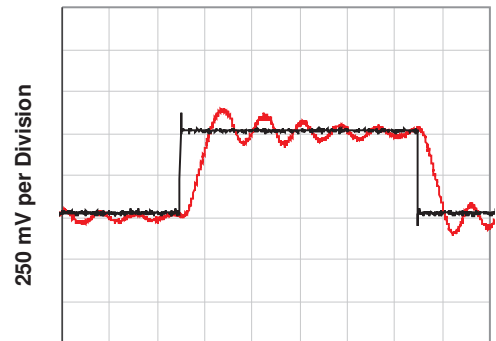

1 μs per Division

PULSE RESPONSE

$V_{cc} = 2.2\text{ V}, R_L = 2\text{ k}\Omega, C_L = 2.12\text{ nF}, R_o = 0\ \Omega$

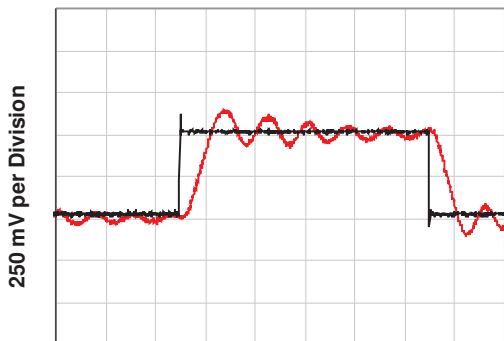

1 μs per Division

PULSE RESPONSE

$V_{cc} = 2.2\text{ V}, R_L = 10\text{ k}\Omega, C_L = 2.12\text{ nF}, R_o = 0\ \Omega$

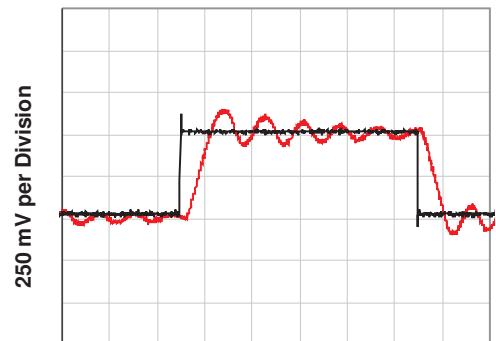

1 μs per Division

TYPICAL CHARACTERISTICS (continued)

PULSE RESPONSE

$V_{cc} = 2.2\text{ V}$, $R_L = 10\text{ k}\Omega$, $C_L = 2.12\text{ nF}$, $R_o = 2.2\ \Omega$

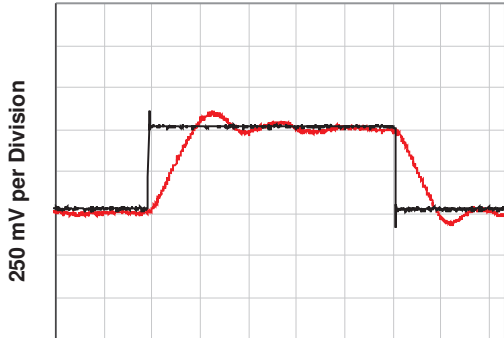

1 μs per Division

PULSE RESPONSE

$V_{cc} = 2.2\text{ V}$, $R_L = 10\text{ k}\Omega$, $C_L = 2.12\text{ nF}$, $R_o = 11.5\ \Omega$

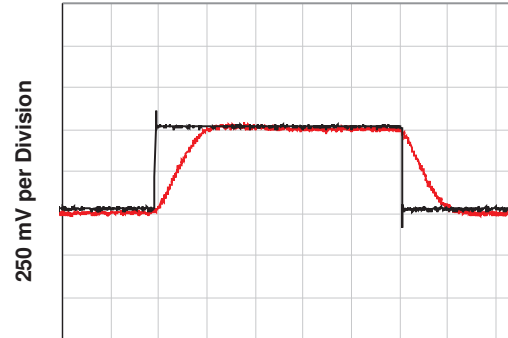

1 μs per Division

PULSE RESPONSE

$V_{cc} = 2.2\text{ V}$, $R_L = 600\ \Omega$, $C_L = 1.89\text{ nF}$, $R_o = 0\ \Omega$

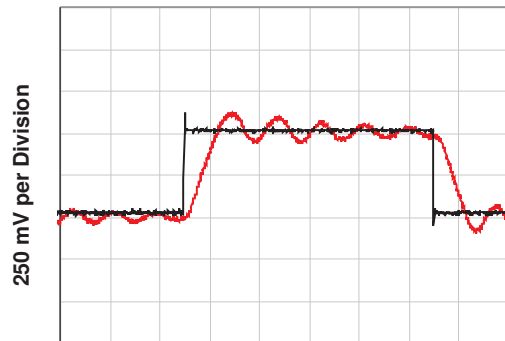

1 μs per Division

REVISION HISTORY

Changes from Revision B (August 2010) to Revision C	Page
• Changed all temperature parameters from max of 85°C to 105°C	1
• Changed supply voltage max value to 6 in Absolute Maximum Ratings table	2
• Changed supply voltage MAX value to 5.5 in Recommended Operating Conditions table	2
• Changed A_{VD} , V_O test conditons for $R_L = 600 \Omega$: 0.75 V to 4.8 V	4
• Changed A_{VD} , V_O test conditons for $R_L = 2 \text{ k}\Omega$: 0.75 V to 4.8 V	4

PACKAGING INFORMATION

Orderable Device	Status (1)	Package Type	Package Drawing	Pins	Package Qty	Eco Plan (2)	Lead/Ball Finish (6)	MSL Peak Temp (3)	Op Temp (°C)	Device Marking (4/5)	Samples
LMV721IDBVR	ACTIVE	SOT-23	DBV	5	3000	Green (RoHS & no Sb/Br)	CU NIPDAU	Level-1-260C-UNLIM	-40 to 105	(RBFA ~ RBFM)	Samples
LMV721IDCKR	ACTIVE	SC70	DCK	5	3000	Green (RoHS & no Sb/Br)	CU NIPDAU CU NIPDAUAG	Level-1-260C-UNLIM	-40 to 105	(RKA ~ RKM)	Samples
LMV721IDCKT	ACTIVE	SC70	DCK	5	250	Green (RoHS & no Sb/Br)	CU NIPDAU CU NIPDAUAG	Level-1-260C-UNLIM	-40 to 105	(RKA ~ RKM)	Samples
LMV722ID	ACTIVE	SOIC	D	8	75	Green (RoHS & no Sb/Br)	CU NIPDAU	Level-1-260C-UNLIM	-40 to 105	MV722I	Samples
LMV722IDG4	ACTIVE	SOIC	D	8	75	Green (RoHS & no Sb/Br)	CU NIPDAU	Level-1-260C-UNLIM	-40 to 105	MV722I	Samples
LMV722IDGKR	ACTIVE	VSSOP	DGK	8	2500	Green (RoHS & no Sb/Br)	CU NIPDAU	Level-1-260C-UNLIM	-40 to 105	R6E	Samples
LMV722IDGKRG4	ACTIVE	VSSOP	DGK	8	2500	Green (RoHS & no Sb/Br)	CU NIPDAU	Level-1-260C-UNLIM	-40 to 105	R6E	Samples
LMV722IDR	ACTIVE	SOIC	D	8	2500	Green (RoHS & no Sb/Br)	CU NIPDAU	Level-1-260C-UNLIM	-40 to 105	MV722I	Samples
LMV722IDRG4	ACTIVE	SOIC	D	8	2500	Green (RoHS & no Sb/Br)	CU NIPDAU	Level-1-260C-UNLIM	-40 to 105	MV722I	Samples

(1) The marketing status values are defined as follows:

ACTIVE: Product device recommended for new designs.

LIFEBUY: TI has announced that the device will be discontinued, and a lifetime-buy period is in effect.

NRND: Not recommended for new designs. Device is in production to support existing customers, but TI does not recommend using this part in a new design.

PREVIEW: Device has been announced but is not in production. Samples may or may not be available.

OBSOLETE: TI has discontinued the production of the device.

(2) Eco Plan - The planned eco-friendly classification: Pb-Free (RoHS), Pb-Free (RoHS Exempt), or Green (RoHS & no Sb/Br) - please check <http://www.ti.com/productcontent> for the latest availability information and additional product content details.

TBD: The Pb-Free/Green conversion plan has not been defined.

Pb-Free (RoHS): TI's terms "Lead-Free" or "Pb-Free" mean semiconductor products that are compatible with the current RoHS requirements for all 6 substances, including the requirement that lead not exceed 0.1% by weight in homogeneous materials. Where designed to be soldered at high temperatures, TI Pb-Free products are suitable for use in specified lead-free processes.

Pb-Free (RoHS Exempt): This component has a RoHS exemption for either 1) lead-based flip-chip solder bumps used between the die and package, or 2) lead-based die adhesive used between the die and leadframe. The component is otherwise considered Pb-Free (RoHS compatible) as defined above.

Green (RoHS & no Sb/Br): TI defines "Green" to mean Pb-Free (RoHS compatible), and free of Bromine (Br) and Antimony (Sb) based flame retardants (Br or Sb do not exceed 0.1% by weight in homogeneous material)

- (3) MSL, Peak Temp. - The Moisture Sensitivity Level rating according to the JEDEC industry standard classifications, and peak solder temperature.
- (4) There may be additional marking, which relates to the logo, the lot trace code information, or the environmental category on the device.
- (5) Multiple Device Markings will be inside parentheses. Only one Device Marking contained in parentheses and separated by a "~" will appear on a device. If a line is indented then it is a continuation of the previous line and the two combined represent the entire Device Marking for that device.
- (6) Lead/Ball Finish - Orderable Devices may have multiple material finish options. Finish options are separated by a vertical ruled line. Lead/Ball Finish values may wrap to two lines if the finish value exceeds the maximum column width.

Important Information and Disclaimer:The information provided on this page represents TI's knowledge and belief as of the date that it is provided. TI bases its knowledge and belief on information provided by third parties, and makes no representation or warranty as to the accuracy of such information. Efforts are underway to better integrate information from third parties. TI has taken and continues to take reasonable steps to provide representative and accurate information but may not have conducted destructive testing or chemical analysis on incoming materials and chemicals. TI and TI suppliers consider certain information to be proprietary, and thus CAS numbers and other limited information may not be available for release.

In no event shall TI's liability arising out of such information exceed the total purchase price of the TI part(s) at issue in this document sold by TI to Customer on an annual basis.

TAPE AND REEL INFORMATION

QUADRANT ASSIGNMENTS FOR PIN 1 ORIENTATION IN TAPE

*All dimensions are nominal

Device	Package Type	Package Drawing	Pins	SPQ	Reel Diameter (mm)	Reel Width W1 (mm)	A0 (mm)	B0 (mm)	K0 (mm)	P1 (mm)	W (mm)	Pin1 Quadrant
LMV721IDBVR	SOT-23	DBV	5	3000	178.0	9.0	3.23	3.17	1.37	4.0	8.0	Q3
LMV721IDCKR	SC70	DCK	5	3000	178.0	9.0	2.4	2.5	1.2	4.0	8.0	Q3
LMV721IDCKR	SC70	DCK	5	3000	180.0	8.4	2.47	2.3	1.25	4.0	8.0	Q3
LMV721IDCKT	SC70	DCK	5	250	178.0	9.0	2.4	2.5	1.2	4.0	8.0	Q3
LMV721IDCKT	SC70	DCK	5	250	180.0	8.4	2.47	2.3	1.25	4.0	8.0	Q3
LMV722IDGKR	VSSOP	DGK	8	2500	330.0	12.4	5.3	3.3	1.3	8.0	12.0	Q1
LMV722IDR	SOIC	D	8	2500	330.0	12.4	6.4	5.2	2.1	8.0	12.0	Q1

TAPE AND REEL BOX DIMENSIONS

*All dimensions are nominal

Device	Package Type	Package Drawing	Pins	SPQ	Length (mm)	Width (mm)	Height (mm)
LMV721IDBVR	SOT-23	DBV	5	3000	180.0	180.0	18.0
LMV721IDCKR	SC70	DCK	5	3000	180.0	180.0	18.0
LMV721IDCKR	SC70	DCK	5	3000	202.0	201.0	28.0
LMV721IDCKT	SC70	DCK	5	250	180.0	180.0	18.0
LMV721IDCKT	SC70	DCK	5	250	202.0	201.0	28.0
LMV722IDGKR	VSSOP	DGK	8	2500	346.0	346.0	35.0
LMV722IDR	SOIC	D	8	2500	340.5	338.1	20.6

DBV (R-PDSO-G5)

PLASTIC SMALL-OUTLINE PACKAGE

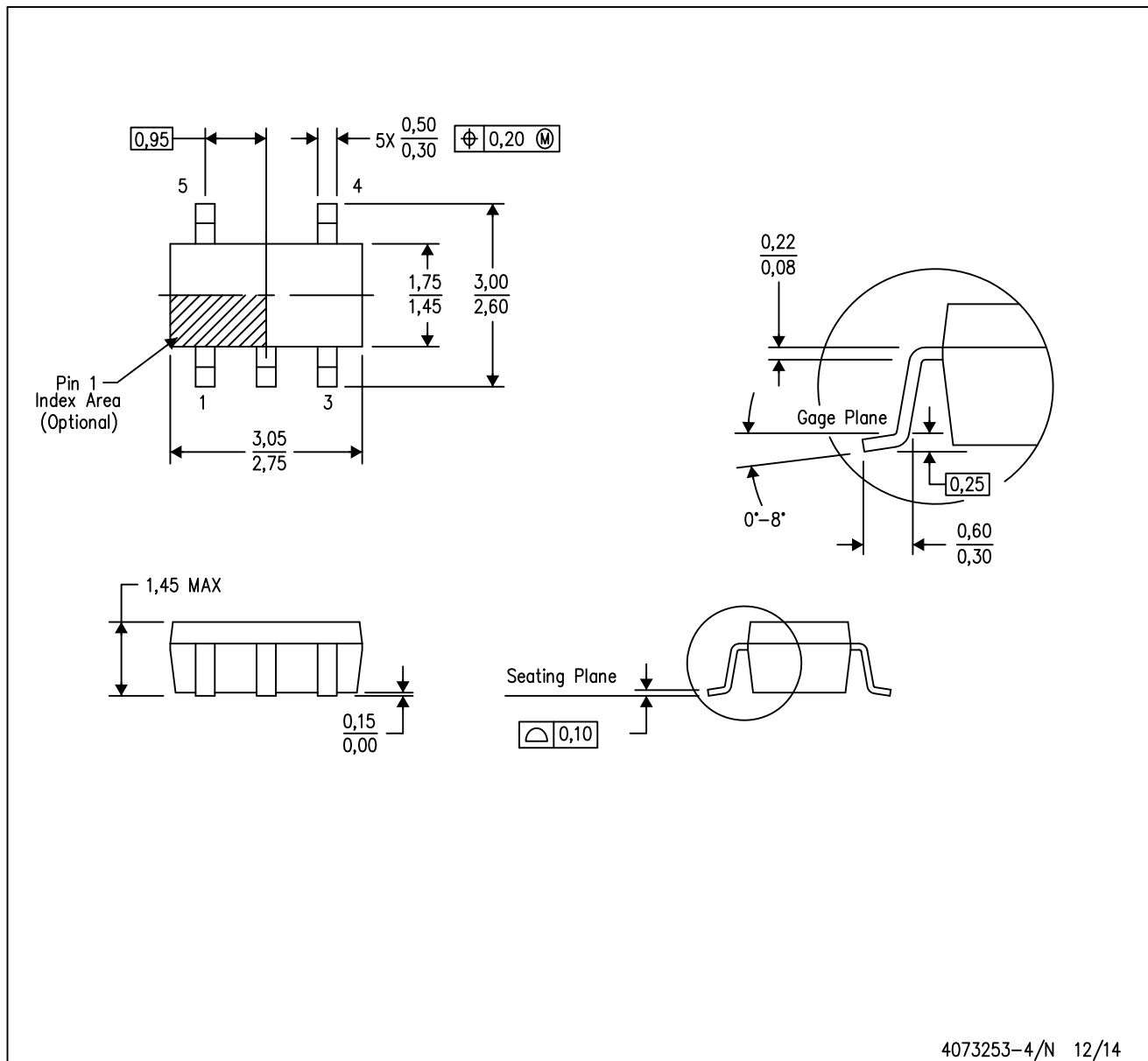

- NOTES:
- A. All linear dimensions are in millimeters.
 - B. This drawing is subject to change without notice.
 - C. Body dimensions do not include mold flash or protrusion. Mold flash and protrusion shall not exceed 0.15 per side.
 - D. Falls within JEDEC MO-178 Variation AA.

DBV (R-PDSO-G5)

PLASTIC SMALL OUTLINE



- NOTES:
- A. All linear dimensions are in millimeters.
 - B. This drawing is subject to change without notice.
 - C. Customers should place a note on the circuit board fabrication drawing not to alter the center solder mask defined pad.
 - D. Publication IPC-7351 is recommended for alternate designs.
 - E. Laser cutting apertures with trapezoidal walls and also rounding corners will offer better paste release. Customers should contact their board assembly site for stencil design recommendations. Example stencil design based on a 50% volumetric metal load solder paste. Refer to IPC-7525 for other stencil recommendations.

DCK (R-PDSO-G5)

PLASTIC SMALL-OUTLINE PACKAGE



- NOTES:
- A. All linear dimensions are in millimeters.
 - B. This drawing is subject to change without notice.
 - C. Body dimensions do not include mold flash or protrusion. Mold flash and protrusion shall not exceed 0.15 per side.
 - D. Falls within JEDEC MO-203 variation AA.

DCK (R-PDSO-G5)

PLASTIC SMALL OUTLINE

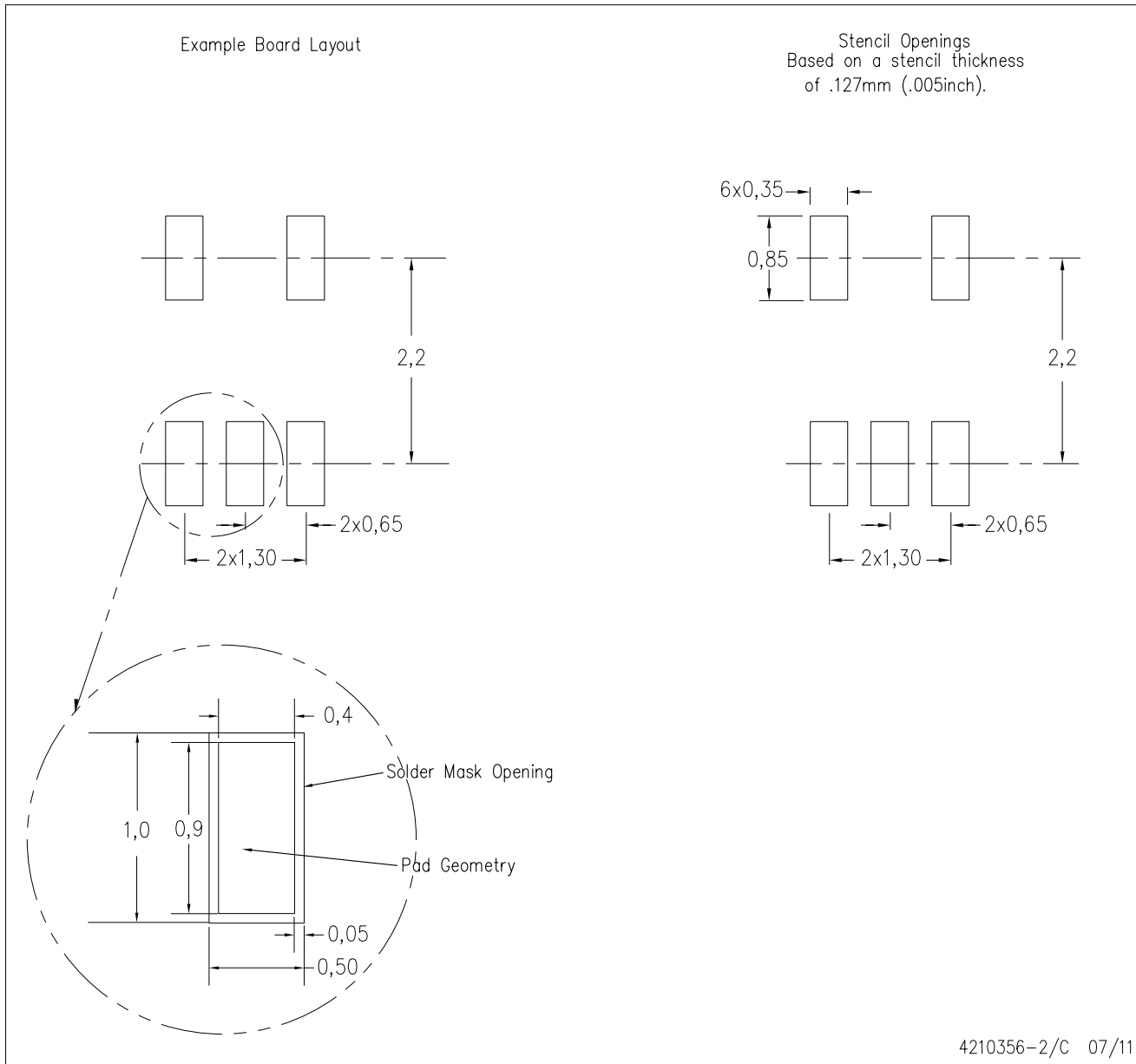

- NOTES:
- All linear dimensions are in millimeters.
 - This drawing is subject to change without notice.
 - Customers should place a note on the circuit board fabrication drawing not to alter the center solder mask defined pad.
 - Publication IPC-7351 is recommended for alternate designs.
 - Laser cutting apertures with trapezoidal walls and also rounding corners will offer better paste release. Customers should contact their board assembly site for stencil design recommendations. Example stencil design based on a 50% volumetric metal load solder paste. Refer to IPC-7525 for other stencil recommendations.

DGK (S-PDSO-G8)

PLASTIC SMALL-OUTLINE PACKAGE



- NOTES:
- A. All linear dimensions are in millimeters.
 - B. This drawing is subject to change without notice.
 - C. Body length does not include mold flash, protrusions, or gate burrs. Mold flash, protrusions, or gate burrs shall not exceed 0.15 per end.
 - D. Body width does not include interlead flash. Interlead flash shall not exceed 0.50 per side.
 - E. Falls within JEDEC MO-187 variation AA, except interlead flash.

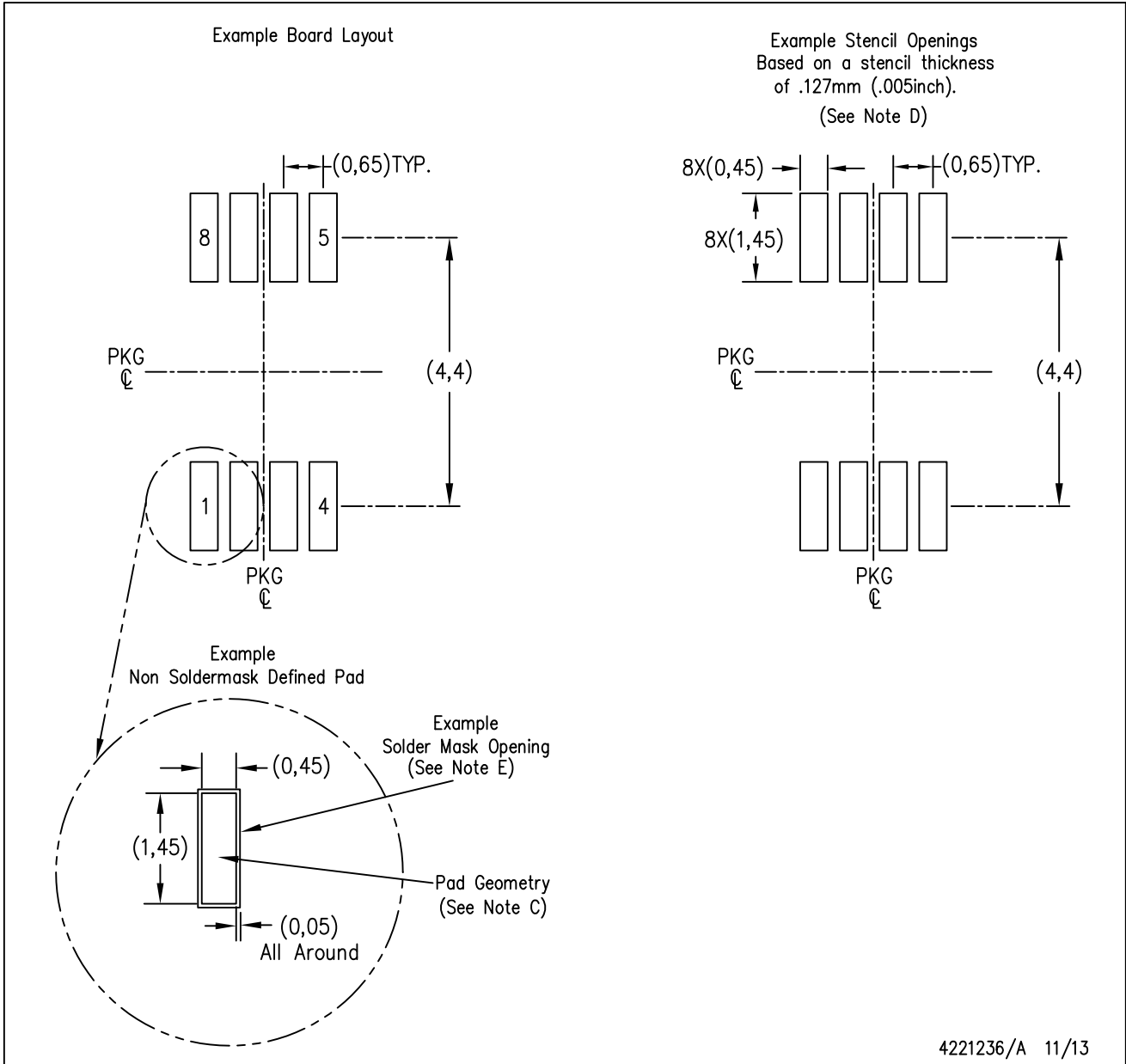

- NOTES:
- A. All linear dimensions are in millimeters.
 - B. This drawing is subject to change without notice.
 - C. Publication IPC-7351 is recommended for alternate designs.
 - D. Laser cutting apertures with trapezoidal walls and also rounding corners will offer better paste release. Customers should contact their board assembly site for stencil design recommendations. Refer to IPC-7525 for other stencil recommendations.
 - E. Customers should contact their board fabrication site for solder mask tolerances between and around signal pads.

D (R-PDSO-G8)

PLASTIC SMALL OUTLINE

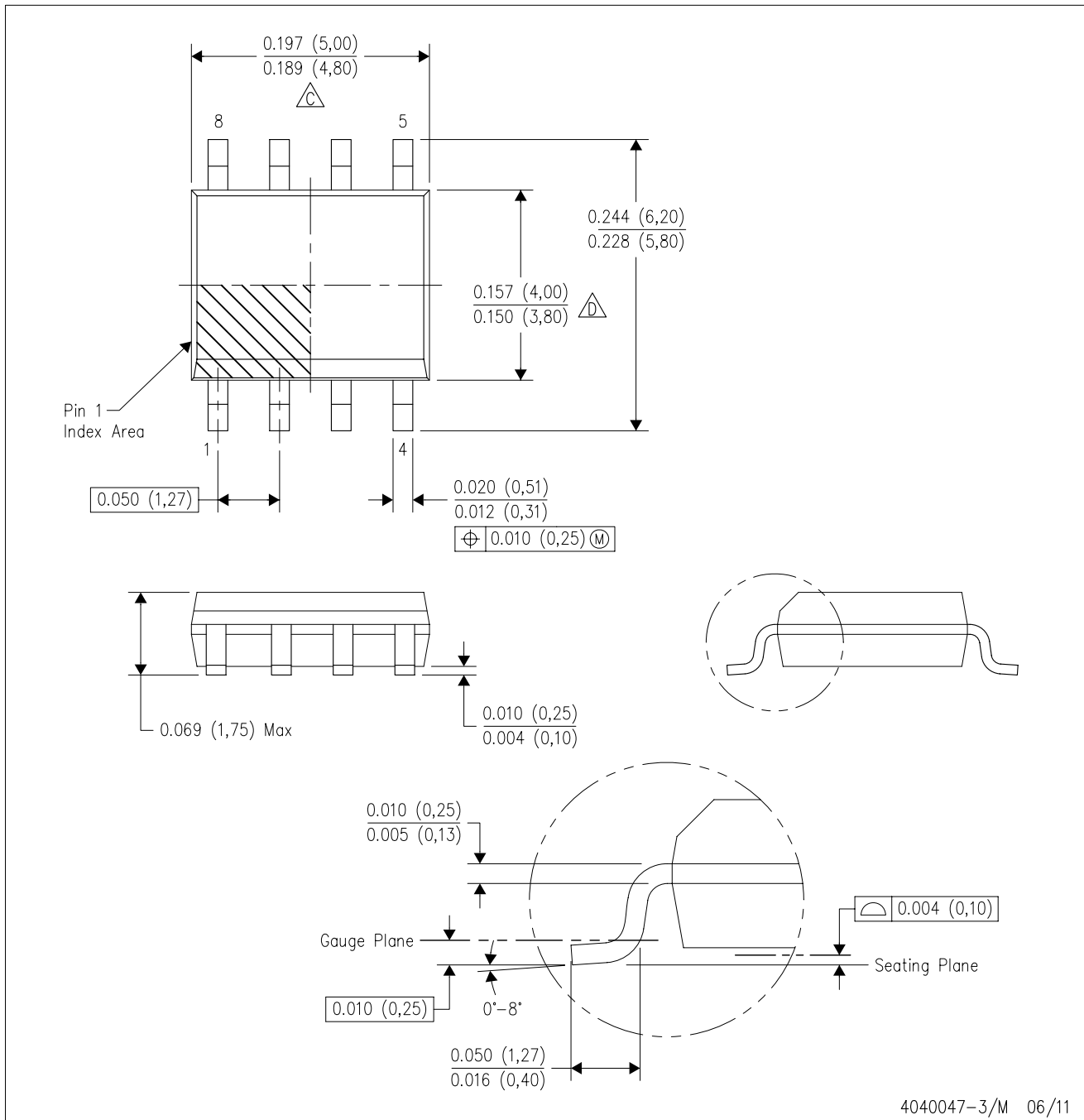

- NOTES:
- A. All linear dimensions are in inches (millimeters).
 - B. This drawing is subject to change without notice.
 - C. Body length does not include mold flash, protrusions, or gate burrs. Mold flash, protrusions, or gate burrs shall not exceed 0.006 (0,15) each side.
 - D. Body width does not include interlead flash. Interlead flash shall not exceed 0.017 (0,43) each side.
 - E. Reference JEDEC MS-012 variation AA.

D (R-PDSO-G8)

PLASTIC SMALL OUTLINE

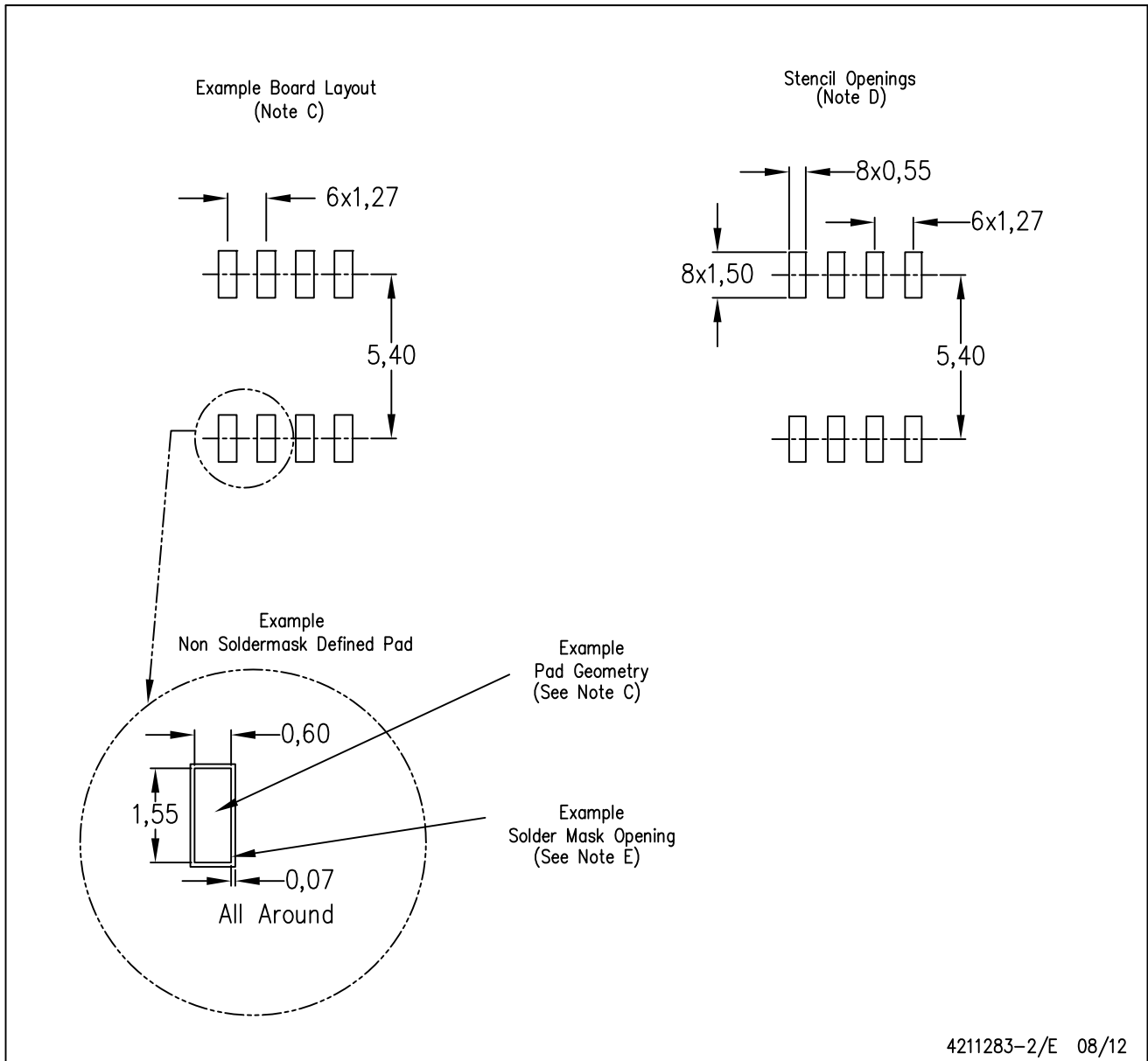

4211283-2/E 08/12

- NOTES:
- A. All linear dimensions are in millimeters.
 - B. This drawing is subject to change without notice.
 - C. Publication IPC-7351 is recommended for alternate designs.
 - D. Laser cutting apertures with trapezoidal walls and also rounding corners will offer better paste release. Customers should contact their board assembly site for stencil design recommendations. Refer to IPC-7525 for other stencil recommendations.
 - E. Customers should contact their board fabrication site for solder mask tolerances between and around signal pads.

IMPORTANT NOTICE

Texas Instruments Incorporated and its subsidiaries (TI) reserve the right to make corrections, enhancements, improvements and other changes to its semiconductor products and services per JESD46, latest issue, and to discontinue any product or service per JESD48, latest issue. Buyers should obtain the latest relevant information before placing orders and should verify that such information is current and complete. All semiconductor products (also referred to herein as "components") are sold subject to TI's terms and conditions of sale supplied at the time of order acknowledgment.

TI warrants performance of its components to the specifications applicable at the time of sale, in accordance with the warranty in TI's terms and conditions of sale of semiconductor products. Testing and other quality control techniques are used to the extent TI deems necessary to support this warranty. Except where mandated by applicable law, testing of all parameters of each component is not necessarily performed.

TI assumes no liability for applications assistance or the design of Buyers' products. Buyers are responsible for their products and applications using TI components. To minimize the risks associated with Buyers' products and applications, Buyers should provide adequate design and operating safeguards.

TI does not warrant or represent that any license, either express or implied, is granted under any patent right, copyright, mask work right, or other intellectual property right relating to any combination, machine, or process in which TI components or services are used. Information published by TI regarding third-party products or services does not constitute a license to use such products or services or a warranty or endorsement thereof. Use of such information may require a license from a third party under the patents or other intellectual property of the third party, or a license from TI under the patents or other intellectual property of TI.

Reproduction of significant portions of TI information in TI data books or data sheets is permissible only if reproduction is without alteration and is accompanied by all associated warranties, conditions, limitations, and notices. TI is not responsible or liable for such altered documentation. Information of third parties may be subject to additional restrictions.

Resale of TI components or services with statements different from or beyond the parameters stated by TI for that component or service voids all express and any implied warranties for the associated TI component or service and is an unfair and deceptive business practice. TI is not responsible or liable for any such statements.

Buyer acknowledges and agrees that it is solely responsible for compliance with all legal, regulatory and safety-related requirements concerning its products, and any use of TI components in its applications, notwithstanding any applications-related information or support that may be provided by TI. Buyer represents and agrees that it has all the necessary expertise to create and implement safeguards which anticipate dangerous consequences of failures, monitor failures and their consequences, lessen the likelihood of failures that might cause harm and take appropriate remedial actions. Buyer will fully indemnify TI and its representatives against any damages arising out of the use of any TI components in safety-critical applications.

In some cases, TI components may be promoted specifically to facilitate safety-related applications. With such components, TI's goal is to help enable customers to design and create their own end-product solutions that meet applicable functional safety standards and requirements. Nonetheless, such components are subject to these terms.

No TI components are authorized for use in FDA Class III (or similar life-critical medical equipment) unless authorized officers of the parties have executed a special agreement specifically governing such use.

Only those TI components which TI has specifically designated as military grade or "enhanced plastic" are designed and intended for use in military/aerospace applications or environments. Buyer acknowledges and agrees that any military or aerospace use of TI components which have **not** been so designated is solely at the Buyer's risk, and that Buyer is solely responsible for compliance with all legal and regulatory requirements in connection with such use.

TI has specifically designated certain components as meeting ISO/TS16949 requirements, mainly for automotive use. In any case of use of non-designated products, TI will not be responsible for any failure to meet ISO/TS16949.

Products

Audio	www.ti.com/audio
Amplifiers	amplifier.ti.com
Data Converters	dataconverter.ti.com
DLP® Products	www.dlp.com
DSP	dsp.ti.com
Clocks and Timers	www.ti.com/clocks
Interface	interface.ti.com
Logic	logic.ti.com
Power Mgmt	power.ti.com
Microcontrollers	microcontroller.ti.com
RFID	www.ti-rfid.com
OMAP Applications Processors	www.ti.com/omap
Wireless Connectivity	www.ti.com/wirelessconnectivity

Applications

Automotive and Transportation	www.ti.com/automotive
Communications and Telecom	www.ti.com/communications
Computers and Peripherals	www.ti.com/computers
Consumer Electronics	www.ti.com/consumer-apps
Energy and Lighting	www.ti.com/energy
Industrial	www.ti.com/industrial
Medical	www.ti.com/medical
Security	www.ti.com/security
Space, Avionics and Defense	www.ti.com/space-avionics-defense
Video and Imaging	www.ti.com/video

TI E2E Community

e2e.ti.com