

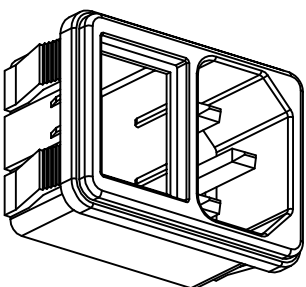

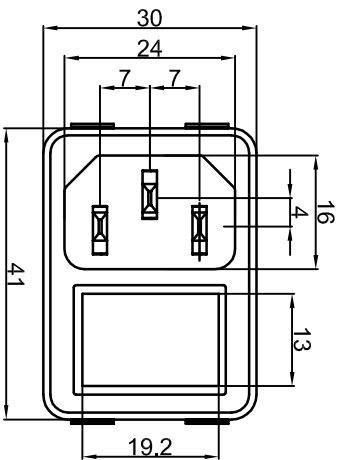



S-03

受控文件



Rating: 15A 250V AC (UL CUL )    
 10A 250V AC ( VDE CCC )   
 Insulation Resistance: DC 500V 100M  $\Omega$  Min.  
 Dielectric Strength: AC2000V 1 minute.  
 Operating Temperature: -10 °C~+70 °C;  
 MATERIAL:  
 Body:Nylon66  
 Terminal:Brass,Silver or Tin plated

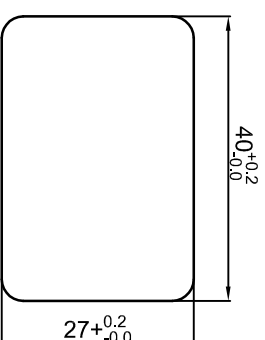
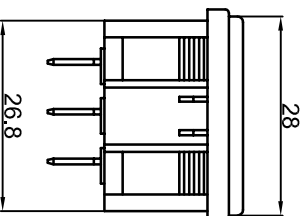
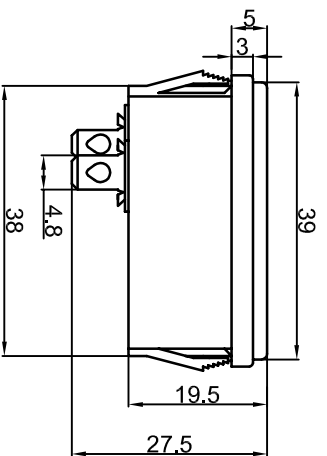

CUT-OUT



		公差 TOLERANCES		X $\pm$ 0.3 XX $\pm$ 0.15		角度 ANGLE $\pm$ 1°		单位 DIMENSION UNIT mm.	
		版本 VERSION	A1	比例尺 SCALE	NONE	日期 DATE	2008.07.08	品名 TITLE	S-03-12S-1
		核准 APPROVED BY	李新超	核对 CHECKED BY	李伟奇	绘图 DRAWN BY	姜庆勇	图号 DRAWING NO	S-03-12S-1_A1
A1	图纸重新整理发行	2009.09.04	N/A						
A0	New Issue	2008.07.08	N/A						
版本 VER.	变更说明 CHANGE DESCRIPTION	日期 DATE	ECN NO.						