

MESSRS 东莞立德有限公司

SPECIFICATION

METALLIZED POLYPROPYLENE FILM CAPACITOR

TYPE MPAV 450 K 224 0000 0200

DRAWING No. PSC703029

NISSEI ELECTRIC CO., LTD.

No. **160090**



安全に関する注意

コンデンサを使用するに当たり、使用環境、及び取り付け環境を確認の上、納入仕様書に規定した定格性能の範囲内でご使用下さい。

納入仕様書、添付注意事項の範囲を越えて使用しますと、ショート、オープン、発煙、発火に至る場合がありますので、定格性能の範囲内であることを確認願います。

尚、納入仕様書に記載のない項目、不明な内容については、必ずお問い合わせ下さい。

又、生命に影響を与える可能性がある装置、機器（生命維持装置、航空機用制御装置、自動車用制御装置等）に使用される場合にも必ずお問い合わせ下さい。

※本仕様書は、発行日より6ヶ月を経過して返却されなかった場合は、受領いただけなかったものと判断し、無効とさせていただきます事ご了承願います。



Cautions About Safety In Use of Capacitors

When using a capacitor, please use one within the range of values specified in the specification after checking the environments of using and mounting.

If used beyond the range specified in the specification or the attached cautions, it may lead to short circuit, open, smoking and firing.

Be sure to inquire of us as to the items which are not specified in the specification or are unclear to you.

Also, in case of using capacitors for such equipment or apparatus as may possibly affect human lives like life-support system, aircraft and automotive control systems, etc., please never fail to inquire of us as to further details.

If this specification is not returned within six months, we consider it not to be accepted by you and will make it null and void.

SPECIFICATION	METALLIZED POLYPROPYLENE FILM CAPACITOR	SPEC No. P S C 7 0 3 0 2 9
---------------	---	-----------------------------------

1. SCOPE

This specification defines general requirements for metallized polypropylene film capacitor MPA type (hereinafter called capacitor).

2. PARTS NUMBER CODE SYSTEM

M	P	A		*	0	4	5	0	K	2	2	4	0	0	0	0	0	2	0	0
①				②	③				④	⑤			⑥				⑦			

① Designation

MPA : Straight lead type

MPAF : Single-formed lead type

MPAV : Automatic vertical insertion type (Formed lead type)

② Internal use

③ Rated DC voltage

450 V.DC

④ Tolerance on capacitance

J : $\pm 5\%$, K : $\pm 10\%$

⑤ Capacitance Code

Capacitance value shall be given by 3-digit figure of which unit used is expressed in pF.

The first 2 digits are significant figures of the capacitance value, the third digit to indicate the number of additional zeros to follow the significant figure.

⑥ Model code (Internal use)

0200

<u>REVISIONS</u>	SIGNATURE	DATE
	DESIGNED <i>Y. Aotashiro</i>	<i>August 1, 2014</i>
	CHECKED <i>H. Obara</i>	<i>August 1, 2014</i>
	APPROVED <i>H. Kawagoe</i>	<i>August 1, 2014</i>

SPECIFICATION

METALLIZED POLYPROPYLENE FILM CAPACITOR

SPEC No.

P S C 7 0 3 0 2 9

⑦Lead dimension / Packing mode

Designation	Code			
MPA	0 0 0 0			
MPAF	Code	Lead spacing	Code	Lead spacing
	0 0 5 0	5.0mm	0 1 0 0	1 0.0mm
	0 0 7 5	7.5mm	0 1 5 0	1 5.0mm
MPAV	Code	Style		
	D 2 1 0	3		
	0 2 0 0	6		

3. RATING

3.1 Operating Temperature Range : Operating temperature range to capacitors shall be $-40^{\circ}\text{C}\sim+105^{\circ}\text{C}$ (Voltage derating in case of over 85°C).

3.1.1 Maximum Operating Temperature : Maximum value of capacitor's surface temperature (ambient temperature+self heating temperature rise+radiation and conduction heat from other electric supply sources) at which capacitors shall be capable of applying continuously.

3.1.2 Minimum Operating Temperature : Minimum temperature range at which capacitors shall be capable of applying continuously.

3.2 Rated voltage : The rated voltage shall be the voltage which can be continuously applied to a capacitor within the range of the working temperature and shall be 450V.DC. However, rated voltage shall be derated 1.5% at each 1°C in the range of $+85^{\circ}\text{C}\sim+105^{\circ}\text{C}$ as shown in the Fig. below.

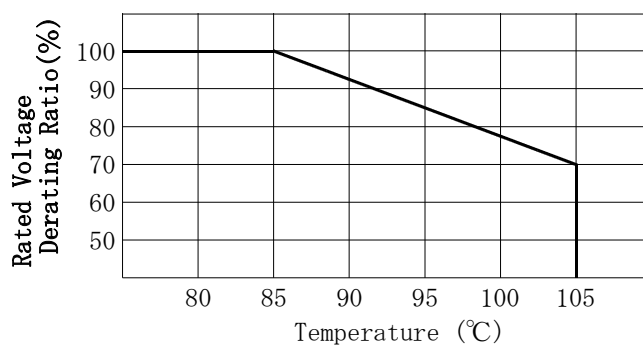

3.3 Capacitance range

$0.10\mu\text{F} \sim 2.2\mu\text{F}$ (E-12)

3.4 Tolerance on capacitance

$\pm 5\%$, $\pm 10\%$

SPECIFICATION

METALLIZED POLYPROPYLENE FILM CAPACITOR

SPEC No.

P S C 7 0 3 0 2 9

4. CONSTRUCTION OF CAPACITOR

Capacitor shall be non-inductive wound construction with dielectric of metallized polypropylene film, and wire lead shall be connected to capacitor element.

An exterior coating shall be given dampproofing and insulation treatments by using a flame-retardant epoxy resin (Recognized UL94V-0).

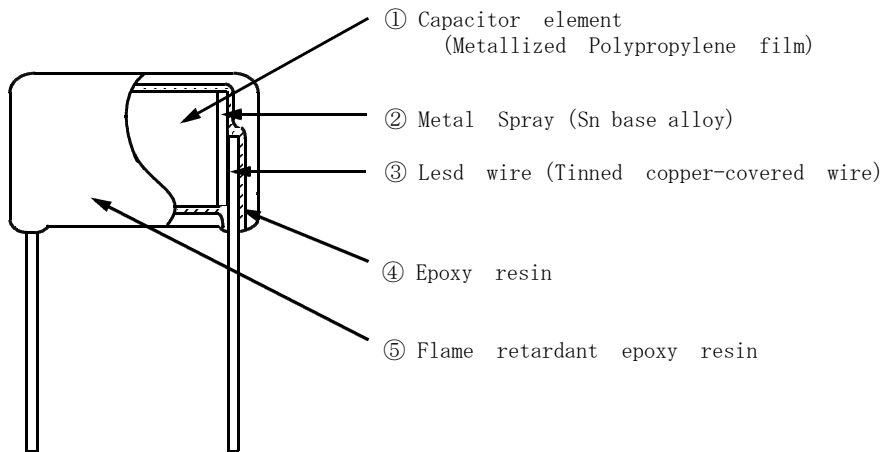

5. DIMENSIONS

Dimensions are specified in the attached sheet.

SPECIFICATION

METALLIZED POLYPROPYLENE FILM CAPACITOR

SPEC No.

P S C 7 0 3 0 2 9

6. MARKING

6.1 Marking item

The capacitors shall be marked clearly by an indelible way.

1) Nominal capacitance

Shall be marked with 3-digit code. Exp) 474, 105

2) Tolerance on capacitance

J or K

3) Production date code

Marking(Year) : It shall be indicated by the alphabet except G, I, O, Q, Y, Z.

Year	2010	2011	2012	2013	2014	2015	2016	2017	2018	2019	2020
Code	A	B	C	D	E	F	H	J	K	L	M

Marking(Month)

Month	1	2	3	4	5	6	7	8	9	10	11	12
Code	1	2	3	4	5	6	7	8	9	O	N	D

Marking(Week)

Week	1	2	3	4	5	6
Code	1	2	3	4	5	6

4) Rated DC voltage

Unit code V is omitted.

5) Manufacturer's Identification

N I S

6.2 Marking position

(Example)

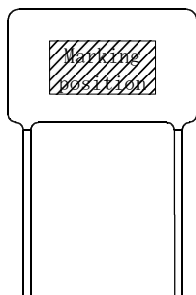

1 0 5 K 4 5 0
N I S E 8 1

SPECIFICATION	METALLIZED POLYPROPYLENE FILM CAPACITOR	SPEC No. P S C 7 0 3 0 2 9
---------------	---	--------------------------------------

7. PACKING

1) Straight leads and formed leads type.

The capacitors shall be put in poly-bag and packed in box marked with necessary information.

Inside packing case

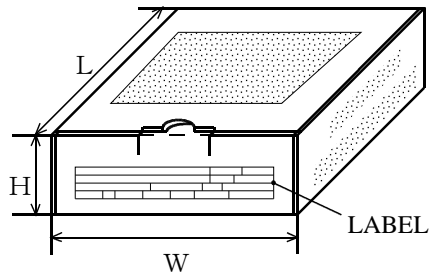

Dimension (mm)		
W	L	H
1 9 8	1 7 6	7 4

External packing case

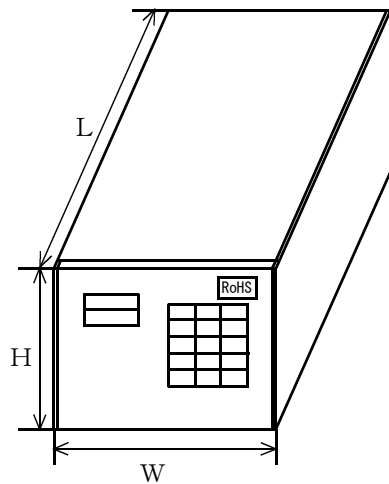

	Dimension (mm)		
	W	L	H
Inside packing case quantity			
2	1 6 5	2 1 0	2 0 0
4	2 1 0	3 1 0	"
6	2 3 5	4 1 0	"
8	3 1 0	4 1 0	"
1 2	4 1 0	4 5 0	"

Example)

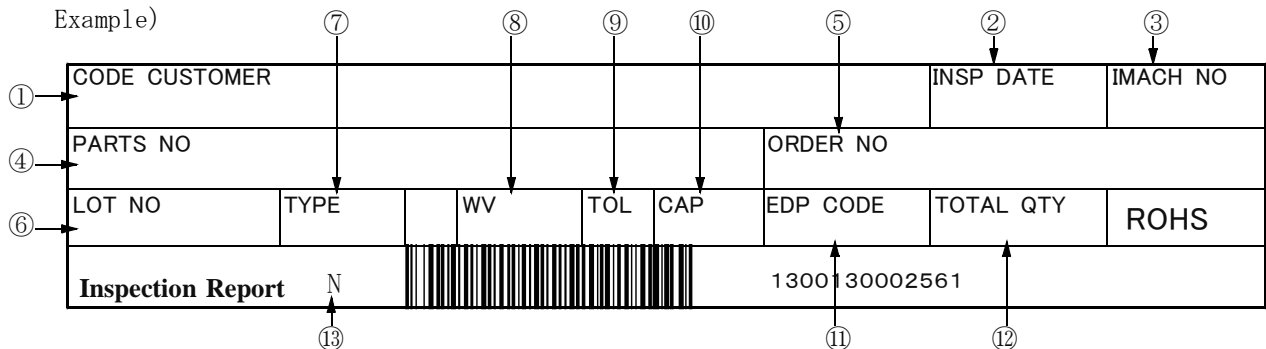

- ①CODE CUSTOMER ⑤ORDER NO ⑨TOL (%) ⑬Mark for identifying a new factory
- ②INSP DATE ⑥LOT NO ⑩CAP
- ③MACH NO ⑦TYPE ⑪EDP CODE
- ④PARTS NO ⑧W V ⑫QT (PCS)

2) Automatic vertical insertion type.

This is specified by the specification of automatic vertical insertion type.

SPECIFICATION	METALLIZED POLYPROPYLENE FILM CAPACITOR	SPEC No. P S C 7 0 3 0 2 9
<p>8. APPLICABLE STANDARD Unless otherwise specified, performance and a testing method shall comply with JIS C 5101-1:2010.</p> <p>9. DISUSE OF O.D.C. No ozone depleting chemicals are used at any stage of the manufacturing process.</p> <p>10. DISUSE OF PBB0, PBDPO, PBDPE, PBBs This products does not contain PBB0, PBDPO, PBDPE, PBBs.</p> <p>11. CERTAIN HAZARDOUS SUBSTANCES RESTRICTED BY RoHS DIRECTIVE In the product, materials to which certain hazardous substances restricted by RoHS Directive (2011/65/EU) (cadmium, hexavalent chromium, mercury, lead, PBB and PBDE) are added on purpose aren't used.</p> <p>12. PRODUCTION COUNTRY • CHINA</p>		

SPECIFICATION	METALLIZED POLYPROPYLENE FILM CAPACITOR	SPEC No. P S C 7 0 3 0 2 9
<p>1 3. CHARACTERISTICS AND TEST CONDITIONS</p> <p>13.1 TEST CONDITIONS</p> <p>The test and measurement, unless otherwise specified, the standard range of atmospheric conditions of marking measurements and test is as follows</p> <p style="padding-left: 40px;">Ambient temperature : 5 to 35°C</p> <p style="padding-left: 40px;">Relative humidity : 45 to 85%</p> <p>If there may be anydoubt on the results, measurements shall be made within the following limits.</p> <p style="padding-left: 40px;">Ambient temperature : 20±2°C</p> <p style="padding-left: 40px;">Relative humidity : 60 to 70%</p> <p>13.2 Electrical characteristics test</p>		
Item	Characteristics	Test conditions
Dielectric strength	Between terminations	No breakdown. However momentary breakdown is permissible.
	Between terminations and case	No breakdown.
Insulation resistance (Between terminations)	$C \leq 0.33 \mu F$ 30,000MΩ or more ----- $C > 0.33 \mu F$ 7,500Ω F or more	DC voltage specified below shall be applied for 1 minute, after which measurement shall be made. Test voltage : 100V. DC
Capacitance	Within the nominal tolerance.	Capacitance shall be measured with 1kHz±20%, 5Vrms max.
Tangent of loss angle	0.001 or less	

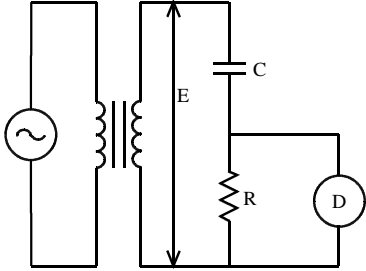
SPECIFICATION		METALLIZED POLYPROPYLENE FILM CAPACITOR	SPEC No. P S C 7 0 3 0 2 9
Item	Characteristics	Test conditions	
Connection of element	There shall be no intermittent contacts or open circuiting which would result in any needle deflection on the voltage detector.	<p>As in the diagramed circuit measure the variation of terminal voltage for the series resistor (R) while a weak impact is made on the test capacitor to check the bonding strength of the terminals to the capacitor.</p>  <p>C : Capacitor R : Series resistor $R(\Omega) = 150/C(\mu F)$ C = Nominal capacitance μF Ⓧ : Detector Internal impedance shall be large enough as compared with c. E : 100mV (peak value) or less</p>	
13.3 Mechanical characteristics test			
Item	Characteristics	Test conditions	
Termination strength	Tensile strength	Test capacitors shall be fixed, and unless otherwise specified, a tensile force of 10N shall be gradually applied to the axial of the leads, and then maintained for 30 ± 5 seconds.	
	Bending strength	Without mechanical damage, such as break of terminal damage.	The bend test shall consist of hanging a weight of 5N to the end of the leads and then rotating the capacitors 90 degrees in one direction, then to the starting point. This test shall be applied for 2.5 seconds per each time. At the same test speed, the capacitors shall be rotated 90 degrees in alternating direction, then return to the starting point.

SPECIFICATION		METALLIZED POLYPROPYLENE FILM CAPACITOR	SPEC No. P S C 7 0 3 0 2 9	
Item	Characteristics	Test conditions		
Vibration resistance	There shall be no short-circuits or open-circuits in the element and state of the connection shall be stable. Moreover, There shall be no anomalies in appearance after test.	The frequency shall be varied uniformly from 10Hz to 55Hz at 0.75mm amplitude and back to 10Hz in approximately 1 minute intervals. This test shall be applied 2 hours per each direction, total 6 hours.		
Solderability	At least 95% of the circumferential face of termination up to immersed level shall be covered with new solder.	Capacitor's leads shall be immersed into Flux (25% rosin) using sheltering board (Thickness : $1.5 \pm 0.5\text{mm}$) from radial test, then immersed into soldering bath at $245 \pm 3^\circ\text{C}$ for 3 ± 0.3 seconds up to the depth of 2~2.5mm from the bottom of the body. (Composition of solder : Sn96.5 Ag3 Cu0.5) Immersed and removing speed shall be $25 \pm 2.5\text{mm}/\text{sec}$.		
Resistance to soldering heat	Appearance	No visible damage.		
	Dielectric strength (Between terminations)	No breakdown.		
	Insulation resistance	$C \leq 0.33 \mu\text{F}$	30,000M Ω or more	
		$C > 0.33 \mu\text{F}$	7,500 ΩF or more	
	Tangent of loss angle	0.001 以下		
Capacitance change	Within $\pm 3\%$ of the initial value.			
Resistance to solvent	Marking	Markings shall be legible with ease.	After immersed in isopropyl-alcohol for 30 ± 5 seconds, the condition of markings on a capacitor shall be checked.	

SPECIFICATION		METALLIZED POLYPROPYLENE FILM CAPACITOR	SPEC No. P S C 7 0 3 0 2 9
13.4 Climatic test			
Item		Characteristics	Test conditions
Cold	Appearance	No visible damage.	The capacitor shall be maintained at $-40\pm 2^{\circ}\text{C}$ for $2\pm\frac{1}{6}$ hours, after which measurements shall be made.
	Capacitance change	Within +3, -0% of the initial value at $+20^{\circ}\text{C}$.	
Dry heat	Appearance	No visible damage.	The capacitor shall be maintained at $+85\pm 2^{\circ}\text{C}$ for $2\pm\frac{1}{6}$ hours, after which measurements shall be made.
	Insulation resistance	$C \leq 0.33 \mu\text{F}$ ----- $50\text{M}\Omega$ or more $C > 0.33 \mu\text{F}$ ----- $10\text{M}\Omega$ or more	
	Capacitance change	Within +0, -4% of the initial value at $+20^{\circ}\text{C}$.	
Humidity resistance (steady state)	Appearance	No visible damage.	The capacitor shall be put into the test chamber and left under the condition of relative humidity 90~95% at $40\pm 2^{\circ}\text{C}$ for $500\pm\frac{2}{6}$ hours. After the test, the capacitor shall be left under the ordinary condition for 1~2 hours. The capacitors shall withstand 150% of rated DC voltage for 1 minute.
	Dielectric strength (Between terminations)	No breakdown.	
	Insulation resistance	$C \leq 0.33 \mu\text{F}$ ----- $3,500\text{M}\Omega$ or more $C > 0.33 \mu\text{F}$ ----- $1,000\text{M}\Omega$ or more	
	Tangent of loss angle	0.003 or less	
	Capacitance change	Within $\pm 5\%$ of the initial value.	
Endurance test for humidity	Appearance	No visible damage.	The rated voltage shall be continuously applied to the capacitor in the test chamber at a relative humidity of 90~95% at $40\pm 2^{\circ}\text{C}$ for $500\pm\frac{2}{6}$ hours. After the test, the capacitor shall be left under the ordinary condition for 1~2 hours. The capacitors shall withstand 150% of rated DC voltage for 1 minute.
	Dielectric strength (Between terminations)	No breakdown.	
	Insulation resistance	$C \leq 0.33 \mu\text{F}$ ----- $3,500\text{M}\Omega$ or more $C > 0.33 \mu\text{F}$ ----- $1,000\text{M}\Omega$ or more	
	Tangent of loss angle	0.003 or less	
	Capacitance change	Within $\pm 10\%$ of the initial value.	

SPECIFICATION		METALLIZED POLYPROPYLENE FILM CAPACITOR	SPEC No. P S C 7 0 3 0 2 9	
Item	Characteristics	Test conditions		
Endurance test for high temperature	Appearance	No visible damage.		
	Dielectric strength (Between terminations)	No breakdown.		
	Insulation resistance	$C \leq 0.33 \mu F$ 3,500M Ω or more	The voltage of The voltage of 125% of rated voltage shall be continuously applied to the capacitor through a series of 20~1,000 Ω per 1 voltage in the test chamber at $85 \pm 3^\circ C$ for $1,000 \pm 4\frac{8}{8}$ hours. (However, for 450V.DC, 500V.DC shall be applied.) After the test, the capacitor shall be left under the ordinally condition for 1~2 hours. The capacitors shall withstand 150% of rated DC voltage for 1 minute	
		$C > 0.33 \mu F$ 1,000 ΩF or more		
	Tangent of loss angle	0.003 or less		
Capacitance change	Within $\pm 10\%$ of the initial value.			
Rapid change of temperature	Appearance	No visible damage.		
	Dielectric strength (Between terminations)	No breakdown.		
	Insulation resistance	$C \leq 0.33 \mu F$ 7,000M Ω or more	The capacitor put into the test chamber and continuously left for the specified duration at each temperature of the step 1 to 4 given in Table 1. This operation is considered as 1 cycle and 5 cycles shall be continuously repeated. After the test, the capacitor shall be left under the ordinally condition for 1~2 hours.	
		$C > 0.33 \mu F$ 2,000 ΩF or more		
	Tangent of loss angle	0.003 or less		
Capacitance change	Within $\pm 5\%$ of the initial value.			

Step	Temperature	Maintained time
1	$-40 \pm \frac{0}{3}^\circ C$	30 \pm 3 minutes
2	Normal temperature	3 minutes max
3	$+85 \pm \frac{3}{0}^\circ C$	30 \pm 3 minutes
4	Normal temperature	3 minutes max

SPECIFICATION

METALLIZED POLYPROPYLENE FILM CAPACITOR

SPEC No.

P S C 7 0 3 0 2 9

1 4. REGULATION IN USAGE

14.1 Permissible voltage

When containing a portion of D.C.Bias, the crasy value (peak voltage V_{o-p}) waveform shall not exceed the rated voltage.

14.2 Permissible current to frequency

A permissible current is regulated by both a root-mean-square value current and a peak current. A root-mean-square value current is to be a permissible current value to frequency attached. A permissible peak current is determined by a permissible peak current value attached.

The values of continuous peak current in the allowable peak current shall be those of continuous current, and the values of single peak current shall be those of discontinuous current such as rush current in switching on or off. The highest number of times of single peak current shall be limited to 10,000 times. (In case of exceeding 10,000 times, please contact us.)

Permissible Peak Current (Pulse Current)

Capacitance Symbo	Capacitance (μ F)	450V. DC	
		Single (A_{o-p})	Continual (A_{o-p})
104	0.10	8.06	1.14
124	0.12	10.37	1.38
154	0.15	12.96	1.72
184	0.18	15.55	2.06
224	0.22	19.01	2.52
274	0.27	23.33	3.10
334	0.33	28.51	3.78
394	0.39	33.70	4.47
474	0.47	23.13	3.05
564	0.56	27.55	3.63
684	0.68	33.46	4.41
824	0.82	40.34	5.31
105	1.0	49.20	6.48
125	1.2	59.04	7.78
155	1.5	44.40	6.05
185	1.8	53.28	7.26
225	2.2	65.12	8.86

Furthermore, when used beyond 85~105°C at temperature of capacitor surface, derate the permissible current rated as shown below.

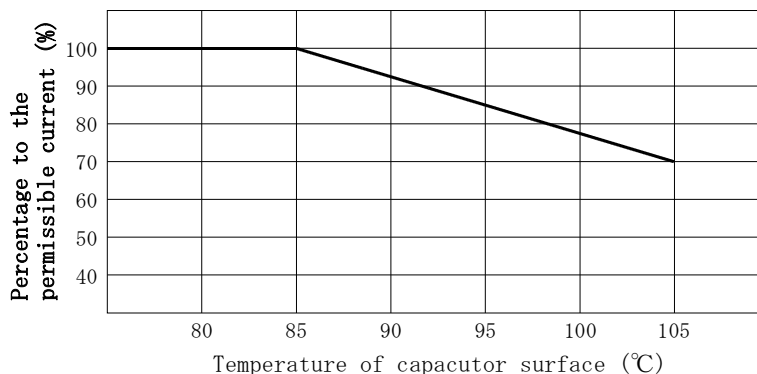

SPECIFICATION

METALLIZED POLYPROPYLENE FILM CAPACITOR

SPEC No.

P S C 7 0 3 0 2 9

14.3 Soldering

When soldering a capacitor, heat in soldering is conducted to the elements of the capacitor from lead wire and an enclosure, and hence it should be noted that soldering under high temperature and a long period may cause deterioration of characteristic or breakdown of capacitors.

When mounting a capacitor together with chip components, it shall be carried out after curing an adhesive for chip components.

(1) When subjecting a capacitor to flow soldering

Using a capacitor with formed leads is recommended when subjecting a capacitor to flow soldering.

When using a capacitor with straight leads or using a capacitor under the following circumstances for reasons of mounting, the temperature of the capacitor's innards in soldering (temperature of the point of measurement shown below) shall be 140°C or less.

- When using a double-sided through-hole substrate.
- Where other components are installed around a capacitor and heat is trapped.
- When mounting a capacitor in a place near the edge of a substrate.

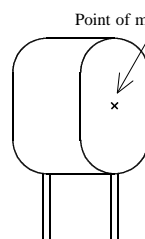

※Temperature measurements shall be made by inserting by about 2mm the tip of a thermo couple having a diameter of 0.2mm or less into a hole made in an outer covering.

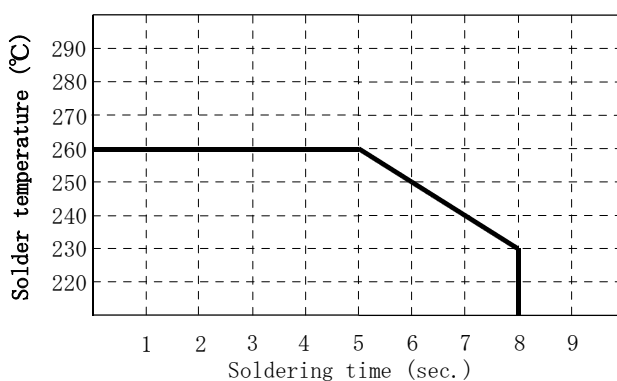

Preheating condition : 120°C,
for one minute

(2) When using soldering iron

Iron tip temperature less than 350°C

Soldering time (sec.) within 3 seconds

(3) When soldering a capacitor mounted on the board with chip-type components

Please avoid mounting a capacitor with chip-type components on a printed circuit board because the application of hardening heat for bonding chip components shall cause deterioration of the dielectric film.

周波数に対する許容電流特性

CHARACTERISTICS OF PERMISSIBLE CURRENT TO FREQUENCY

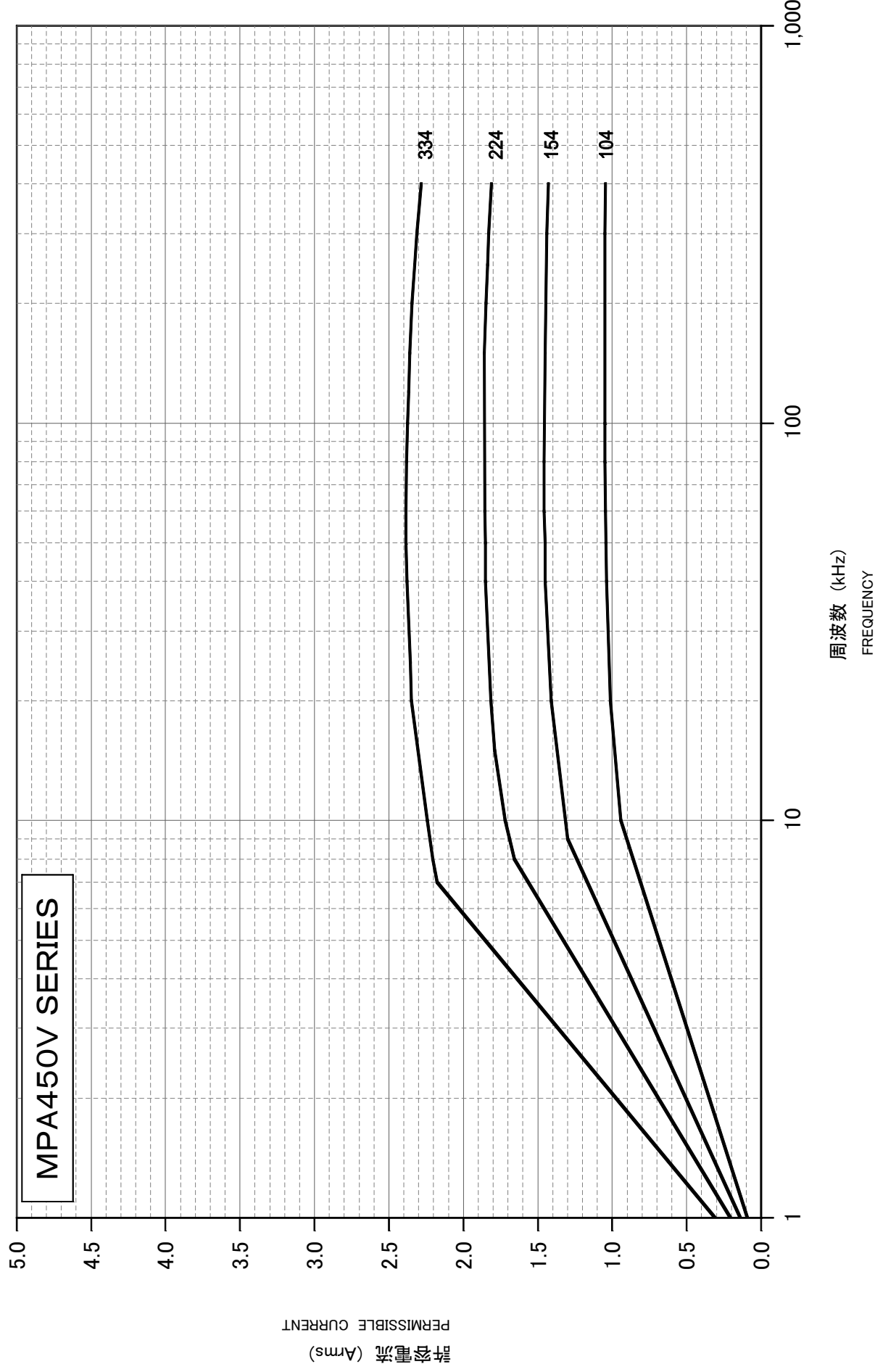

SPECIFICATION

METALLIZED POLYPROPYLENE FILM CAPACITOR

SPEC No.

P S C 7 0 3 0 2 9

Drawing direction

• MPA : Straight lead type

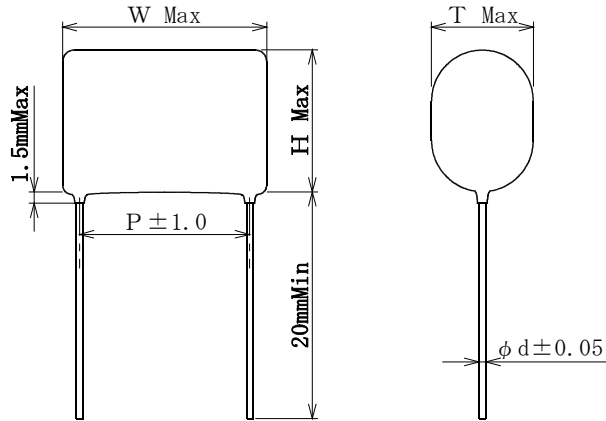

• MPAF : Single-formed lead type

《Type A》

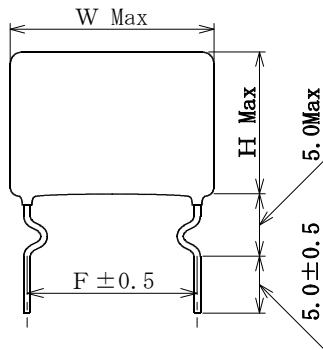

《Type B》

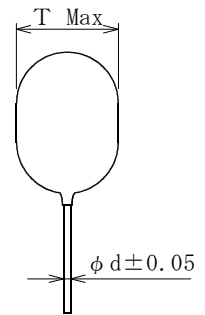
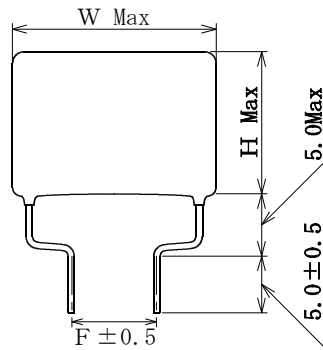

SPECIFICATION

METALLIZED POLYPROPYLENE FILM CAPACITOR

SPEC No.

P S C 7 0 3 0 2 9

MPA-450V. DC

Parts No.	Capacitance (μ F)	Dimensions (mm)											
		W	H	T	P	F	F	F	F	F	ϕ d		
MPA□□0450□1040000□□□□	0.10	13.0	9.6	5.2	10.0	5.0	B	7.5	A	10.0	A		0.6
MPA□□0450□1240000□□□□	0.12	"	9.9	5.5	"	"	"	"	"	"	"		"
MPA□□0450□1540000□□□□	0.15	"	10.3	5.9	"	"	"	"	"	"	"		"
MPA□□0450□1840000□□□□	0.18	"	10.7	6.2	"	"	"	"	"	"	"		"
MPA□□0450□2240000□□□□	0.22	"	11.1	6.7	"	"	"	"	"	"	"		"
MPA□□0450□2740000□□□□	0.27	"	12.1	6.9	"	"	"	"	"	"	"		"
MPA□□0450□3340000□□□□	0.33	"	12.7	7.5	"	"	"	"	"	"	"		"
MPA□□0450□3940000□□□□	0.39	"	13.3	8.0	"	"	"	"	"	"	"		"
MPA□□0450□4740000□□□□	0.47	18.3	12.0	6.8	15.0	"	"	"	B	"	B	15.0	A
MPA□□0450□5640000□□□□	0.56	"	12.5	7.3	"	"	"	"	"	"	"	"	"
MPA□□0450□6840000□□□□	0.68	"	13.1	7.9	"	"	"	"	"	"	"	"	0.8
MPA□□0450□8240000□□□□	0.82	"	13.7	8.5	"	"	"	"	"	"	"	"	"
MPA□□0450□1050000□□□□	1.0	"	14.5	9.2	"	"	"	"	"	"	"	"	"
MPA□□0450□1250000□□□□	1.2	"	15.2	10.0	"	"	"	"	"	"	"	"	"
MPA□□0450□1550000□□□□	1.5	"	16.3	11.1	"	"	"	"	"	"	"	"	"
MPA□□0450□1850000□□□□	1.8	"	18.1	11.3	"	"	"	"	"	"	"	"	"
MPA□□0450□2250000□□□□	2.2	"	19.2	12.4	"	"	"	"	"	"	"	"	"

SPECIFICATION

METALLIZED POLYPROPYLENE FILM CAPACITOR

SPEC No.

P S C 7 0 3 0 2 9

SPECIFICATION OF TAPING FOR AUTOMATIC INSERTION (Type MPAV)

1. SCOPE

This specification applies to the taping dimensions and performance required for film capacitors used in the automatic radial insertion system.

Style of packing : Ammo pack

2. TAPING DIMENSIONS

Type	Taping style	STYLE-3	STYLE-6
	Rated voltage	(D210)	(0200)
M P A V	450V. DC	104~105	104~155

3. TAPING PERFORMANCE (to be satisfied with the following point)

3-1. Appearance : To be no damages or cracks on components and the tape.

3-2. Missing components : A maximum of 3 consecutive components may be missing.

3-3. Tip of the tape : To leave the blank tape more than 4.5 feed hole pitch from the start, and the end of the tape.

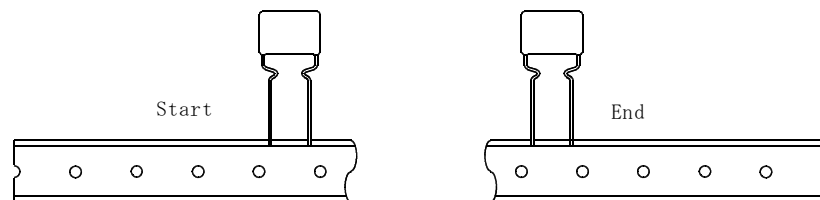

3-4. Tape splicing : Tape splicing may be done with (1) or (2).

(1) The carrier tape (include hold-down tape) shall be cut at the center of hole and hole, and spliced with tape.

(2) The carrier tape (include hold down tape) shall be cut at the center of hole, and spliced with splicing tape.

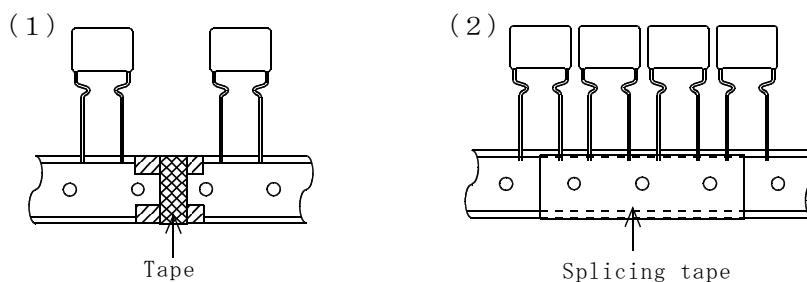

SPECIFICATION

METALLIZED POLYPROPYLENE FILM CAPACITOR

SPEC No.

P S C 7 0 3 0 2 9

3-5. Adhesive strength : When pulling an adhesive tape in W direction (upward) using a push-and-pull scale, adhesive strength shall be 3N or more

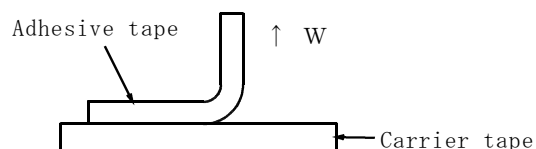

3-6. Tensile test : When pulling a test sample by the force 10N, there shall be no gaps or breakdowns.

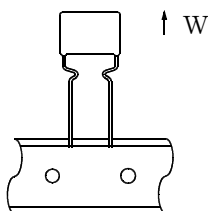

3-7. Moisture resistance : A taped test sample shall be left in a chamber with a temperature of 40°C and RH95% for 96 hours. Then after being left for one hour at room temperature the test sample shall be submitted to a tensile test of item 3.6.

3-8. Temperature cycling test : A test sample shall be submitted to 5 cycles of temperature cycling test.

One cycle consists of : 2 hours at -40°C
2 hours at +85°C

Then after being left for one hour at room temperature, the test sample shall be submitted to a tensile test of item 3.6.

4. BOX DIMENSIONS

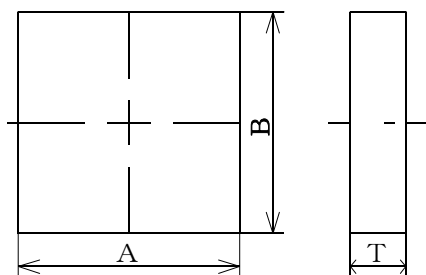

(Unit : mm)

Type	A	B	T
e	330±7	330±7	55±5

SPECIFICATION

METALLIZED POLYPROPYLENE FILM CAPACITOR

SPEC No. _____

P S C 7 0 3 0 2 9

5. STYLE OF PACKING (Ammo pack)

5-1. Packaging

- * Fold the tape in the cardboard box, with hold-down tepe turning up against an outlet opening.
- * Thread the feed hole with a axle and fix the tape.

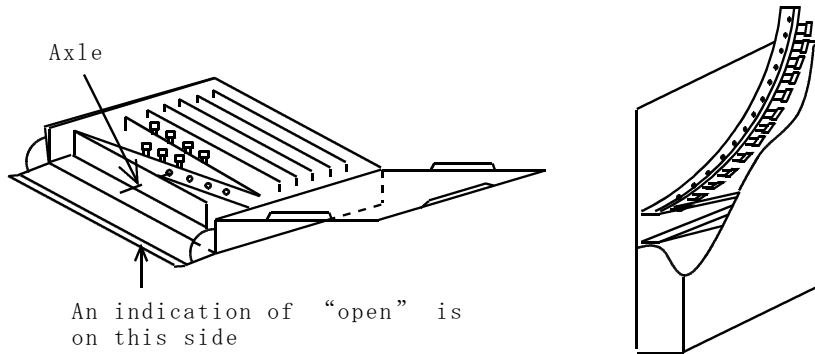

5-2. Marking

The following particulars shall be labelled on the surface of a box.

Example)

①	CODE CUSTOMER	⑦	⑧	⑨	⑩	⑤	②	③
	INSP DATE						IMACH NO	
④	PARTS NO					ORDER NO		
⑥	LOT NO	TYPE	WV	TOL	CAP	EDP CODE	TOTAL QTY	ROHS
	Inspection Report		N			1300	30002561	
	⑬					⑪	⑫	

- ①CODE CUSTOMER
- ⑤ORDER NO
- ⑨TOL (%)
- ⑬Mark for identifying a new factory
- ②INSP DATE
- ⑥LOT NO
- ⑩CAP
-
- ③MACH NO
- ⑦TYPE
- ⑪EDP CODE
-
- ④PARTS NO
- ⑧W V
- ⑫QT (PCS)
-

SPECIFICATION

METALLIZED POLYPROPYLENE FILM CAPACITOR

SPEC No.

P S C 7 0 3 0 2 9

Type M P A V	394 ~ 684	250V. DC
STYLE - 5	124 ~ 474	400V. DC
(0200)	124 ~ 474	450V. DC
	563 ~ 224	630V. DC

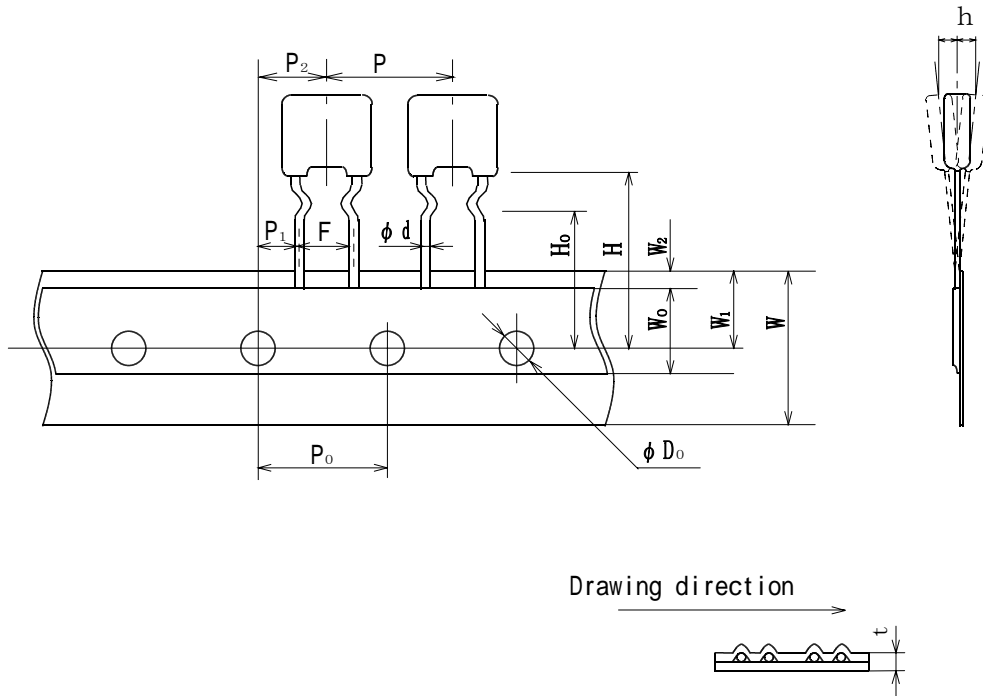

(Unit : mm)

P	P ₀	(1) P ₁	P ₂	φ d	(1) F	(2) Δ h	W	W ₀	W ₁	(3) W ₂	H	(1) H ₀	φ D ₀	t
15.0	15.0	3.75	7.5	0.6 or 0.8	7.5	0	18.0	≥5.0	9.0	3.0 Max	22.0 Max	16.0	4.0	0.7
±1.0	±0.3	±0.7	±1.3	±0.05	±0.8 ±0.2	±2.0	±1.0 ±0.5	—	±0.5	—	—	±0.5	±0.2	±0.2

(1) To be measured under the clinch-position.

(2) To be measured the top of component.

(3) Hold-down tape is not to exceed over the carrier tape.

SPECIFICATION

METALLIZED POLYPROPYLENE FILM CAPACITOR

SPEC No.

P S C 7 0 3 0 2 9

Packing quantity

MPAV-450V.DC (Unit : pcs)

Capacitance (μ F)	STYLE-3 (D210)	STYLE-6 (0200)
0.10	500	500
0.12	"	"
0.15	"	"
0.18	"	400
0.22	"	"
0.27	"	"
0.33	400	300
0.39	"	"
0.47	500	400
0.56	400	300
0.68	"	"
0.82	"	"
1.0	300	"
1.2		"
1.5		200

	Cautions about safety In use of Capacitors	Registry No. H W C 7 0 3 0 2 9	
	(MPA type)	Rev. No. 0 1	Sheet No. 1 / 2

When using a capacitor, please use one within the range of the specified values in the specification after checking the environments of using and mounting.

If used beyond the range specified in the specification or the attached cautions, it may lead to short circuit, open, smoking and firing.

Be sure to inquire of us as to the items which are not specified in the specification or are unclear to you.

Also, in case of using capacitors for such equipment or apparatus as may possibly affect human lives like life-support systems, aircraft and automotive control system, etc., please never fail to inquire of us as to further details.

1. Operating temperature and humidity

- (1) In actual use, make sure that the operating temperature is within the range specified in the specification.
- (2) Even if the operating temperature is within the specified range, sudden change in the operating temperature may lead to cracks on the enclosure and result in deterioration of the insulation resistance or the increase in tangent of loss angle by absorbing moisture through cracks on the enclosure. Please take good care of the operating temperature.
- (3) Please avoid using a capacitor in high humidity which may lead to the condensation as much as possible.

Even if there are no cracks or damage on an enclosure, deterioration of the insulation resistance or the increase in tangent of loss angle, etc. may be caused by absorbing moisture. Therefore, please be careful when using a capacitor.

2. When using a capacitor in a circuit except a d.c. one

When using a capacitor in a circuit except a d.c. one, a capacitor shall be used below the permissible current to frequency.

When used beyond the specified values, the capacitor surface temperature may rise due to the occurrence of corona charge or self heat generation of a capacitor and it may result in a short life, the destruction of the dielectric or the lowering of the insulation resistance.

At worst smoking or firing may be led.

3. Soldering

When soldering a capacitor, heat in soldering is conducted to the inside of the capacitor through lead wires and an enclosure.

Therefore soldering at high temperature and for hours may cause deterioration of characteristics or breakdown of a capacitor.

Be sure to solder a capacitor within the range specified in the specification when soldering.

In case of soldering beyond the range recommended by us, please inquire of us as to the details in advance.

- (1) Avoid soldering over again in a short time.

When dipping again in order to correct, dipping must be applied after the temperature of a capacitor comes down to a room temperature and within twice.

- (2) Avoid any work that puts the stress on lead wires of a capacitor such as correction of the position right after soldering.
- (3) When soldering with a soldering iron, please see to it lest a soldering iron should touch the body of a capacitor directly.

	Cautions about safety In use of Capacitors	Registry No. H W C 7 0 3 0 2 9	
	(MPA type)	Rev. No. 0 1	Sheet No. 2 / 2

4. Mounting

- (1) When inserting a lead wire into the printed circuit board, the stress put on a lead wire shall be within the following range.
 - ① Bending of lead wire
When bending a lead wire vertically and then restoring straight, bending of a lead wire in the same place shall be less than two cycles. (One cycle -- bending at 90° and restoring straight)
 - ② Twisting of lead wire
Twisting of a lead wire should be carried out within a turn (a 360° turn) in total.
 - ③ Pulling of lead wire
The load in pulling of a lead wire shall be less than 20N.
In case that the above stress is combined together, the value in application should be set less than half of each value.
- (2) When mounting a capacitor by force owing to the difference of the space between lead wires of a capacitor from the space between the holes on the printed circuit board, be careful.
It may cause breakage of a lead wire or cracks on coating resin.
- (3) When mounting a capacitor of large size or a capacitor on the equipment affected by vibrations, fix the body of a capacitor with resin etc. which has no effect on a capacitor.
However, resin used for fixing shall be a flame retardant and minimum.
- (4) Mount a capacitor lest it should touch other parts.
Especially in case of touching a part with self heat generation, a capacitor may deteriorate due to heat and short circuit may be easily caused owing to lowering of dielectric strength or deterioration of the insulation resistance, etc..

5. Cleaning

- (1) When using the solvents for cleaning, use alcohol derivative cleaning solvents (isopropyl alcohol, etc).
- (2) Since a small amount of ingredient contained in flux may lead to corrosion of terminations of the capacitor or chemical change of the capacitor element, be sure to clean a printed circuit board right after soldering.
- (3) The temperature for drying after cleaning shall be less than the maximum operating temperature.
- (4) When cleaning with solvents but alcohol derivatives, please inquire of us in advance.

6. Storing and waste

- (1) Store under the conditions not exceeding -10 °C ~ +40 °C, 75%RH in the room and avoid storing in the place filled with a sudden change in the temperature, the direct sunlight or corrosive gases (hydrogen sulfide, sulfurous acid, chlorine and ammonia, etc.).
- (2) A long-term storage may cause deterioration of characteristics of a capacitor due to absorbing moisture little by little.
Therefore, be sure to use after checking its characteristics and solderability if stored for over one year.
- (3) As capacitors are classified into industrial waste, please ask experts to dispose of them.

7. The others

Please refer to "Guideline of notabilia for fixed plastic film capacitors for use in electronic equipment" published by Electronic Industries Association of Japan (EIAJ RCR-2350) unless specified in the specification.