







313/315 Series Lead-Free 3AG, Slo-Blo® Fuse



Agency Approvals

| Agency | Agency File Number | Ampere Range |
|---|--|--|
|  | E 10480 | 0.010A - 10A** |
|  | 29862 | 0.010A - 10A**/15A** |
|  | E 10480 | 10A - 30A |
|  | 313 Series (Cartridge): NBK040205-E10480B NBK040205-E10480D | 1-5A 6.25- 10A** |
| | 315 Series (Leaded): NBK040205-E10480F NBK040205-EO1480H NBK280906-JP1021 | 1-5A 6.25-10A** 15** |
|  | SU05001-6004 SU05001-5007 SU05001-5008 SU05001-5009 | 2.25-2.5A 2.8A - 3.2A 4A - 6.3A 7A-8A |
|  | N/A | 0.010A - 10A**/15A** |

** See note under Electrical Characteristics by item

Additional Information



Datasheet
313 Series



Resources
313 Series



Samples
313 Series



Datasheet
315 Series



Resources
315 Series



Samples
315 Series



Accessories
313 & 315 Series

For recommended fuse accessories for this product series, see '[Recommended Accessories](#)' section.

Description

The 3AG Slo-Blo® fuse solves a broad range of application requirements while offering reliable performance and cost-effective circuit protection.

The fuse catalog number with the suffix "ID" instantly identifies itself upon opening by showing a discoloration of its glass body. Guesswork and time consuming circuit testing are eliminated. This unique design offers the same quality performance characteristics as the standard 3AG Slo-Blo® Fuse design.

Features

- In accordance with UL Standard 248-14
- Available in cartridge and axial lead format and with various forming dimensions
- RoHS compliant and Lead-free

Applications

Used as supplementary protection in appliance or utilization equipment to provide individual protection for components or internal circuits.

Electrical Characteristics by Series

| % of Ampere Rating | Ampere Rating | Opening Time |
|--------------------|---------------|-------------------------------|
| 100% | 10mA – 30A | 4 hours, Minimum |
| 135% | 10mA – 30A | 1 hour, Maximum |
| 200% | 10mA – 15A | 5 sec., Min., 30 sec., Max |
| | 20A – 30A | 5 sec., Min., 60 sec Max |

Electrical Characteristic Specifications by Item

| Amp Code | Ampere Rating (A) | Voltage Rating (V) | Interrupting Rating | Nominal Cold Resistance (Ohms) | Nominal Melting I ² t (A ² sec) | Agency Approvals | | | | | |
|----------|-------------------|--------------------|---------------------------|--------------------------------|---|------------------|----|-----|----|------|----|
| | | | | | | UL | SF | CCC | RU | PS E | CE |
| .010 | 0.01 | 250 | 35A@250Vac 10KA@125Vac | 4300.0000 | 0.000121 | x | x | | | | x |
| .031 | 0.031 | 250 | | 430.0000 | 0.00303 | x | x | | | | x |
| .040 | 0.04 | 250 | | 300.0000 | 0.00630 | x | x | | | | x |
| .062 | 0.062 | 250 | | 120.0000 | 0.0210 | x | x | | | | x |
| .100 | 0.1 | 250 | | 43.0000 | 0.0850 | x | x | | | | x |
| .125 | 0.125 | 250 | | 30.0000 | 0.152 | x | x | | | | x |
| .150 | 0.15 | 250 | | 20.0000 | 0.270 | x | x | | | | x |
| .175 | 0.175 | 250 | | 8.6700 | 0.177 | x | x | | | | x |
| .187 | 0.187 | 250 | | 8.0100 | 0.230 | x | x | | | | x |
| .200 | 0.2 | 250 | | 6.5900 | 0.270 | x | x | | | | x |
| .250 | 0.25 | 250 | | 4.2700 | 0.385 | x | x | | | | x |
| .300 | 0.3 | 250 | | 3.1350 | 0.730 | x | x | | | | x |
| .375 | 0.375 | 250 | | 2.0950 | 1.23 | x | x | | | | x |
| .400 | 0.4 | 250 | | 1.8750 | 1.35 | x | x | | | | x |
| .500* | 0.5 | 250 | | 1.2600 | 2.55 | x | x | | | | x |
| .600 | 0.6 | 250 | | 0.9120 | 4.00 | x | x | | | | x |
| .700 | 0.7 | 250 | | 0.7000 | 5.90 | x | x | | | | x |
| .750 | 0.75 | 250 | | 0.6215 | 7.16 | x | x | | | | x |
| .800 | 0.8 | 250 | | 0.5540 | 8.00 | x | x | | | | x |
| 001.* | 1 | 250 | | 0.3750 | 14.0 | x | x | | | x | x |
| 01.2 | 1.2 | 250 | 0.2780 | 21.5 | x | x | | | x | x | |
| 1.25 | 1.25 | 250 | 0.2600 | 24.0 | x | x | | | x | x | |
| 01.5* | 1.5 | 250 | 0.1910 | 38.0 | x | x | | | x | x | |
| 01.6 | 1.6 | 250 | 0.1710 | 49.6 | x | x | | | x | x | |
| 01.8 | 1.8 | 250 | 0.1410 | 92.0 | x | x | | | x | x | |
| 002.* | 2 | 250 | 0.1169 | 77.0 | x | x | | | x | x | |
| 2.25 | 2.25 | 250 | 0.0968 | 121 | x | x | x | | x | x | |
| 02.5 | 2.5 | 250 | 0.0811 | 199 | x | x | x | | x | x | |
| 02.8 | 2.8 | 250 | 0.0675 | 269 | x | x | x | | x | x | |
| 003.* | 3 | 250 | 0.0593 | 200 | x | x | x | | x | x | |
| 03.2 | 3.2 | 250 | 0.0529 | 209 | x | x | x | | x | x | |
| 004.* | 4 | 250 | 0.0311 | 76.1 | x | x | x | | x | x | |
| 005.* | 5 | 250 | 0.0214 | 276 | x | x | x | | x | x | |
| 6.25* | 6.25 | 250 | 0.0154 | 388 | x | x | x | | x | x | |
| 06.3 | 6.3 | 250 | 0.0154 | 388 | x | x | x | | x | x | |
| 007.* | 7 | 250 | 0.0128 | 547 | x | x | x | | x | x | |
| 008.* | 8 | 250 | 0.0111 | 701 | x | x | x | | x | x | |
| 010.** | 10 | 250 | 0.0083 | 1285 | x | x | | | x | x | |
| 010.* | 10 | 32 | 0.0083 | 1285 | | | | x | | | |
| 012. | 12 | 32 | 0.0065 | 1200 | | | | x | | | |
| 015.** | 15 | 125 | 0.0050 | 2650 | | x | | x | x | x | |
| 015. | 15 | 32 | 0.0050 | 2650 | | | | x | | | |
| 020. | 20 | 32 | 0.0022 | 9560 | | | | x | | | |
| 025. | 25 | 32 | 0.0017 | 16500 | | | | x | | | |
| 030. | 30 | 32 | 0.0012 | 26900 | | | | x | | | |
| 030. | 30 | 32 | 0.0012 | 26900 | | | | x | | | |

* For 313series, these ratings available with an indicating option. Add the "ID" designation to the series number. i.e. 313.500ID.

** These 2 ratings are designed for special voltage requirement. For 10A, it is available as 250Vac rated and the part number is 0313010.MX250P; For 15A, it is available as 125Vac rated and the part number is 0315015.MX125P.

Temperature Re-rating Curve

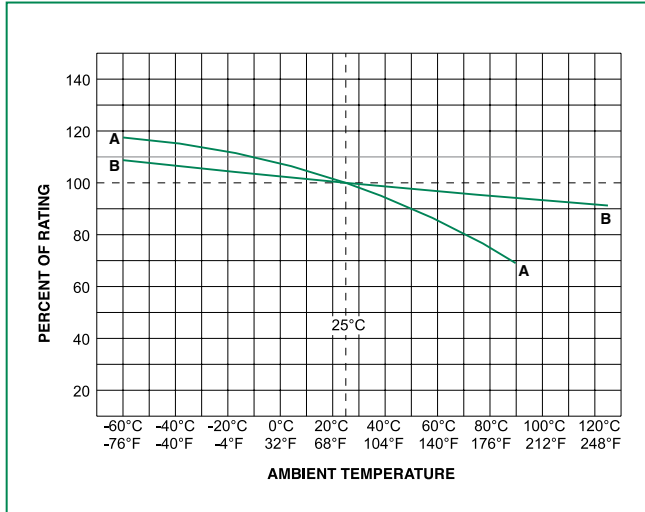

A - For 313/315 Series, from 10mA to 150mA

B - For all other ampere ratings of 313/315 series

Note:

Derating depicted in this curve is in addition to the standard derating of 25% for continuous operation.

Average Time Current Curves

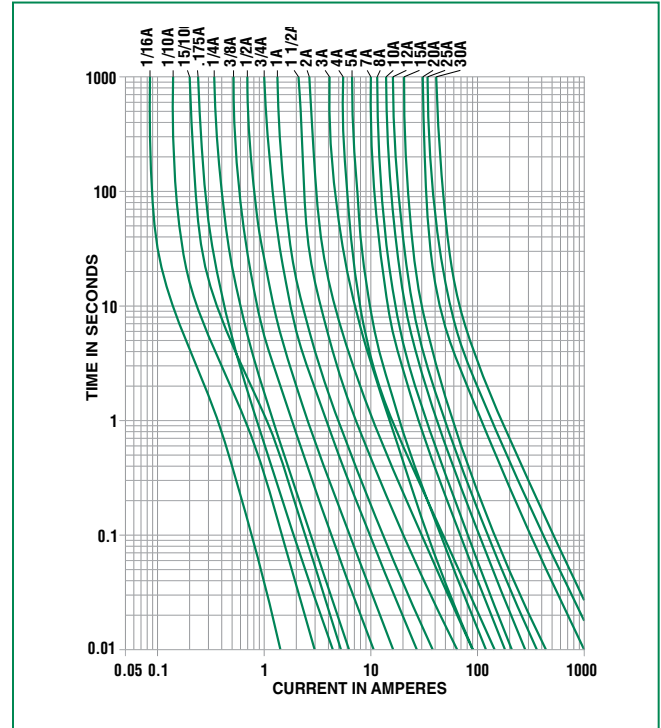

Soldering Parameters - Wave Soldering

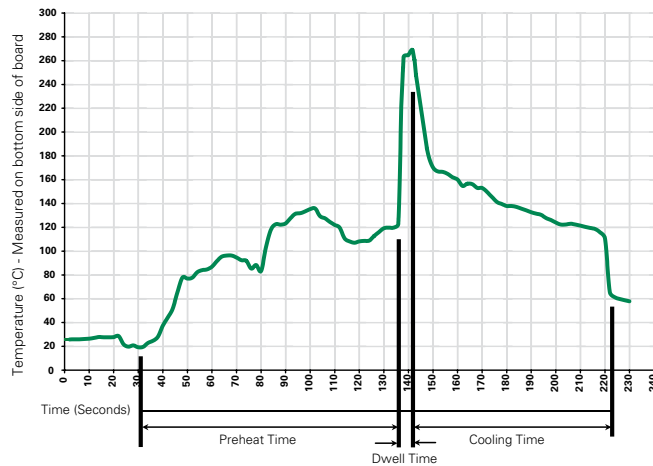

Recommended Process Parameters:

| Wave Parameter | Lead-Free Recommendation |
|---|--------------------------|
| Preheat: (Depends on Flux Activation Temperature) (Typical Industry Recommendation) | |
| Temperature Minimum: | 100°C |
| Temperature Maximum: | 150°C |
| Preheat Time: | 60-180 seconds |
| Solder Pot Temperature: | 260°C Maximum |
| Solder Dwell Time: | 2-5 seconds |

Recommended Hand-Solder Parameters:

Solder Iron Temperature: 350°C +/- 5°C
 Heating Time: 5 seconds max.

Note: These devices are not recommended for IR or Convection Reflow process.

Packaging

| Packaging Option | Packaging Specification | Quantity | Quantity & Packaging Code | Taping Width |
|-------------------|-------------------------|----------|---------------------------|--------------|
| 313 Series | | | | |
| Bulk | N/A | 1000 | MX | N/A |
| Bulk | N/A | 100 | HX | N/A |
| 315 Series | | | | |
| Bulk | N/A | 1000 | MX | N/A |
| Bulk | N/A | 100 | HX | N/A |
| Bulk | N/A | 1000 | MXB | N/A |

Product Characteristics

| | |
|--------------------------|---|
| Materials | Body: Glass Cap: Nickel-plated brass Leads: Tin-plated Copper |
| Terminal Strength | MIL-STD-202, Method 211, Test Condition A |
| Solderability | MIL-STD-202 method 208 |
| Product Marking | Cap1: Brand logo, current and voltage ratings Cap2: Series and agency approval marks |

| | |
|------------------------------|--|
| Operating Temperature | -55°C to +125°C |
| Thermal Shock | MIL-STD-202, Method 107, Test Condition B: (5 cycles -65°C to +125°C) |
| Vibration | MIL-STD-202, Method 201 |
| Humidity | MIL-STD-202, Method 103, Test Condition A: High RH (95%) and Elevated temperature (40°C) for 240 hours |
| Salt Spray | MIL-STD-202, Method 101, Test Condition B |

Dimensions

Measurements displayed in millimeters (inches)

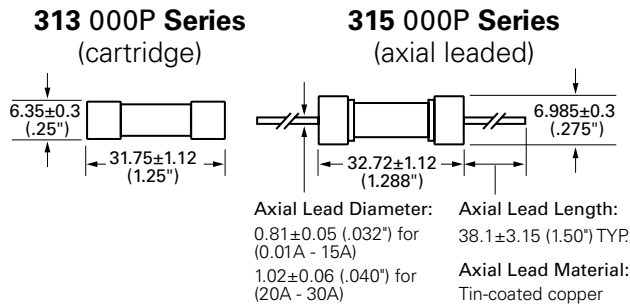

Part Numbering System

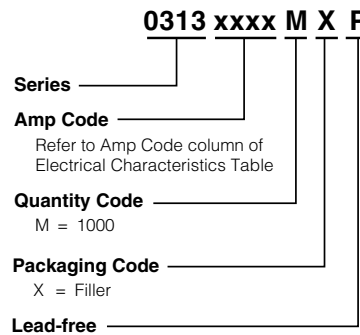

Recommended Accessories

| Accessory Type | Series | Description | Max Application Voltage | Max Application Amperage |
|----------------|------------------------|---|-------------------------|--------------------------|
| Holder | 155100 | Twist-Lock In-Line Fuseholder | 32 | 20 |
| | 342 | Traditional Panel Mount Fuseholder | 250 | 20 |
| | 346 | Panel Mount Flip-Top Shock-Safe Fuseholder | 250 | 15 |
| | 345 | Shock-Safe Fuseholder with PC Mount, Solder Mount and Panel Mount options | 250 | 16 |
| Block | 354 | Low Profile OMNI-BLOK® Fuse Block | 600 | 30 |
| | 359 | High Current Screw Terminal Fuse Block | | 30 |
| Clip | 122 | High Current Traditional PC Board Fuse Clip | 1000 | 30 |
| | 101 | Rivet/Eyelet Type Fuse Clip | 1000 | 15 |

Notes:
 1. Do not use in applications above rating.
 2. Please refer to fuseholder data sheet for specific re-rating information.
 3. Please contact factory for applications greater than the max voltage and amperage shown.

Disclaimer Notice - Information furnished is believed to be accurate and reliable. However, users should independently evaluate the suitability of and test each product selected for their own applications. Littelfuse products are not designed for, and may not be used in, all applications. Read complete Disclaimer Notice at www.littelfuse.com/disclaimer-electronics.