

MAPX	MODIFICATION	DATE

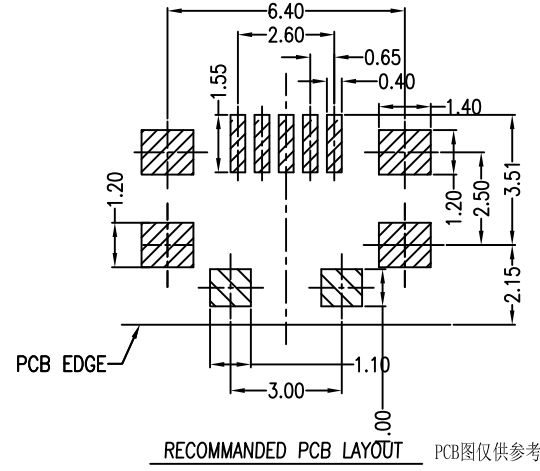
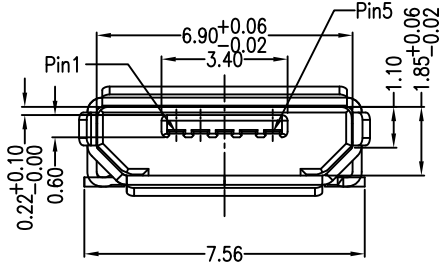
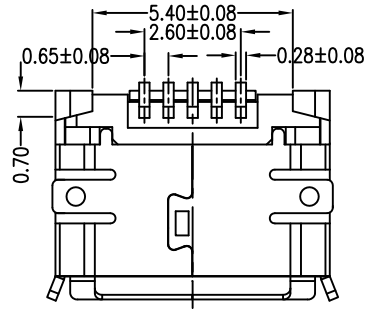
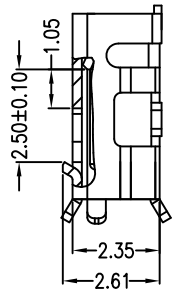
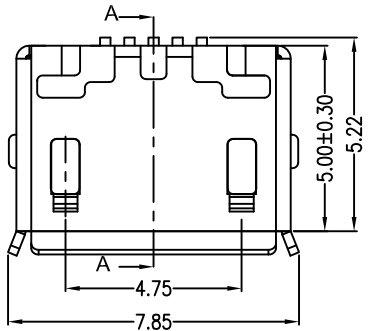
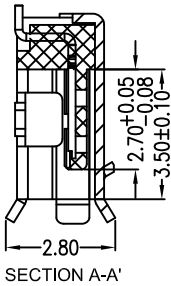
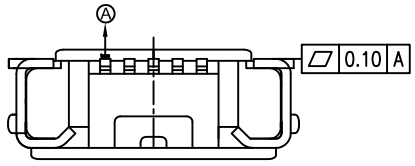

- Note:
- Material:
 - Housing: High temperature thermoplastic with g.f,UL94v-0
 - Contact: copper alloy,t=0.20mm
 - Shell: copper alloy,t=0.25mm
 - Specification:
 - Current rating:1.5PIN 1.8A Max/2,3,4PIN 1A Max.
 - Dielectric withstanding voltage: 100 V(ac) for 1 min.
 - Contact resistance: 30 mΩ Max.
 - Insulation resistance: 100 MΩ Min.
 - Total mating force: 3.57 Kgf Max.
 - Total unmating force: 1.0 Kgf Min
 - Temperature range: -30°C~80°C

产品图 PRODUCT CHART DWG		深圳市精拓金电子有限公司							
公差一览表 TOLERANCE UNLESS OTHERWISE		单位 UNITS	MM	制图 DRAWING	YANG	制图料号 PRODUCT PART NO.	920-D62A2021S10106		
X.	±0.30	X.	±5.°	比例 SCALE	1:1	审核 CHKD	郭志富	产品名称 PRODUCT NO.	MICRO/5S-B型四脚全贴有边 有孔无柱加长0.2
.X	±0.25	.X	±2.°	日期 DATE	2019. 11. 23	核准 APPD	黄国荣	角法 VIEW	版本 VER
.XX	±0.15	.XX	±1.°						AO
.XXX	±0.10	.XXX	±0.5°						