

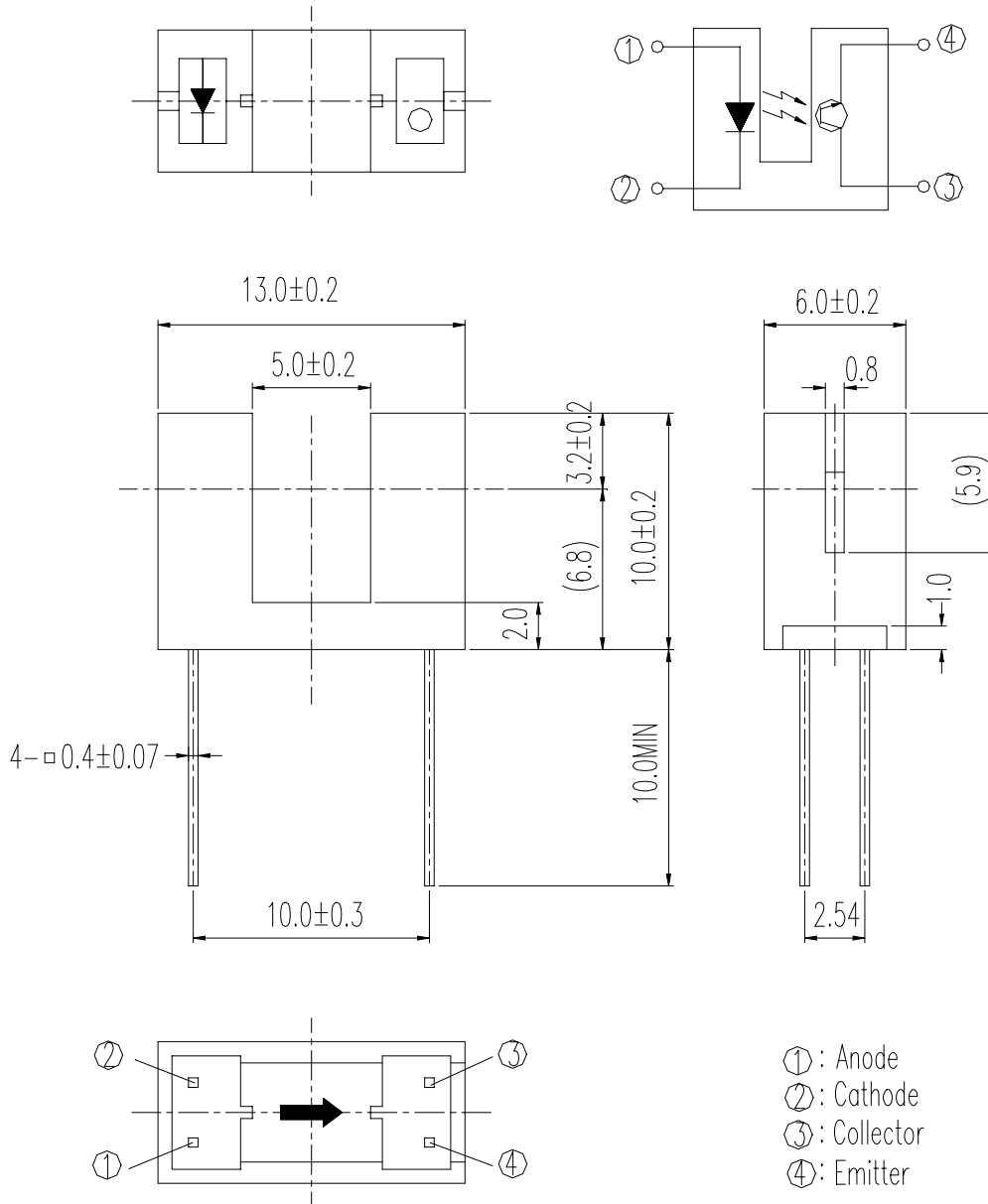

■ Package Dimensions :



SHENZHEN OFFICE:

TEL: 86-755-33590909 FAX: 86-755-33590908 E-mail: evlight@163.com



◎Notes :

- 1.All dimensions are in millimeter.
- 2.General Tolerance:± 0.2mm
- 3.Lead spacing is measured where the lead emerge from the package.
- 4.Above specification may be changed without notice. EVERLIGHT will reserve authority on material change for above specification.
- 5.These specification sheets include materials protected under copyright of EVERLIGHT corporation. Please don't reproduce or cause anyone to reproduce them without EVERLIGHT's consent.
- 6.When using this product , please observe the absolute maximum ratings and the instructions for use outlined in these specification sheets. EVERLIGHT assumes no responsibility for any damage resulting from use of the product which does not comply with the absolute maximum ratings and the instructions included in these specification sheets.

■ Descriptions:

The ITR9608 (Slot Optical Switch) is a gallium arsenide infrared emitting diode which is coupled with a silicon photo transistor in a plastic housing. The packaging system is designed to optimizes the mechanical resolution, coupling efficiency, and insulates ambient light. The slot in the housing a provides a means of interrupting the signal with printer, scanner, copier, or other opaque material, switching the output from an " ON" to" OFF" state.

■ Features:

- Wide gap between light emitter and detector(5.0mm)
- High sensing accuracy
- PWB mounting type package

■ Applications:

- Copier
- Printer
- Facsimile
- Ticket vending machine
- Opto-electronic switch



■ Absolute Maximum Ratings (Ta=25°C)

| Parameter | | Symbol | Ratings | Unit |
|---|---|------------------|---------|------|
| Input | Power Dissipation at(or below) 25°C Free Air Temperature | P _d | 75 | mW |
| | Reverse Voltage | V _R | 5 | V |
| | Forward Current | I _F | 50 | mA |
| | Peak Forward Current Pulse width ≤100μs, Duty cycle=1% | I _{FP} | 1 | A |
| Output | Collector Power Dissipation | P _C | 75 | mW |
| | Collector Current | I _C | 20 | mA |
| | Collector-Emitter Voltage | V _{CEO} | 30 | V |
| | Emitter-Collector Voltage | V _{ECO} | 5 | V |
| Operating Temperature | | Topr | -25~+85 | °C |
| Storage Temperature | | Tstg | -40~+85 | °C |
| Lead Soldering Temperature (1/16 inch from body for 5 seconds) | | Tsol | 260 | °C |

■ Electro-Optical Characteristics (Ta=25°C)

| Parameter | | Symbol | Min. | Typ. | Max. | Unit | Condition |
|-------------------------|------------------------|----------------------|------|------|------|------|--|
| Input | Forward Voltage | V _F | - | 1.2 | 1.5 | V | I _F =20mA |
| | Reverse Current | I _R | - | - | 10 | μA | V _R =5V |
| | Peak Wavelength | λ _p | - | 940 | - | nm | I _F =20mA |
| Output | Collector Dark Current | I _{CEO} | - | - | 100 | nA | V _{CE} =20V Ee=0mW/cm ² |
| Transfer Characteristic | C-E Saturation Voltage | V _{CE(sat)} | - | - | 0.4 | V | I _C =0.5mA Ee=10mW/cm ² |
| | Collector Current | I _{C(ON)} | 0.5 | - | - | mA | V _{CE} =5V I _F =20mA |
| | Rise time | t _r | - | 15 | - | μsec | V _{CE} =5V |
| | Fall time | t _f | - | 15 | - | μsec | I _C =1mA R _L =1KΩ |

MODEL NO: ITR9608

■ Typical Characteristics For IR

Fig. 1 Forward Current vs. Ambient Temperature

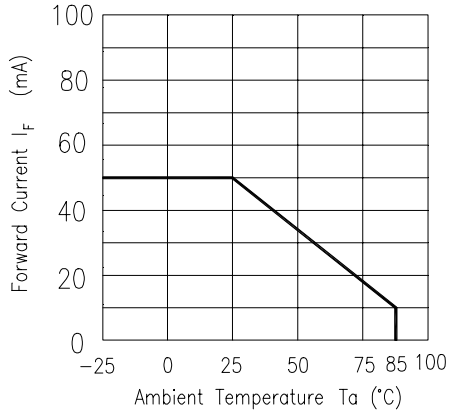

Fig. 2 Spectral Distribution

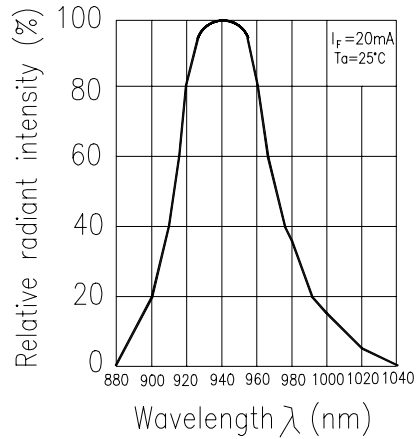

Fig. 3 Peak Emission Wavelength vs. Ambient Temperature

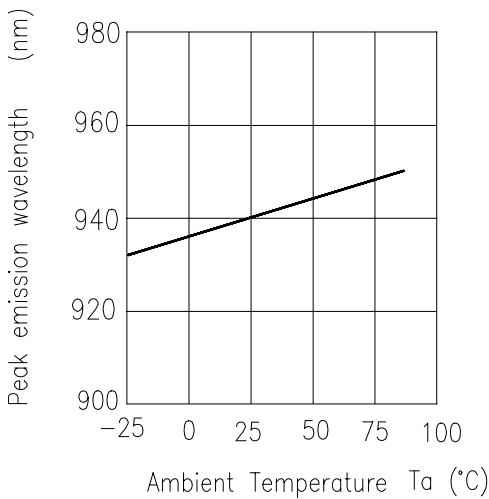

Fig. 4 Forward Current vs. Forward Voltage

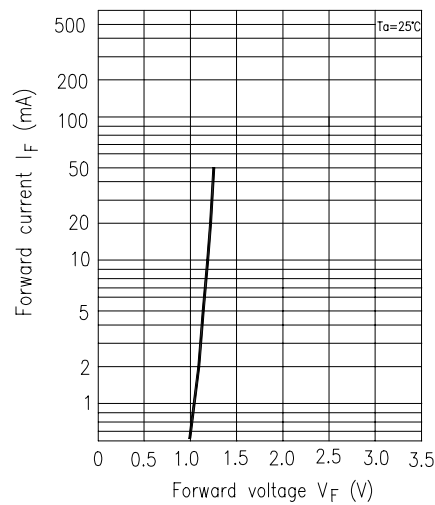

Fig. 5 Forward Voltage vs. Ambient Temperature

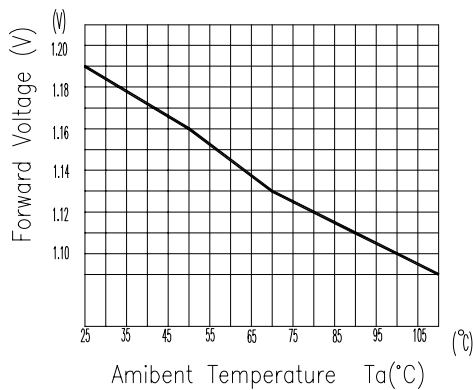
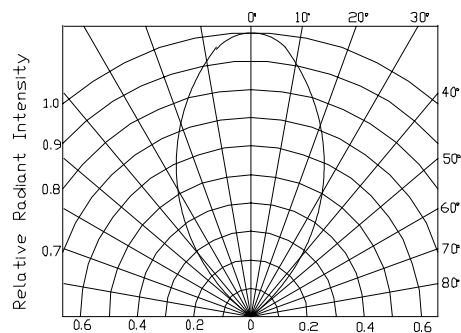
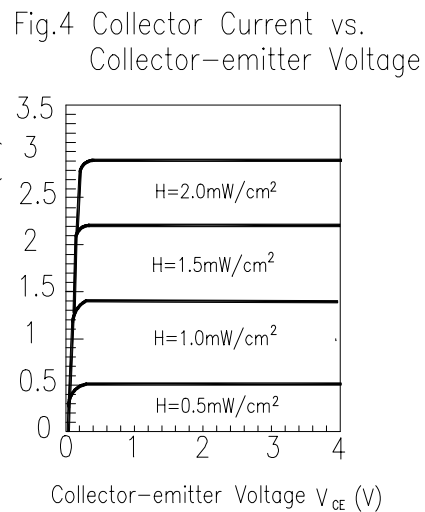
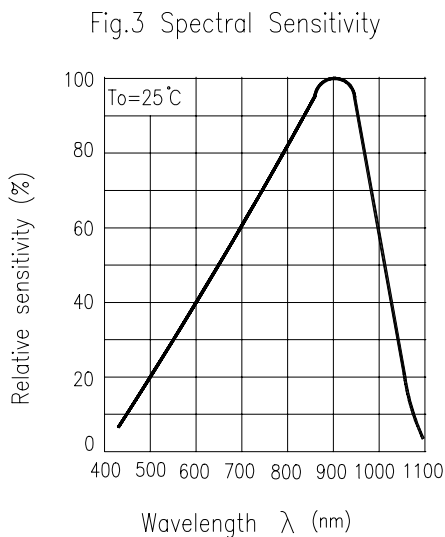
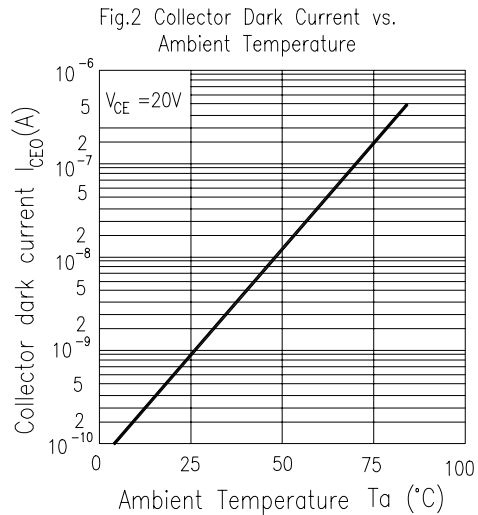
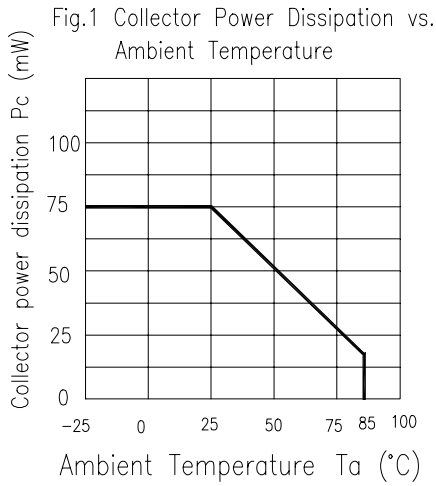

Fig. 6 Relative Radiant Intensity vs. Angular Displacement



MODEL NO: ITR9608

■ Typical Characteristics For PT



■ Typical Characteristics For ITR

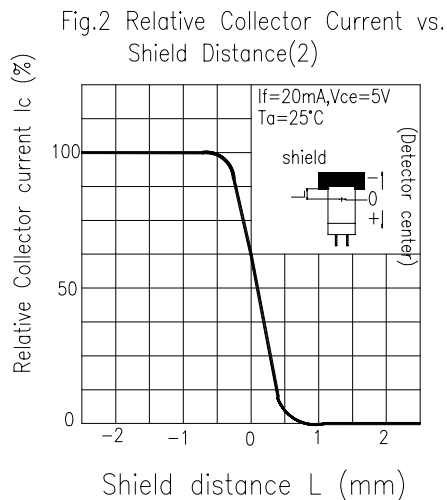
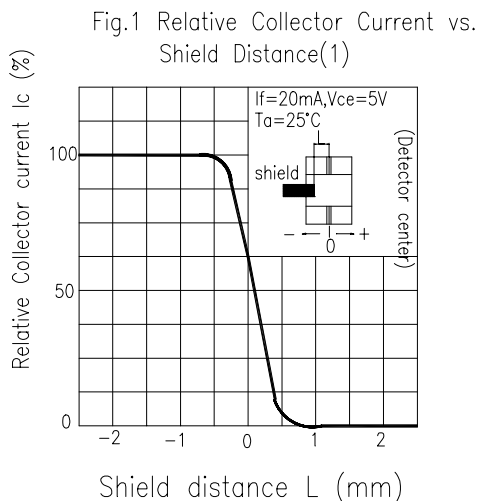



■ Reliability test item and condition

The reliability of products shall be satisfied with item listed below:

Confidence level :90%

LTPD:10%

| Parameter | Purpose & Condition | Failure Judgement Criteria | Samples(n) Defective(c) |
|--------------------------|---|---|----------------------------|
| Temperature Cycle | Evaluates product's ability to withstand exposure to high temperature, low temperature, and temperature variation between two limit temperature. Standard test Condition: $\begin{array}{cccc} 85^{\circ}\text{C} & \sim & 25^{\circ}\text{C} & \sim & -55^{\circ}\text{C} & \sim & 25^{\circ}\text{C} \\ \downarrow & & \downarrow & & \downarrow & & \downarrow \\ 30\text{min} & & 5\text{min} & & 30\text{min} & & 5\text{min} \end{array}$ 50 cycle | $I_R \geq U \times 2$ $I_{c(on)} \leq L \times 0.8$ $V_F \geq U \times 1.2$ U : Upper specification limit L : Lower specification limit | n =22 , c=0 |
| Thermal Shock | Evaluates product's ability to withstand rapid temperature change Standard test Condition: $\begin{array}{ccc} 85^{\circ}\text{C} & \sim & -55^{\circ}\text{C} \\ 5\text{min} & & 5\text{min} \end{array}$ 50cycle | | n =22 , c=0 |
| High Temperature Storage | Evaluates product's ability to withstand prolonged storage at high temperature Standard test Condition: Temperature : 100 °C Time : 1000hrs | | n =22 , c=0 |
| Low Temperature Storage | Evaluates product's ability to withstand prolonged storage at low temperature Standard test Condition: Temperature : -55 °C Time : 1000hrs | | n =22 , c=0 |



| Parameter | Purpose & Condition | Failure Judgement Criteria | Samples(n) Defective(c) |
|-----------------------------------|--|--|----------------------------|
| Operating Life Test | Evaluates product's endurance to prolonged electrical or temperature stresses. Standard test Condition: $V_{CE}=5V$ $I_F=20mA$ Time : 1000hrs | $I_R \geq U \times 2$ $I_{c(on)} \leq L \times 0.8$ $V_F \geq U \times 1.2$ U : Upper specification limit | n =22 , c=0 |
| High Temperature High Humidity | Evaluates product's ability to withstand prolonged storage at high temperature and high humidity. Standard test Condition: Temperature: 85°C Relative humidity:85% Time : 1000hrs | L : Lower specification limit | n =22 , c=0 |
| Soldering Heat | Evaluates product's ability to withstand soldering heat Standard test conditions Solder temperature : 260±5°C Solder time : 10 seconds | | n =22 , c=0 |

■Supplements

1.Parts

(1) Chip

| Type | Material | Peak Wavelength |
|------|----------|-----------------|
| IR | GaAs | 940 nm |
| PT | Silicon | 860 nm |

(2)Material

| Type | Lead frame | Wire | Part Package | Holder |
|----------|------------|------|--------------|--------|
| Material | SPCC | Gold | Epoxy | NYLON |



MODEL NO: ITR9608

■ Packing Specifications

1. Bag

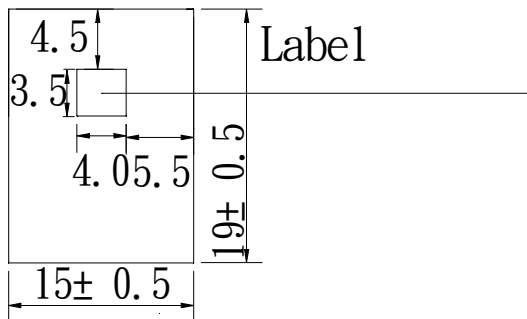

2. Box

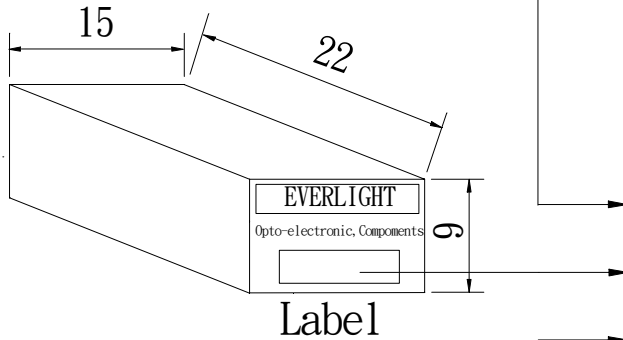

3. Carton

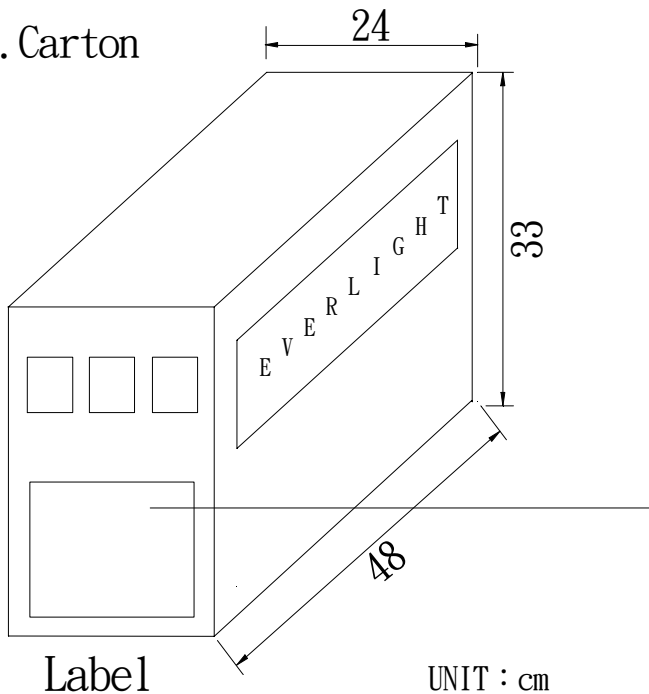

CPN : Customer's Product Number

P/N : Product Number

QTY : Packing Quantity

CAT : Ranks

HUE : Peak Wavelength

REF : Reference

LOT NO : Lot Number

MADE IN TAIWAN : Production place

■ Packing Quantity Specification

1.150Pcs/1Bag , 4Bags/1Box

2.10Boxes/1Carton