

● Description

The KT101X series consist of an infrared emitting diode, optically coupled to a phototransistor detector, and is incorporated in a 4 pin LSOP wide body package. It features a high current transfer ratio, low coupling capacitance and high isolation voltage.

● Schematic

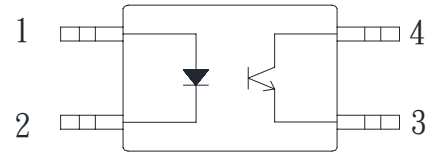

1. Anode
2. Cathode
3. Emitter
4. Collector

● Features

1. Halogen free
2. Pb free and RoHS compliant
3. Temperature range -55°C to 115°C
4. High isolation voltage 5000Vrms
5. Opaque type, SMD low profile 4 lead package
6. Current transfer ratio
(CTR : Min.50% at $I_F=5\text{mA}$ $V_{CE}=5\text{V}$)
7. 8mm outer creepage distance
8. DC input with transistor output
9. MSL class 1
10. Agency Approvals:
 - UL Approved (No. E169586): UL1577
 - c-UL Approved (No. E169586)
 - VDE Approved (No. 40031267): DIN EN60747-5-5
 - FIMKO Approved: EN60065, EN60950, EN60335, EN60601
 - CQC Approved: GB8898-2011, GB4943.1-2011

● Applications

- Hybrid substrates that require high density mounting
- Programmable controllers
- Switch mode power supplies
- Microprocessor system interface

● **Outside Dimension**

Unit : mm

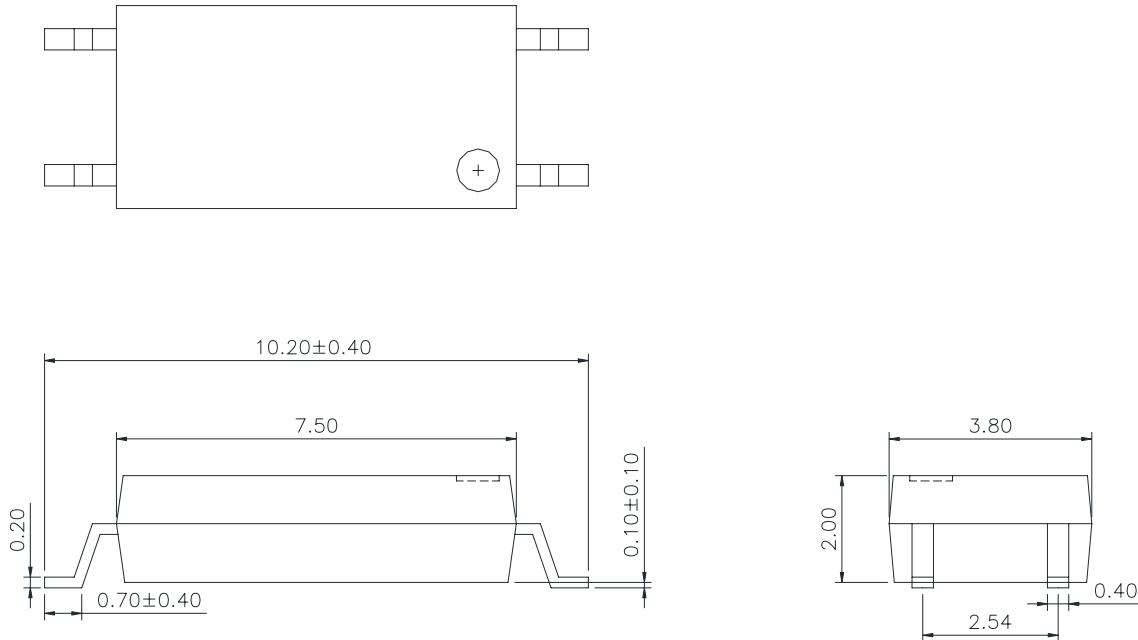

TOLERANCE : ± 0.2 mm

● **Device Marking**

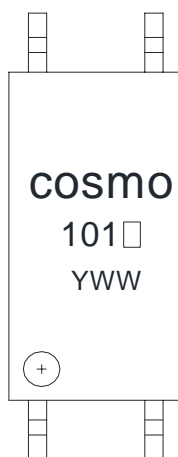

Notes:

cosmo

101 □

YWW

□: CTR rank

Y: Year code / WW: Week code



KT101X Series

4PIN LSOP PHOTOTRANSISTOR PHOTOCOUPLER

● Absolute Maximum Ratings

(Ta=25°C)

Parameter		Symbol	Rating	Unit
Input	Forward current	I_F	50	mA
	Peak forward current	I_{FP}	1	A
	Reverse voltage	V_R	6	V
	Power dissipation	P_D	100	mW
Output	Collector-Emitter voltage	V_{CEO}	80	V
	Emitter-Collector voltage	V_{ECO}	7	V
	Collector current	I_C	50	mA
	Collector power dissipation	P_C	150	mW
Total power dissipation		P_{tot}	250	mW
Isolation voltage 1 minute		V_{iso}	5000	V _{rms}
Operating temperature		T_{opr}	-55 to +115	°C
Storage temperature		T_{stg}	-55 to +125	°C
Soldering temperature 10 seconds		T_{sol}	260	°C

● Electro-optical Characteristics

(Ta=25°C)

Parameter		Symbol	Conditions	Min.	Typ.	Max.	Unit
Input	Forward voltage	V_F	$I_F=20mA$	-	1.2	1.4	V
	Reverse current	I_R	$V_R=4V$	-	-	10	uA
	Terminal capacitance	C_t	$V=0, f=1KHz$	-	30	250	pF
Output	Collector dark current	I_{CEO}	$V_{CE}=20V, I_F=0$	-	-	0.1	uA
	Collector-Emitter breakdown voltage	BV_{CEO}	$I_C=0.1mA, I_F=0$	80	-	-	V
	Emitter-Collector breakdown voltage	BV_{ECO}	$I_E=100uA, I_F=0$	7	-	-	V
Transfer characteristics	Current transfer ratio	CTR	$I_F=5mA, V_{CE}=5V$	50	-	600	%
			$I_F=1mA, V_{CE}=5V$	15	-	-	%
	Collector-emitter saturation voltage	$V_{CE(sat)}$	$I_F=10mA, I_C=1mA$	-	0.1	0.3	V
	Isolation resistance	R_{iso}	DC500V, 40 to 60%RH	5×10^{10}	10^{11}	-	Ω
	Floating capacitance	C_f	$V=0, f=1MHz$	-	0.6	1.0	pF
	Response time (Rise)	t_r	$V_{CC}=2V, I_C=2mA, R_L=100\Omega$	-	5	-	us
	Response time (Fall)	t_f		-	4	-	us

Classification table of current transfer ratio is shown below.

CTR Rank	CTR (%)
KT1015	50 TO 150
KT1016	100 TO 300
KT1017	80 TO 160
KT1018	130 TO 260
KT1019	200 TO 400
KT1010	50 TO 600

Fig.1 Current Transfer Ratio vs. Forward Current

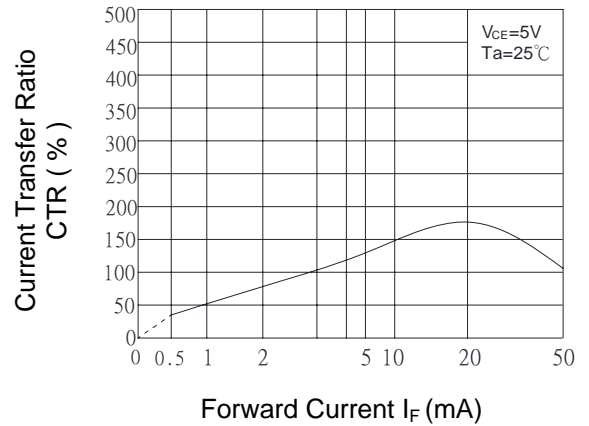

Fig.2 Collector Power Dissipation vs. Ambient Temperature

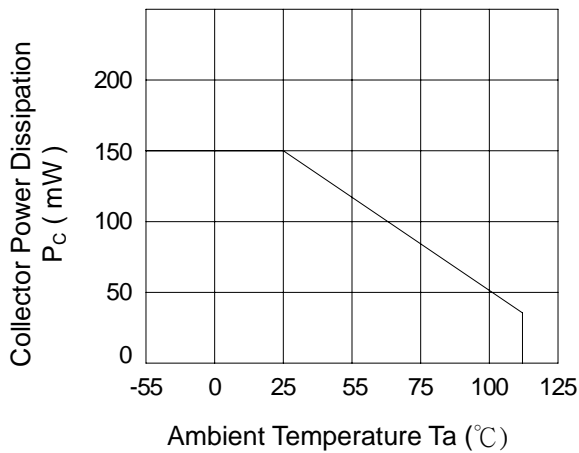

Fig.3 Collector Dark Current vs. Ambient Temperature

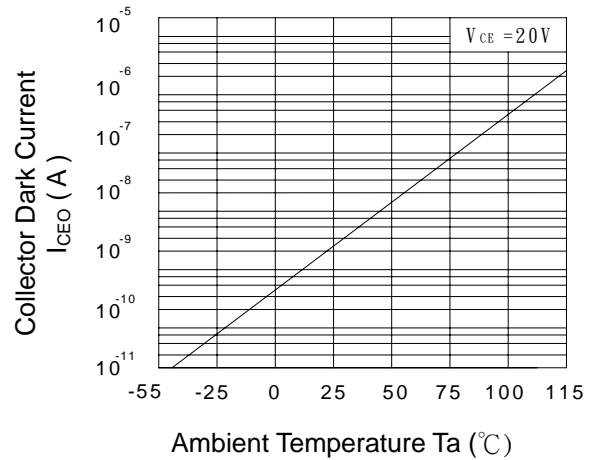

Fig.4 Forward Current vs. Ambient Temperature

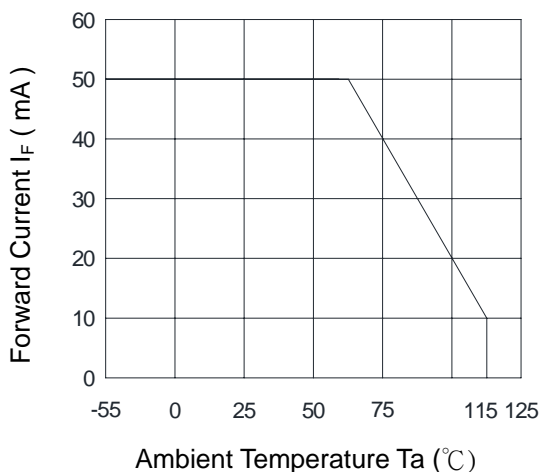

Fig.5 Forward Current vs. Forward Voltage

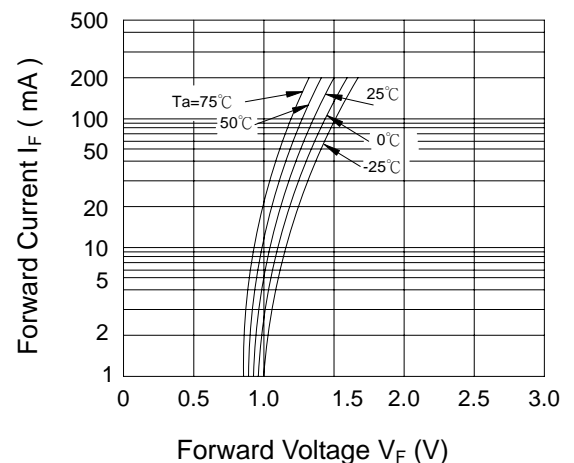

Fig.6 Collector Current vs. Collector-Emitter Voltage

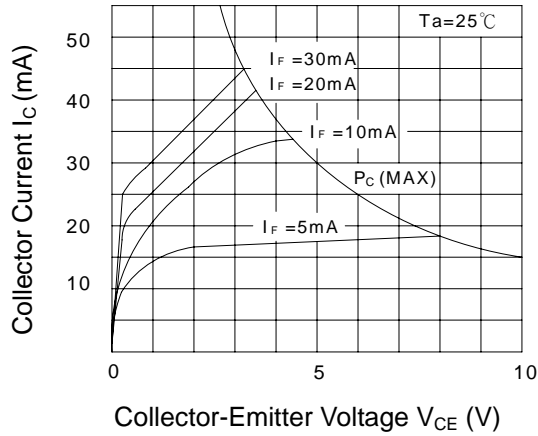

Fig.7 Relative Current Transfer Ratio vs. Ambient Temperature

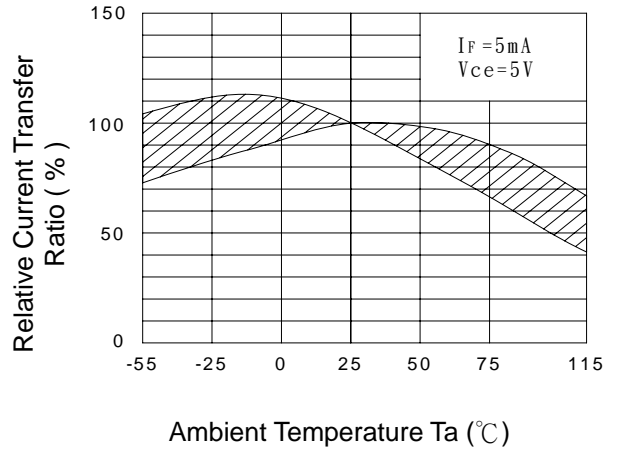

Fig.8 Collector-Emitter Saturation Voltage vs. Ambient Temperature

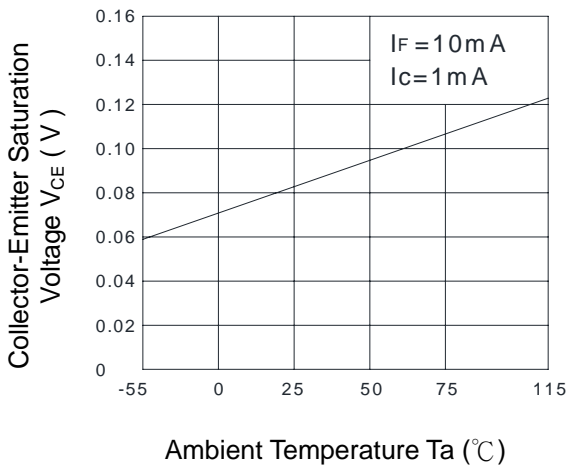

Fig.9 Collector-Emitter Saturation Voltage vs. Forward Current

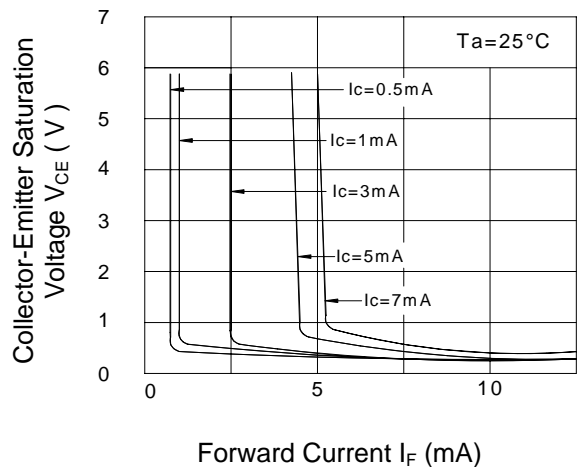

Fig.10 Response Time (Rise) vs. Load Resistance

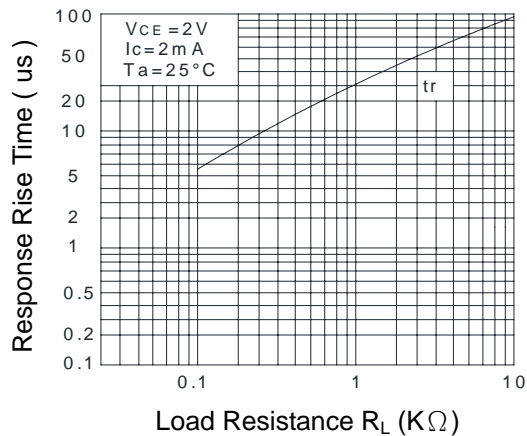
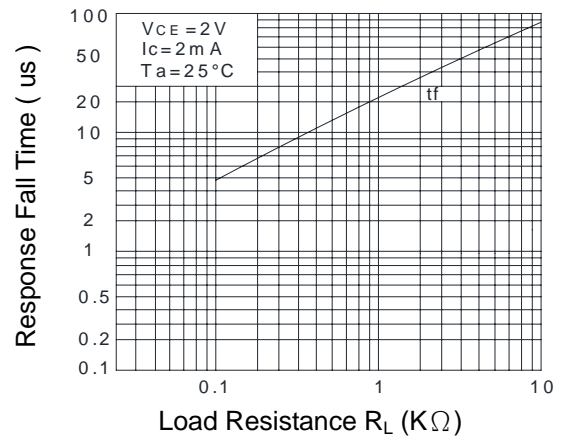
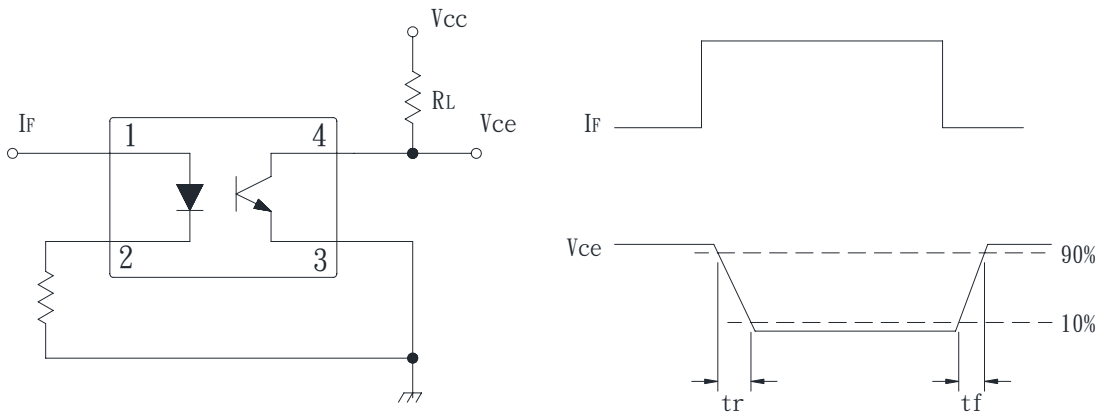

Fig.11 Response Time (Fall) vs. Load Resistance



● **Test Circuit for Response Time**



● Recommended Soldering Conditions

(a) Infrared reflow soldering :

- Peak reflow soldering : 260°C or below (package surface temperature)
- Time of peak reflow temperature : 10 sec
- Time of temperature higher than 230°C : 30-60 sec
- Time to preheat temperature from 180~190°C : 60-120 sec
- Time(s) of reflow : Two
- Flux : Rosin flux containing small amount of chlorine (The flux with a maximum chlorine content of 0.2 Wt% is recommended.)

Recommended Temperature Profile of Infrared Reflow

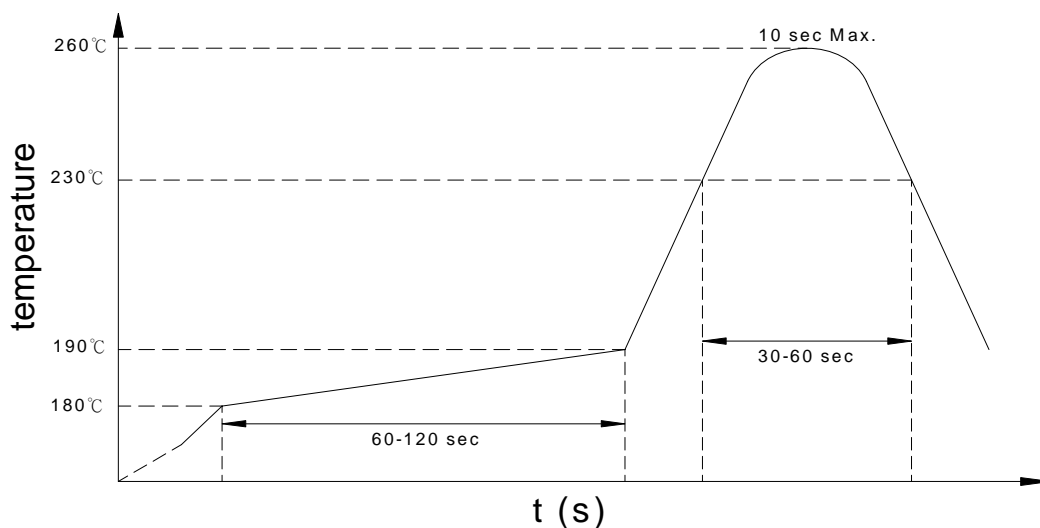

(b) Wave soldering :

- Temperature : 260°C or below (molten solder temperature)
- Time : 10 seconds or less
- Preheating conditions : 120°C or below (package surface temperature)
- Time(s) of reflow : One
- Flux : Rosin flux containing small amount of chlorine (The flux with a maximum chlorine content of 0.2 Wt% is recommended.)

(c) Cautions :

- Fluxes : Avoid removing the residual flux with freon-based and chlorine-based cleaning solvent.
- Avoid shorting between portion of frame and leads.

- **Numbering System**

KT101 Y (Z)

Notes:

KT101 = Part No.

Y = CTR rank option (5 ~ 10)

Z = Tape and reel option (TLD · TRU)

Option	Description	Packing quantity
TLD	TLD tape & reel option	3000 units per reel
TRU	TRU tape & reel option	3000 units per reel

- **Recommended Pad Layout for Surface Mount Lead Form**

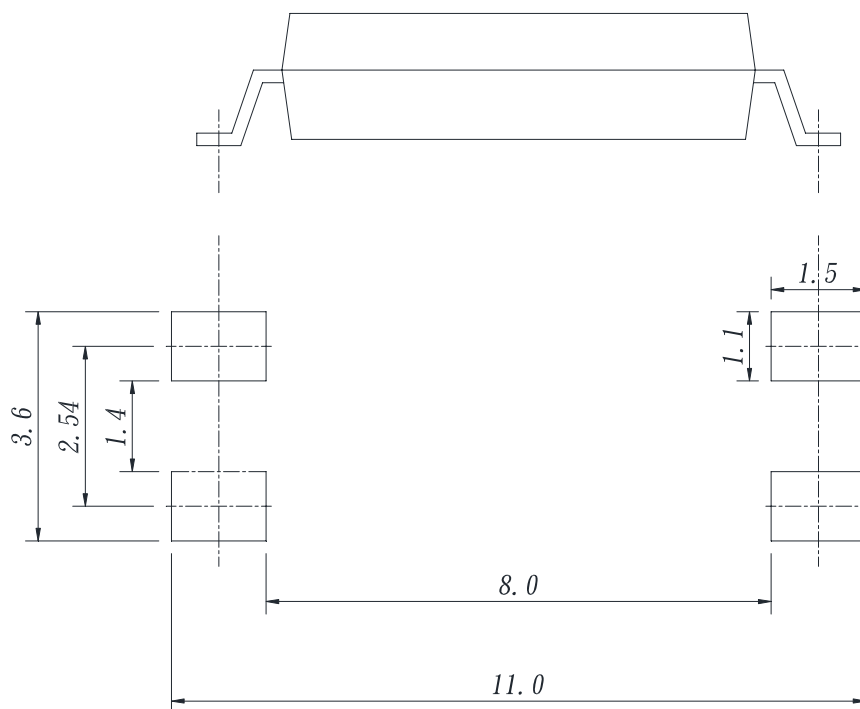

Unit : mm

● 4-pin LSOP Carrier Tape & Reel

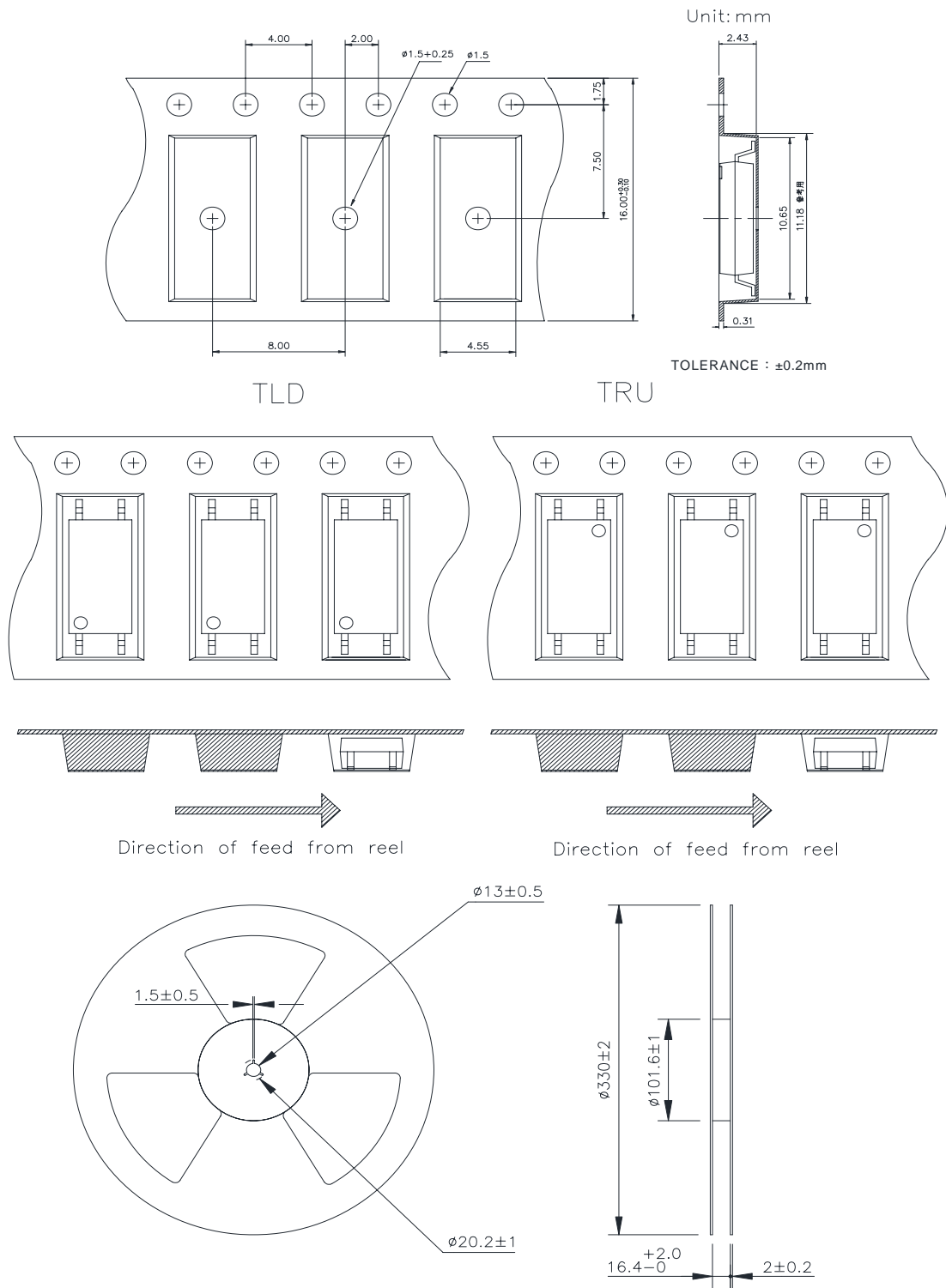



KT101X Series

4PIN LSOP PHOTOTRANSISTOR PHOTOCOUPLER

● Application Notice

The content of datasheet is the guidance for product use only. cosmo takes no responsibility to the accuracy of the information provided here. For continuously improving all of products, including quality, reliability, function...etc., cosmo reserves the right to change the specification, characteristics, data, materials, and structure of products without notice. Please contact with cosmo to obtain the latest specification.

It would be required to comply with the absolute maximum ratings listed in the specification. cosmo has no liability and responsibility to the damage caused by improper use of the products.

cosmo products are intended to be designed for use in general electronics application list below:

- a. Personal computer
- b. OA machine
- c. Audio / Video
- d. Instrumentation
- e. Electrical application
- f. Measurement equipment
- g. Consumer electronics
- h. Telecommunication

cosmo devices shall not be used or related with equipment requiring higher level of quality / reliability, or malfunction, or failure which may cause loss of human life, bodily injury, includes, without limitation:

- a. Medical and other life supporting equipments
- b. Space application
- c. Telecommunication equipment (trunk lines)
- d. Nuclear power control
- e. Equipment used for automotive vehicles, trains, ships...etc.

This publication is the property of cosmo. No part of this publication may be reproduced or copied in any form or any means electronically or mechanically for any purpose, in whole or in part without any written permission expressed from cosmo.