

# Amass®

艾迈斯电子

2014

## Test & Measurement

AMASS模型连接器，全球顶级模型连接器制造商  
AMASS R/C connectors, world top brand  
网址(WEB): [www.amassmodel.com](http://www.amassmodel.com)



- Test Probe & Clip  
测试钩、针、探笔
- Banana Plug  
香蕉插头
- Connecting Plug  
短路插及转换
- Panel Socket  
面板插座
- Binding Post  
接线柱
- Test Lead  
测试导线
- BNC Adapter & Breakouts  
BNC 转换
- Crocodile Clip  
鳄鱼夹
- Test Kits  
测试组套



# Amass®

常州市艾迈斯电子有限公司  
CHANGZHOU AMASS ELECTRONICS CO.,LTD.

地址：江苏省常州市武进区礼嘉

Add: Lijia Town, Wujin Dis.Changzhou City,  
Jiangsu Pro.China.

邮编(Postal Code): 213176

全国免费热线): 400-0772998

电话(Tel): 86-519-86731695

传真(Fax): 86-519-86735861

邮件(E-mail): [hzy@china-amass.com](mailto:hzy@china-amass.com)

常州市艾迈斯电子有限公司  
CHANGZHOU AMASS ELECTRONICS CO.,LTD.



# 常州市艾迈斯电子有限公司 CHANGZHOU AMASS ELECTRONICS CO.,LTD.

- P01-02 企业简介 (Enterprise Introduction)
- P03-04 生产与质量 (Production and Quality)
- P05-06 营销与服务 (Marketing and Service)
- P07-08 资质与荣誉 (Honors and Credits)
- P09-48 产 品 (Products)



## 企 业 介 绍

我司是目前国内香蕉插头品种最全、产量最多的测试接插件厂家。公司拥有近18年的测试类接插件的生产经验,年产各类接插件数超亿。产品包括测试(钩、探针、探笔),香蕉插头,测试导线,面板插座及接线柱,鳄鱼夹等9大类近300余款产品,广泛应用于教学仪器(普教、高教),电力电工测试仪器,汽车测试仪器,医疗仪器等六大领域。

截止2014年底,公司占地面积17亩,厂房面积近20000平方米,员工168名。公司通过了ISO9001:2008认证,产品符合欧盟RoHS和Reach认证。拥有独立的研发团队及产品实验室,自主研发了多款与德国技术同步的测试类配件产品。稳定的产品质量和超高的性价比,为我们赢得了诸如清华科教、北京博电、美国Fluke,美国MAC TOOL等国内外近180家的上述六大领域厂家客户。目前我司产品65%以上出口,远销全球63个国家与地区,服务于全球近380家企业。

## Enterprise Introduction

AMASS has the most complete products line about the test accessories.Meantime we are the largest manufacturer about the banana plug in China.Our company has 18 years of production experience in Test Accessroies.Now we have more than 300 kinds of products in 9 parts related to Test clip(Probe).Banana plug,Test lead,Panel socket&Binding post ,Crocodile clip and so on.These products are widely used in educational instrument,electrical instrument,auto test, medical instrument etc.

Until 2014,our company covers an aera of 17acres,plant area of 20000 square meters,168 employees. We have passed ISO9001:2008 certification and products comply with EU RoHS and Reach certification.Now we have independent R&D dept. and develop a variety of test accessories which same as the recent German technology.Based on the stable quality and high cost performance we have won nearly 180 manufacturers in above zone such as QINGHUA, PONOVO,FLUKE,MAC TOOL.At present,our products are exported to 63 countries and regions around the world,in the service of nearly 380 companies.



# 生产·质量 Production & Quality

专注细节彰显用心

品质如命铸就未来

## 生产过程控制

### Production Process Control

艾迈斯在整个生产过程中,严格执行“ISO9001国际质量管理体系”的标准要求,秉承“指令清晰,方法指导,过程控制,成果导向,持之以恒,触摸未来”的执行理念,艾迈斯于2011年11月通过了GB/T9001-2008/ISO9001:2008标准的国际质量管理体系认证。

Amass strictly implements the standards of "ISO9001 Quality Management System" throughout the production process

We got through the GB/T9001-2008/ISO9001:2008 international quality management system standard certification in November 2011



# 质量检测控制 Quality Detection & Controlling

采用与德国同步的技术,符合欧盟环保要求的原材料,国内领先的工艺,严格的质量管控,为客户提供稳定、安全、性价比最优并符合国际市场需求的产品。

从来料、加工、生产到出厂,依靠各种检测设备,按标准的质量管理体系,在从进到的过程中,对产品的物理性能,电器性能做控制,同时,对特殊的产品要求,如ROHS,REACH,CE,UL等定期委托第三方进行检验,确保产品的质量可靠,稳定。

We provide customers with stable, secure and competitive products according to the marketing demand by the synchronizing technology with German, by the raw materials confirming to EU environmental requirements, by the leading processing technique and the strict quality control.

Each product would be tested by a variety of checkout equipments according to the standard of quality management system in the whole manufacturing process from the purchasing of raw material to the delivery. So we can easily control the products of physical and electrical properties ,meanwhile we also regularly entrust a third party to do inspection for different standards ,such as ROHS, REACH, CE, UL etc. to ensure the consistent and reliable quality of products.

## 艾迈斯电子有限公司质量检测流程 Quality Inspection Process in Amass Electronics Co., Ltd

完善的质检流程铸就高品质的产品

High-quality Products Come from the Complete Quality Inspection Process

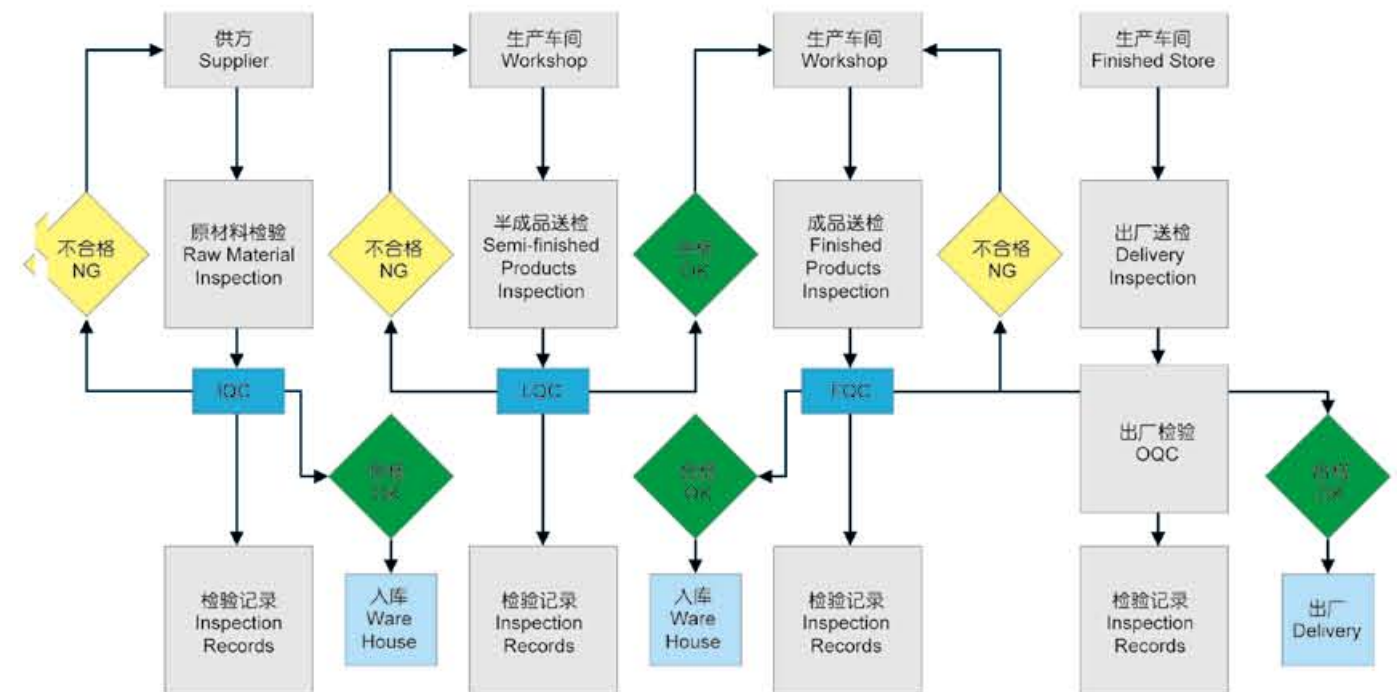



# 营销·服务

## Marketing & Services

您的满意 我的享受 牢记主动 拥抱未来

日益壮大的销售网络

The growing sales network

截止2013年底艾迈斯在全国设有近15个经销商网点,并以平均每年3个的速度在不断向全国各重点城市发展。如您希望成为其中的一员,欢迎致电: 4000-772-998

By the end of 2013, Amass has already cooperated with 15 retailers and each year we will have at least three new distributors in the main cities of China. If you want to be one of them, please call 4000-772-998

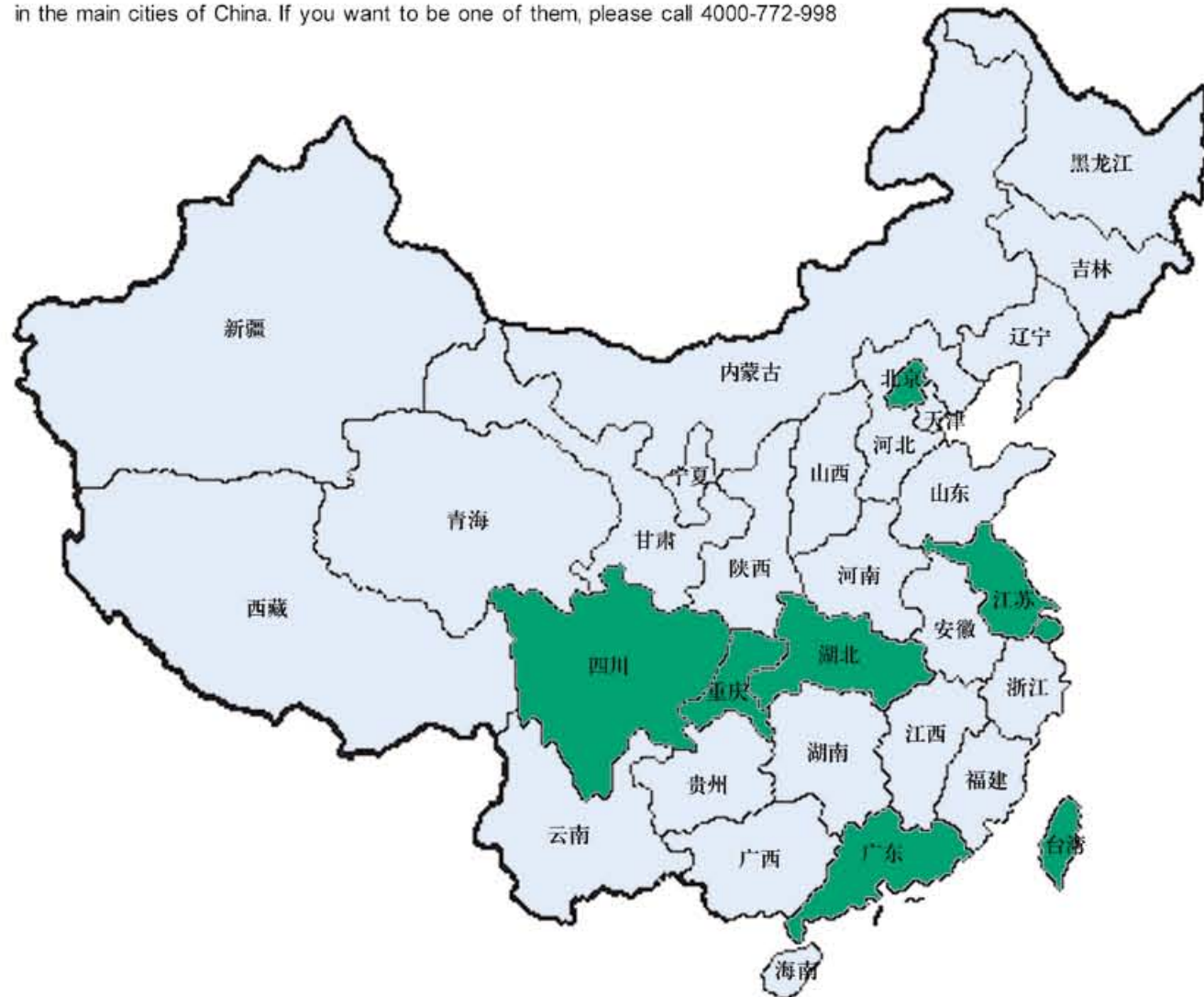

在推进国内销售网点的同时,艾迈斯也在不断发展覆盖全球的销售网络,目前我司已在英国、德国、意大利、波兰、土耳其、捷克、俄罗斯、阿联酋、泰国、越南、美国、巴西设有经销商。并以每年至少2个的速度不断扩张,如您希望成为其中的一员,欢迎来邮:

[hzy@china-amass.com](mailto:hzy@china-amass.com)

Amass not only promotes domestic sales outlets, but also develops worldwide sales network. Now we already have distributors in the UK, Germany, Italy, Poland, Turkey, Russia, UAE, Thailand, Vietnam, the United States, Brazil, etc. And every year at least two new dealers join us. If you want to be one of them, welcome to mail to

[hzy@china-amass.com](mailto:hzy@china-amass.com)



# 资质·荣誉

## Honors and Credits



### RoHS & Reach Certification证书



### How to order ?

Item No. explanation:

Examples: The catalogue offers the following

4mm banana plug, colors:

Item No.: 25.413.\*

If you want to order the red one, your order should be 25.413.1

4mm test lead, colors:

Length:

Item No.: 22.310. .\*

If you want to order the red one, L: 50CM, your order should be 22.310.050.1

### 如何订购?

型号解释:

范例1 样本中产品描述如下:

4mm香蕉插头, 型号25.413.\* 颜色:

如果你要订购该款红色的产品, 那么型号就是25.413.1

范例2: 4mm的测试导线, 型号22.310. .\*

颜色: 长度:

如果你要订购该款红色的线长为50cm的产品, 型号就是22.310.050.1





# 测试钩(针、探笔) TEST PROBE & CLIP

CAT等级值知多少

## 1. 什么是CAT等级

根据国际电子电工委员会IEC1010-1的定义,我们把电工工作的区域分为四个等级,分别称作CAT I, CAT II, CAT III和CAT IV。CAT等级是向下单向兼容的,也就是说,一款CAT IV的产品在CAT I,CAT II和CAT III下使用是完全安全的,但是一款CAT I的产品在CAT II,CAT III,CAT IV的环境下使用就不保证安全了。

## 2. CAT等级对用户意味着什么

CAT等级意味着对客户的人身安全承诺它不仅是的耐高压! CAT等级严格规定了电气工作人员在不同级别的电气环境中可能遇到的电气设备的类型以及在这样的区域中工作所使用的测量工具必须要遵循的安全标准。对于测试探针、探笔、香蕉插头、插座、测试导线、鳄鱼夹等来说,他们所标注的CAT等级表明了他们各自所归属的最高的“安全区域”,CAT后面的电压数值则表示了他们能够受到电压冲击的上限。例如一个CAT III 600V的香蕉插头,表示这样一个香蕉插头可以在CAT I, II和III区域安全使用,在这三个区域里如果表受到最高600V的电压冲击,表不会对人体安全产生威胁,但是这款香蕉插头在CAT IV域使用的时候,或者说受到700V的高压冲击的时候,就不能保证同样的安全了。CAT等级是向下单向兼容的,也就是说,一款CAT IV的产品在CAT I,CAT II和CAT III下使用是完全安全的,但是一款CAT I的产品在CAT I,CAT III,CAT IV的环境下使用就不保证安全了,可能发生漏电、燃烧威胁到你的安全。

## 3. AMASS的产品是怎么做的

AMASS的有CE认证的测试探针、探笔、香蕉插头、插座、测试导线、鳄鱼夹等产品都在规格书上标称了它的CAT等级和耐压值,并且整个产品的材质、机械性能、耐压设计都严格遵守CAT等级的要求。AMASS的产品经过第三方的安全测试,保证符合这个标称,100%保证在标称的CAT环境下使用安全性,100%保证能够承受所标称的高压冲击,且不会对人体产生任何伤害。

## 4. 你以后该怎么做

请了解并熟悉你的电气工作环境所属的CAT安全等级和耐压等级,并选择与其CAT等级和耐压等级对应的AMASS的产品。

CAT定义如下图:

IEC 61010-1 标准规定的测量类别



CAT I	测量不直接连接到电网电源的电路	加电池等
CAT II	测量直接连接到低电压电网电源的电路	测试通过电源插座供电的家电、办公和实验室设备
CAT III	测量建筑物内的电气配电设施	固定用电设备, 配电网子, 固定连接到配电网的设备
CAT IV	测量低电压配电设施的电源	电表, 电网终端, 主要的过压保护装置

对于测量和测试仪器而言,CE声明证实,其符合欧洲(低电压指令和EMC指令)法规。CE声明是产品进入欧洲国家的前提条件。遵守通过实施以下标准来证实: IEC61010-1 (国际), EN 61010-1(德国)(VDE分类 VDE 0411-1)。测量、检测和实验室使用的电气设备的安规认证在这些标准中有详细的描述,在1990年IEC的标准是第一个颁布的。

经过多年来的修改和完善(A1 1992, A2 1995),多数自前的修订版(所谓第二版)于2001年出版发行,上述标准被收录到德国版: EN 61010-1 标准的第二次发行之中,目前可在标准网电2002。

## • CAT 0,CATI,CATII,CATIII安全级别的含义:

- 注意, 测量设备的绝缘等级如1000V CATII, 600V CATII这些安全指标是IEEE非强制的要求, 可以由第三方自行或安全机构进行独立测试标定, 因此, 在测试时注意安全级别和量程范围是否相符, 否则会造成安全隐患! 以下是安全绝缘的分类, 必须提供相应的电压安全等级!

- 0类器具: 只靠基本绝缘提供防触电保护
- I类器具: 依靠基本绝缘+接地提供防触电保护
- II类器具: 依靠双重绝缘或加强绝缘提供防触电保护
- III类器具: 依靠安全特低电压提供防触电保护
- II类结构: 器具的部分结构属于II类
- III类结构: 器具的部分结构属于III类

Amass®

# 测试钩(针、探笔) Test Probe & Clip

20.132.\*

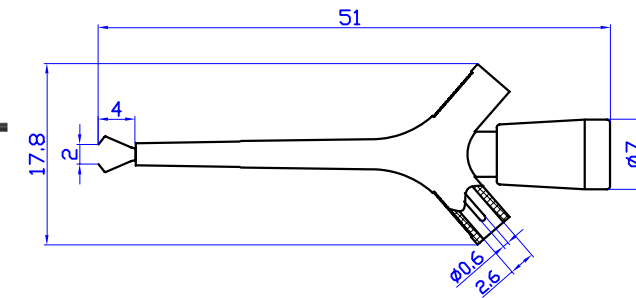

**材质**  
塑壳: PA  
主体: 铜  
表面: 镀金  
电气性能: 30Vac-60Vdc/Max.2A

**Material**  
Insulator: PA  
Body: Brass  
Surface: Gold plated  
**Rated voltage/current:**  
30Vac-60Vdc/Max.2A

### Feature

Mini test clip with pin connection. Specially for the thin wires and small terminals.



20.135.\*

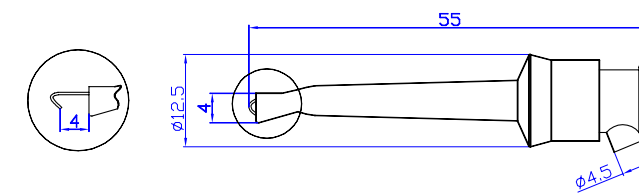

**材质**  
塑壳: PA  
主体: 铜  
表面: 镀金  
电气性能: 30Vac-60Vdc/Max.10A

**Material**  
Insulator: PA  
Body: Brass  
**Rated voltage/current:**  
30Vac-60Vdc/Max.10A

### Feature

Mini test clip with solder connection. Press with the good feeling and contact hook for wires up easily.



20.155.\*

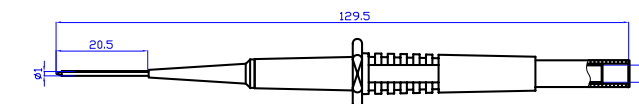

**材质**  
塑壳: PA  
主体: 铜和不锈钢  
电气性能: CATII 600V/Max.1A

**Material**  
Insulator: PA  
Body: Stainless steel & Brass  
**Rated voltage/current:**  
CATII 600V/Max.1A

### Feature

Safety test probe with 4mm socket connection. Sharp stainless steel needle.



20.156.\*

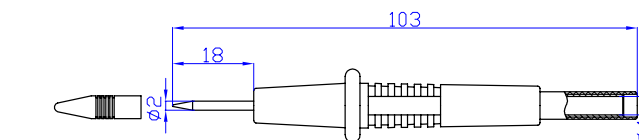
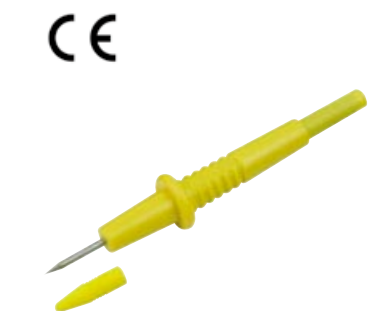

**材质**  
塑壳: PA  
主体: 铜和不锈钢  
电气性能: CATII 1000V/Max.10A

**Material**  
Insulator: PA  
Body: Stainless steel & Brass  
**Rated voltage/current:**  
CATII 1000V/Max.10A

### Feature

Safety test probe with 4mm socket connection. Sharp stainless steel tip with the perfectly protective cap.



20.157. \*

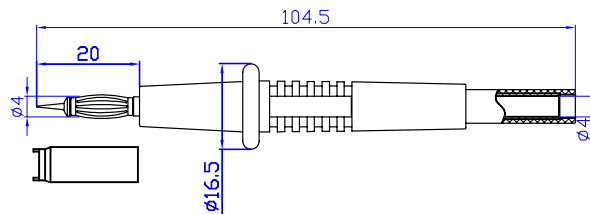

**Feature**

Safety test probe with 4mm socket connection. Spring-loaded tip with the protective cap.



**材质**  
 塑壳:PA  
 主体:铜  
 弹片:镀铜  
 表面:镀镍  
 电气性能 :CATII 1000V/Max.32A

**Material**  
 Insulator:PA  
 Body:Brass  
 Spring:Beryllium copper  
 Surface:Nickel plated  
**Rated voltage/current:**  
 CATII 1000V/Max.32A

20.160. \*

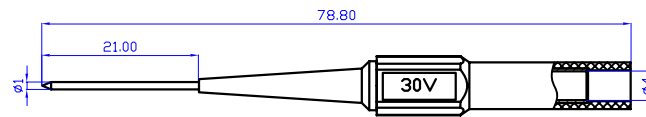

**Feature**

Safety test probe with 4mm socket connection. Sharp stainless steel needle.



**材质**  
 塑壳:PA  
 主体:不锈钢和铜  
 电气性能 :30Vac-60Vdc/Max.1A

**Material**  
 Insulator:PA  
 Body:Stainless steel & Brass  
**Rated voltage/current:**  
 30Vac-60Vdc/Max.1A

20.161. \*

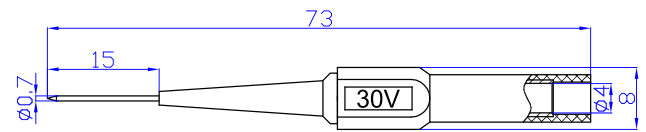

**Feature**

Safety test probe with 4mm socket connection. Sharp stainless steel needle.



**材质**  
 塑壳:PA  
 主体:不锈钢和铜  
 电气性能 :30Vac-60Vdc/Max.1A

**Material**  
 Insulator:PA  
 Body:Stainless steel & Brass  
**Rated voltage/current:**  
 30Vac-60Vdc/Max.1A

20.162. \*

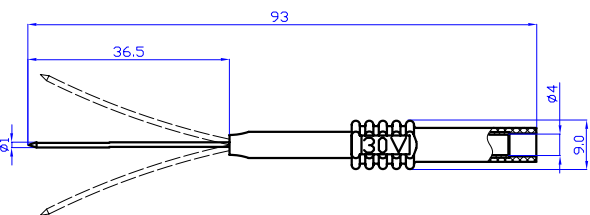

**Feature**

Safety test clip with 4mm socket connection. Long sharp stainless steel tip and flexible spring with the silicone tube can meet kinds of your request.



**材质**  
 塑壳:PA  
 主体:不锈钢和铜  
 电气性能 :30Vac-60Vdc/Max.10A

**Material**  
 Insulator:PA  
 Body:Stainless steel & Brass  
**Rated voltage/current:**  
 30Vac-60Vdc/Max.10A

20.163. \*

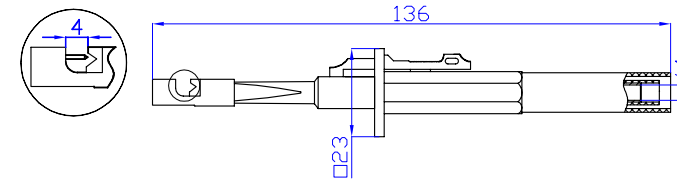

**Feature**

Safety test probe with 4mm socket connection. Stainless steel tip can connect with the wire without cutting it.



**材质**  
 塑壳:PA  
 主体:不锈钢和铜  
 电气性能 :CATIII 1000V/Max.10A

**Material**  
 Insulator:PA  
 Body:Stainless steel & Brass  
**Rated voltage/current:**  
 CATIII 1000V/Max.10A

20.164. \*

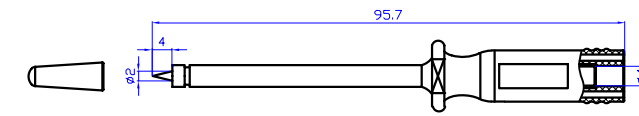

**Feature**

Safety test probe with 4mm socket connection. Sharp stainless steel tip with the protective cap.



**材质**  
 塑壳:PA  
 主体:不锈钢和铜  
 电气性能 :CATIII 1000V/Max.10A

**Material**  
 Insulator:PA  
 Body:Stainless steel & Brass  
**Rated voltage/current:**  
 CATIII 1000V/Max.10A

20.168. \*

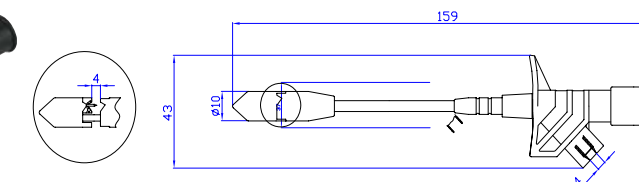

**Feature**

Safety test probe with 4mm socket connection. Stainless steel tip can connect with the wire without cutting it.



**材质**  
 塑壳:PA  
 主体:铜和不锈钢  
 表面:镀镍  
 电气性能 :CATIII 1000V/Max.10A

**Material**  
 Insulator:PA  
 Body:Brass & Stainless steel  
 Surface:Nickel plated  
**Rated voltage/current:**  
 CATIII 1000V/Max.10A

20.169. \*

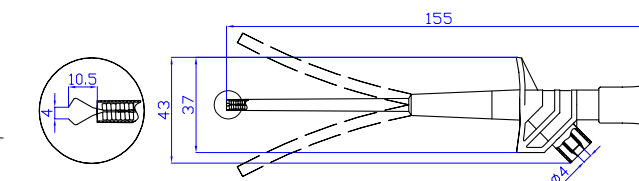

**Feature**

Safety test clip with 4mm socket connection. Flexible spring with the tube can contact the wires and terminals even at the corner.



**材质**  
 塑壳:PA  
 主体:铜和不锈钢  
 电气性能 :CATIII 1000V/Max.10A

**Material**  
 Insulator:PA  
 Body:Brass & Stainless steel  
**Rated voltage/current:**  
 CATIII 1000V/Max.10A



20.170. \*

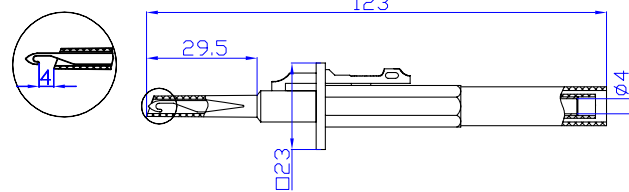

**Feature**  
Safety test clip with 4mm socket connection.  
The clip can connect the terminals easily.

**材质**  
塑壳 :PA  
主体 :铜和不锈钢  
电气性能 :CATIII 1000V/Max.20A

**Material**  
Insulator:PA  
Body:Brass & Stainless steel  
**Rated voltage/current:**  
CATIII 1000V/Max.10A

20.171. \*

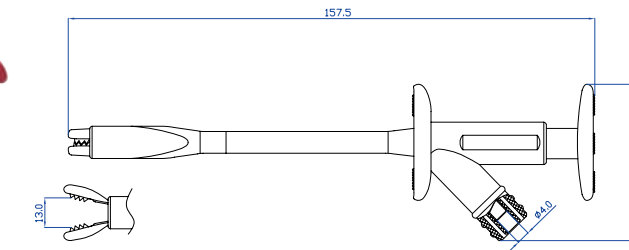
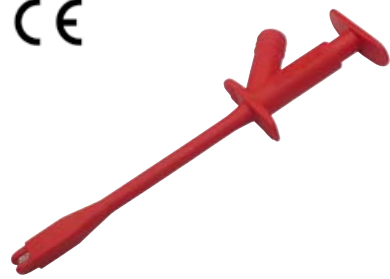

**Feature**  
Safety test clip with 4mm socket connection. Flexible spring with the tube can contact the wires and terminals even at the corner.

**材质**  
塑壳 :PA  
主体 :铜和不锈钢  
电气性能 :CATIII 1000V/Max.10A

**Material**  
Insulator:PA  
Body:Brass & Stainless steel  
**Rated voltage/current:**  
CATIII 1000V/Max.10A

20.211. \*



090.0058

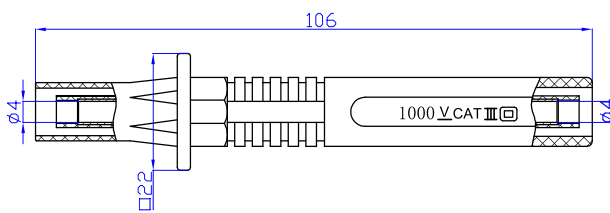

**Feature**  
Safety test probe with 4mm socket connection on both end. Fuse inside.

**材质**  
塑壳 :PA  
主体 :铜  
表面 :镀镍  
电气性能 :CATIII 1000V/Max.20A

**Material**  
Insulator:PA  
Body:Brass  
**Rated voltage/current:**  
CATIII 1000V/Max.20A

20.212. \*



090.0058

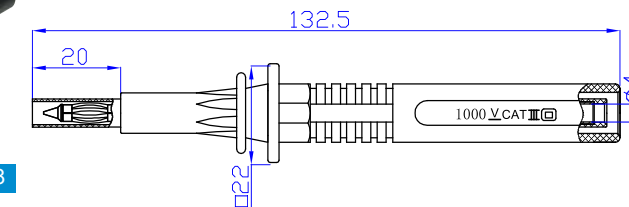

**Feature**  
Safety test probe with 4mm socket connection. Spring loaded side with the shrinkable tube. Fuse inside.

**材质**  
塑壳 :PA  
主体 :铜  
电气性能 :CATIII 1000V/Max.20A

**Material**  
Insulator:PA  
Body:Brass  
**Rated voltage/current:**  
CATIII 1000V/Max.20A

20.601. \*

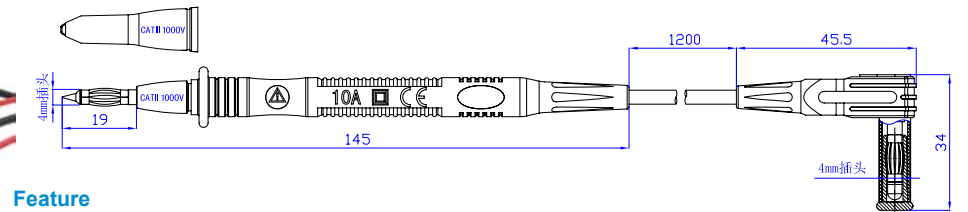

**Feature**  
Safety test lead one end with the insulated 4mm spring loaded test probe and the other end with the insulated 4mm angled plug. Nickel plated plugs with the protective cap. Red+Black as a set.

**Rated voltage/current:** CATIII 1000V/10A 0.75mm<sup>2</sup> PVC 100

20.602. \*

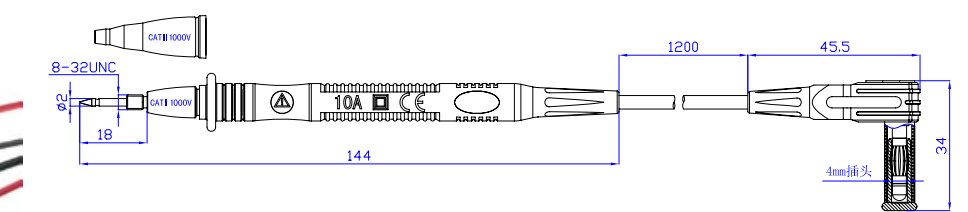

**Feature**  
Safety test lead one end with the insulated test probe and the other end with the insulated 4mm angled plug. Nickel plated plugs with the protective cap. Red+Black as a set.

**Rated voltage/current:** CATIII 1000V/10A 0.75mm<sup>2</sup> PVC 100

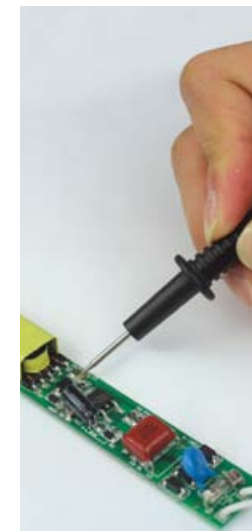











25.425. \*



**材质 Material**  
 塑壳 Insulator: PE  
 主体 Body: 镀铜 Beryllium copper  
 弹片 Spring: 镀铜 Beryllium copper  
 表面 Surface: 镀金 Gold plated  
 \* 焊接 Solder connection  
**电气性能 Rated voltage/current**  
 30Vac-60Vdc/Max.19A

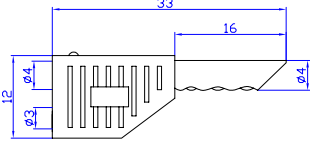

25.431. \*



**材质 Material**  
 塑壳 Insulator: PA  
 主体 Body: 铜 Brass  
 表面 Surface: 镀镍 Nickel plated  
 \* 焊接 Solder connection  
**电气性能 Rated voltage/current**  
 30Vac-60Vdc/Max.24A

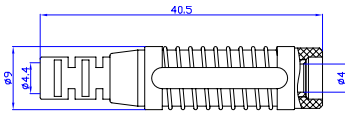

25.426. \*



**材质 Material**  
 塑壳 Insulator: PE  
 主体 Body: 铜 Brass  
 弹片 Spring: 钢 Steel  
 表面 Surface: 镀镍 Nickel plated  
 \* 焊接 Solder connection  
**电气性能 Rated voltage/current**  
 30Vac-60Vdc/Max.19A

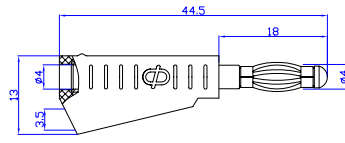

25.432. \*



**材质 Material**  
 塑壳 Insulator: PVC  
 主体 Body: 铜 Brass  
 表面 Surface: 镀镍 Nickel plated  
**电气性能 Rated voltage/current**  
 30Vac-60Vdc/Max.24A

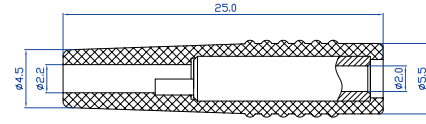

25.427. \*



**材质 Material**  
 塑壳 Insulator: PE  
 主体 Body: 铜 Brass  
 弹片 Spring: 镀铜 Beryllium copper  
 表面 Surface: 镀镍 Nickel plated  
**电气性能 Rated voltage/current**  
 30Vac-60Vdc/Max.32A

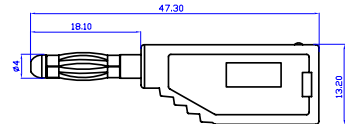

25.433. \*



**材质 Material**  
 塑壳 Insulator: ABS  
 主体 Body: 铜 Brass  
 表面 Surface: 镀镍 Nickel plated  
**电气性能 Rated voltage/current**  
 30Vac-60Vdc/Max.32A

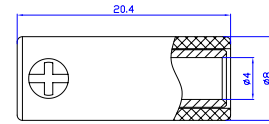

25.430. \*



**材质 Material**  
 塑壳 Insulator: PVC  
 主体 Body: 铜 Brass  
 表面 Surface: 镀镍 Nickel plated  
 \* 螺丝压接 Screw connection  
**电气性能 Rated voltage/current**  
 30Vac-60Vdc/Max.24A

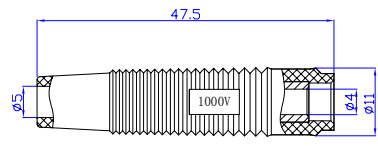

25.450. \*



**材质 Material**  
 塑壳 Insulator: PA  
 主体 Body: 铜 Brass  
 弹片 Spring: 镀铜 Beryllium copper  
 表面 Surface: 镀镍 Nickel plated  
 \* 焊接 Solder connection  
**电气性能 Rated voltage/current**  
 CATII 600V/Max.32A

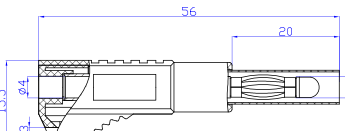

25.451. \*



**材质 Material**  
 塑壳 Insulator: PA  
 主体 Body: 铜 Brass  
 弹片 Spring: 镀铜 Beryllium copper  
 表面 Surface: 镀镍 Nickel plated  
 \* 按压 Press connection  
**电气性能 Rated voltage/current**  
 CATII 600V/Max.32A

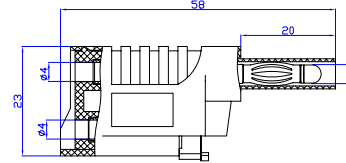

25.502. \*



**材质 Material**  
 塑壳 Insulator: PA  
 主体 Body: 铜 Brass  
 弹片 Spring: 镀铜 Beryllium copper  
 表面 Surface: 镀镍 Nickel plated  
 \* 焊接 Solder connection  
**电气性能 Rated voltage/current**  
 CATII 600V/Max.32A

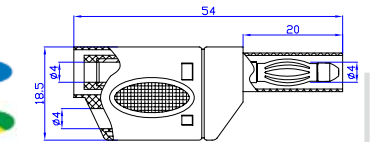

25.452. \*



**材质 Material**  
 塑壳 Insulator: PA  
 主体 Body: 铜 Brass  
 弹片 Spring: 镀铜 Beryllium copper  
 表面 Surface: 镀镍 Nickel plated  
**电气性能 Rated voltage/current**  
 30Vac-60Vdc/Max.32A

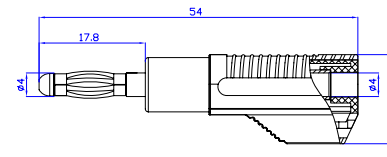

25.503. \*



**材质 Material**  
 塑壳 Insulator: PA  
 主体 Body: 铜 Brass  
 弹片 Spring: 镀铜 Beryllium copper  
 表面 Surface: 镀镍 Nickel plated  
 \* 焊接 Solder connection  
**电气性能 Rated voltage/current**  
 CATII 1000V/Max.32A

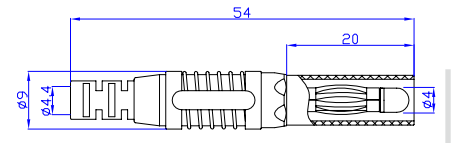

25.454. \*



**材质 Material**  
 塑壳 Insulator: PA  
 主体 Body: 铜 Brass  
 弹片 Spring: 镀铜 Beryllium copper  
 表面 Surface: 镀镍 Nickel plated  
**电气性能 Rated voltage/current**  
 30Vac-60Vdc/Max.32A

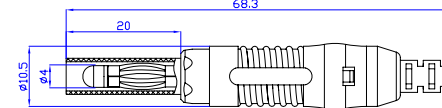

25.504. \*



**材质 Material**  
 塑壳 Insulator: PA  
 主体 Body: 铜 Brass  
 弹片 Spring: 镀铜 Beryllium copper  
 表面 Surface: 镀镍 Nickel plated  
 \* 焊接 Solder connection  
**电气性能 Rated voltage/current**  
 CATII 1000V/Max.32A

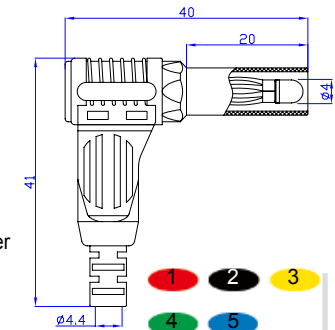

25.501. \*



**材质 Material**  
 塑壳 Insulator: PA  
 主体 Body: 铜 Brass  
 弹片 Spring: 镀铜 Beryllium copper  
 表面 Surface: 镀镍 Nickel plated  
 \* 焊接 Solder connection  
**电气性能 Rated voltage/current**  
 CATII 600V/Max.32A

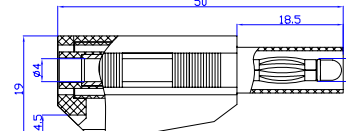

25.505. \*



**材质 Material**  
 塑壳 Insulator: PA  
 主体 Body: 铜 Brass  
 表面 Surface: 镀镍 Nickel plated  
 \* 焊接 Solder connection  
**电气性能 Rated voltage/current**  
 CATII 600V/Max.19A

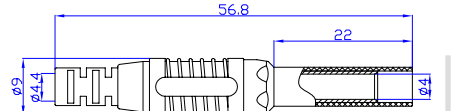



26.121.\*



**材质 Material**

塑壳 Insulator: ABS  
主体 Body: 铜 Brass  
弹片 Spring: 铍铜 Beryllium copper  
表面 Surface: 镀金 Gold plated  
电气性能 Rated voltage/current  
30Vac-60Vdc/Max.10A

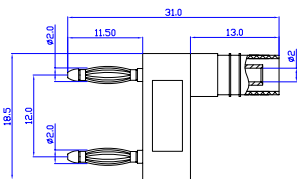

26.122.\*



**材质 Material**

塑壳 Insulator: ABS  
主体 Body: 铜 Brass  
弹片 Spring: 铍铜 Beryllium copper  
表面 Surface: 镀金 Gold plated  
电气性能 Rated voltage/current  
30Vac-60Vdc/Max.10A

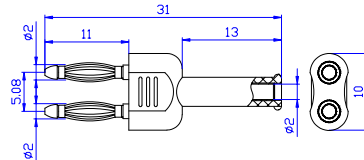

26.123.\*



**材质 Material**

塑壳 Insulator: PA  
主体 Body: 铜 Brass  
弹片 Spring: 铍铜 Beryllium copper  
表面 Surface: 镀金 Gold plated  
电气性能 Rated voltage/current  
30Vac-60Vdc/Max.10A

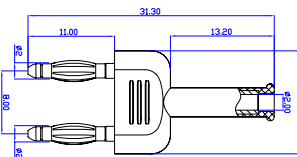

26.124.\*



**材质 Material**

塑壳 Insulator: PA  
主体 Body: 铜 Brass  
弹片 Spring: 铍铜 Beryllium copper  
表面 Surface: 镀金 Gold plated  
电气性能 Rated voltage/current  
30Vac-60Vdc/Max.10A

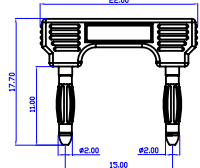

26.201.\*



**材质 Material**

塑壳 Insulator: ABS  
主体 Body: 铜 Brass  
弹片 Spring: 铍铜 Beryllium copper  
表面 Surface: 镀镍 Nickel plated  
电气性能 Rated voltage/current  
30Vac-60Vdc/Max.32A

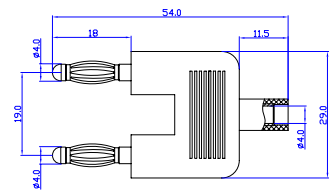

26.202.\*



**材质 Material**

塑壳 Insulator: ABS  
主体 Body: 铜 Brass  
弹片 Spring: 铍铜 Beryllium copper  
表面 Surface: 镀镍 Nickel plated  
电气性能 Rated voltage/current  
30Vac-60Vdc/Max.32A

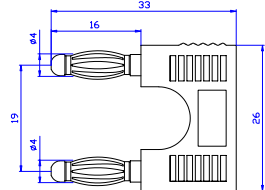

26.203.\*



**材质 Material**

塑壳 Insulator: ABS  
主体 Body: 铜 Brass  
弹片 Spring: 铍铜 Beryllium copper  
表面 Surface: 镀镍 Nickel plated  
电气性能 Rated voltage/current  
30Vac-60Vdc/Max.32A

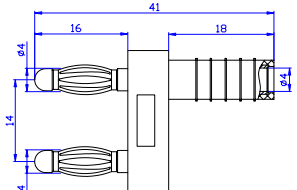

26.205.\*



**材质 Material**

塑壳 Insulator: ABS  
主体 Body: 铜 Brass  
弹片 Spring: 铍铜 Beryllium copper  
表面 Surface: 镀镍 Nickel plated  
电气性能 Rated voltage/current  
30Vac-60Vdc/Max.32A

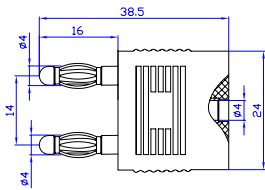

26.220



**材质 Material**

主体 Body: 铜 Brass  
弹片 Spring: 铍铜 Beryllium copper  
表面 Surface: 镀镍 Nickel plated  
电气性能 Rated voltage/current  
30Vac-60Vdc/Max.32A

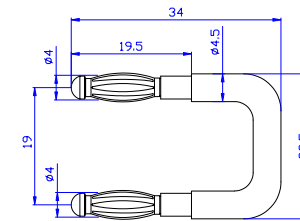

26.221.\*



**材质 Material**

塑壳 Insulator: ABS  
主体 Body: 铜 Brass  
弹片 Spring: 铍铜 Beryllium copper  
表面 Surface: 镀镍 Nickel plated  
电气性能 Rated voltage/current  
CAT II 1000V/Max.32A

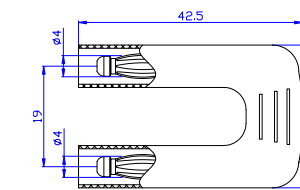

26.222.\*



**材质 Material**

塑壳 Insulator: PA  
主体 Body: 铜 Brass  
弹片 Spring: 铍铜 Beryllium copper  
表面 Surface: 镀镍 Nickel plated  
电气性能 Rated voltage/current  
CAT II 1000V/Max.32A

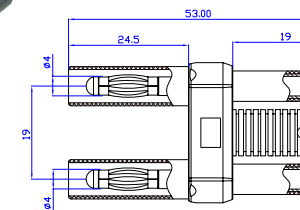

26.223.\*



**材质 Material**

主体 Body: 铜 Brass  
弹片 Spring: 铍铜 Beryllium copper  
表面 Surface: 镀镍 Nickel plated  
电气性能 Rated voltage/current  
30Vac-60Vdc/Max.32A

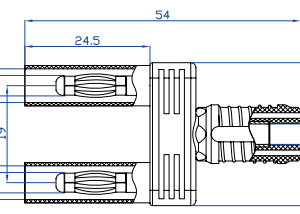

26.410.\*



**材质 Material**

塑壳 Insulator: PVC  
主体 Body: 铜 Brass  
表面 Surface: 镀镍 Nickel plated  
电气性能 Rated voltage/current  
30Vac-60Vdc/Max.19A

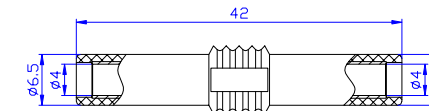

26.420.\*



**材质 Material**

塑壳 Insulator: PVC  
主体 Body: 铜 Brass  
表面 Surface: 镀镍 Nickel plated  
电气性能 Rated voltage/current  
30Vac-60Vdc/Max.24A

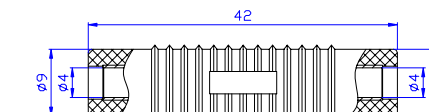

26.460.\*



**材质 Material**

主体 Body: 铜 Brass  
弹片 Spring: 铍铜 Beryllium copper  
表面 Surface: 镀镍 Nickel plated  
电气性能 Rated voltage/current  
30Vac-60Vdc/Max.32A

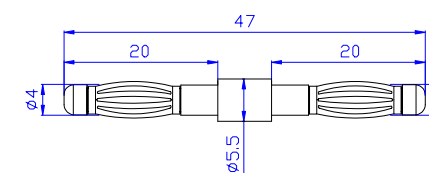

26.480

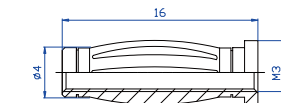

26.481

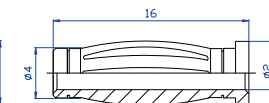



26.450.\*



**材质 Material**  
 塑壳 Insulator: PA  
 主体 Body: 铜 Brass  
 表面 Surface: 镀镍 Nickel plated  
**电气性能 Rated voltage/current**  
 30Vac-60Vdc/Max.36A

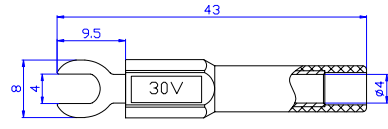

26.456.\*



**材质 Material**  
 塑壳 Insulator: PA  
 主体 Body: 铜 Brass  
 弹片 Spring: 铍铜 Beryllium copper  
 表面 Surface: 镀镍 Nickel plated  
**电气性能 Rated voltage/current**  
 30Vac-60Vdc/Max.10A

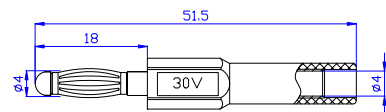

26.451.\*



**材质 Material**  
 塑壳 Insulator: PA  
 主体 Body: 铜 Brass  
 表面 Surface: 镀镍 Nickel plated  
**电气性能 Rated voltage/current**  
 30Vac-60Vdc/Max.36A

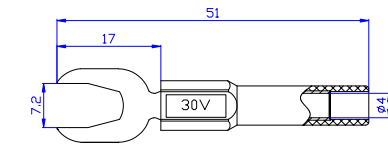

26.470.\*



**材质 Material**  
 塑壳 Insulator: PA  
 主体 Body: 铜 Brass  
 表面 Surface: 镀镍 Nickel plated  
**电气性能 Rated voltage/current**  
 30Vac-60Vdc/Max.10A

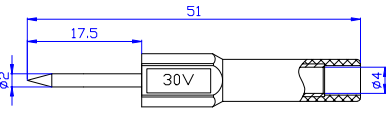

26.452.\*



**材质 Material**  
 塑壳 Insulator: PA  
 主体 Body: 铜 Brass  
 弹片 Spring: 铍铜 Beryllium copper  
 表面 Surface: 镀金 Gold plated  
**电气性能 Rated voltage/current**  
 30Vac-60Vdc/Max.36A

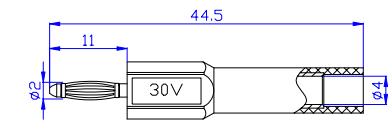

26.455.\*



**材质 Material**  
 塑壳 Insulator: PA  
 主体 Body: 铜 Brass  
 弹片 Spring: 铍铜 Beryllium copper  
 表面 Surface: 镀镍 Nickel plated  
**电气性能 Rated voltage/current**  
 30Vac-60Vdc/Max.10A

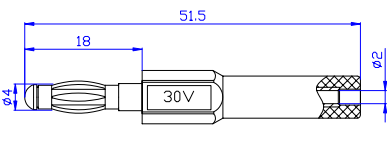

28.110



**材质 Material**  
 主体 Body: 铜 Brass  
 表面 Surface: 镀金 Gold plated

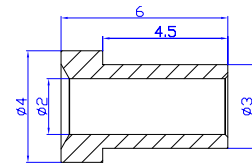

28.111



**材质 Material**  
 主体 Body: 铜 Brass  
 表面 Surface: 镀金 Gold plated  
**电气性能 Rated voltage/current**

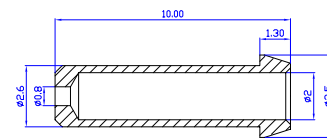

28.112



**材质 Material**  
 主体 Body: 铜 Brass  
 表面 Surface: 镀金 Gold plated  
**电气性能 Rated voltage/current**

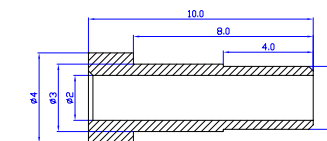

28.220



**材质 Material**  
 主体 Body: 铜 Brass  
 表面 Surface: 镀镍 Nickel plated

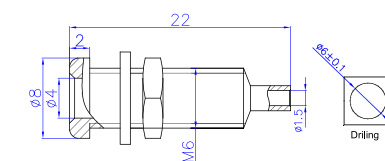

28.230



**材质 Material**  
 主体 Body: 铜 Brass  
 表面 Surface: 镀镍 Nickel plated

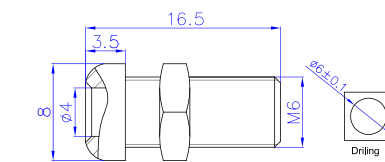

28.33\*



Item No.	T	L
28.330	M2.0	6.5
28.331	M2.5	6.5

**材质 Material**  
 主体 Body: 铜 Brass  
 弹片 Spring: 铍铜 Beryllium copper  
 表面 Surface: 镀金 Gold plated

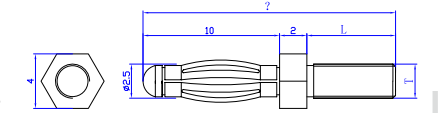

28.36\*



Item No.	T	L
28.360	M2.0	6.5
28.361	M2.0	10.0

**材质 Material**  
 主体 Body: 铜 Brass  
 弹片 Spring: 铍铜 Beryllium copper  
 表面 Surface: 镀金 Gold plated

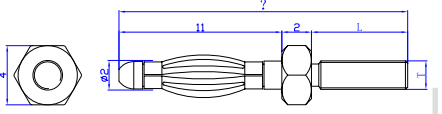

28.370



**材质 Material**  
 主体 Body: 铜 Brass  
 弹片 Spring: 铍铜 Beryllium copper  
 表面 Surface: 镀镍 Nickel plated

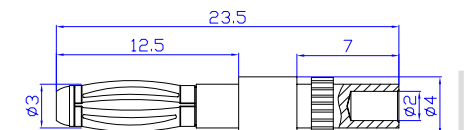

28.41\*



**材质 Material**  
 主体 Body: 铜 Brass  
 弹片 Spring: 铍铜 Beryllium copper  
 表面 Surface: 镀镍 Nickel plated

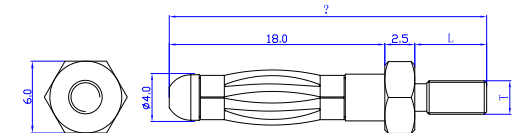

Item No.	T	L
28.410	M3.0	6.0
28.411	M3.0	10.0
28.412	M4.0	4.5
28.413	M4.0	6.0
28.414	M4.0	9.0
28.415	M4.0	18.0



28.420

**材质 Material**  
主体 Body: 铜 Brass  
弹片 Spring: 铍铜 Beryllium copper  
表面 Surface: 镀金 Gold plated

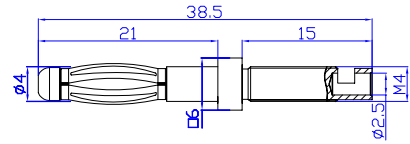

28.461

**材质 Material**  
主体 Body: 铜 Brass  
弹片 Spring: 铍铜 Beryllium copper  
表面 Surface: 镀镍 Nickel plated

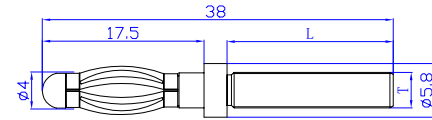

28.430

**材质 Material**  
主体 Body: 铜 Brass  
弹片 Spring: 铍铜 Beryllium copper  
表面 Surface: 镀金 Gold plated

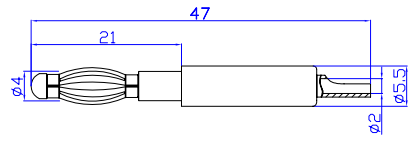

28.510

**材质 Material**  
主体 Body: 铜 Brass  
弹片 Spring: 铍铜 Beryllium copper  
表面 Surface: 镀镍 Nickel plated

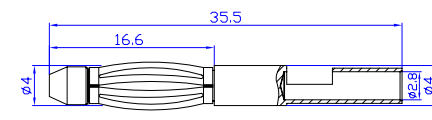

28.440

**材质 Material**  
主体 Body: 铜 Brass  
弹片 Spring: 铍铜 Beryllium copper  
表面 Surface: 镀镍 Nickel plated

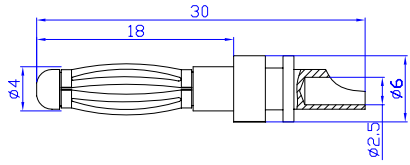

28.520

**材质 Material**  
主体 Body: 铜 Brass  
弹片 Spring: 铍铜 Beryllium copper  
表面 Surface: 镀镍 Nickel plated

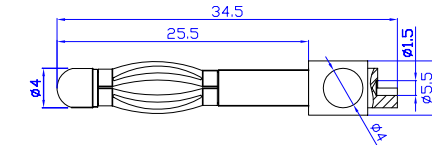

28.441

**材质 Material**  
主体 Body: 铜 Brass  
弹片 Spring: 锰钢 Steel  
表面 Surface: 镀镍 Nickel plated

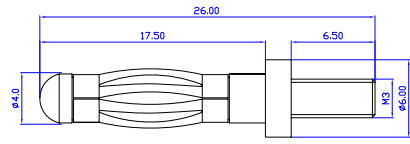

28.610

**材质 Material**  
主体 Body: 铜 Brass  
弹片 Spring: 铍铜 Beryllium copper  
表面 Surface: 镀金 Gold plated

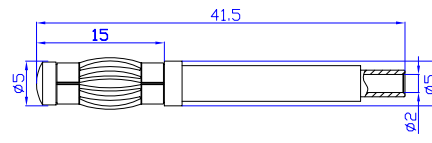

28.450

**材质 Material**  
主体 Body: 铜 Brass  
弹片 Spring: 铍铜 Beryllium copper  
表面 Surface: 镀镍 Nickel plated

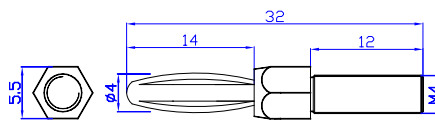

28.620

**材质 Material**  
主体 Body: 铜 Brass  
弹片 Spring: 铍铜 Beryllium copper  
表面 Surface: 镀银 Silver plated

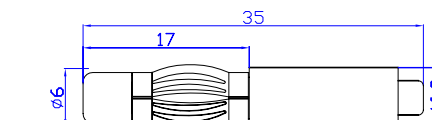

28.710

**材质 Material**  
主体 Body: 铜 Brass  
弹片 Spring: 铍铜 Beryllium copper  
表面 Surface: 镀镍 Nickel plated

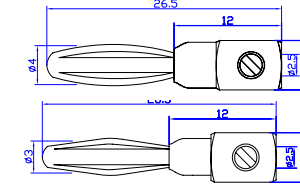

28.910

**材质 Material**  
主体 Body: 铜 Brass  
表面 Surface: 镀镍 Nickel plated

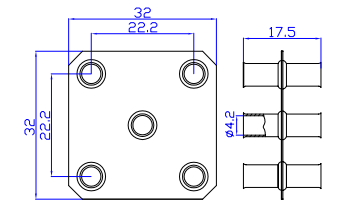

28.711

**材质 Material**  
主体 Body: 铜 Brass  
弹片 Spring: 锰钢 Steel  
表面 Surface: 镀镍 Nickel plated

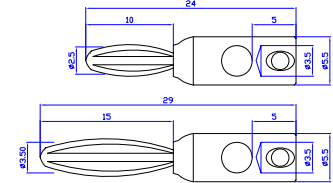

28.712

**材质 Material**  
主体 Body: 铜 Brass  
弹片 Spring: 锰钢 Steel  
表面 Surface: 镀金 Gold plated

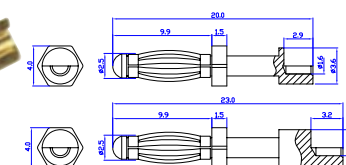

28.803

**材质 Material**  
主体 Body: 铜 Brass  
弹片 Spring: 铍铜 Beryllium copper  
表面 Surface: 镀金 Gold plated

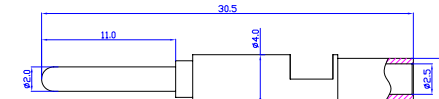

28.804

**材质 Material**  
主体 Body: 铜 Brass  
表面 Surface: 镀金 Gold plated

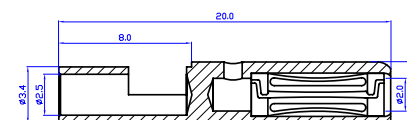



24.101.\*



**材质 Material**  
 塑壳 Insulator: PA  
 主体 Body: 铜 Brass  
 表面 Surface: 镀金 Gold plated  
 电气性能 Rated voltage/current  
 30Vac-60Vdc/Max.10A

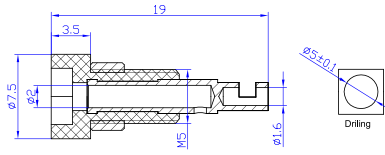

24.106.\*



**材质 Material**  
 塑壳 Insulator: ABS  
 主体 Body: 铜 Brass  
 表面 Surface: 镀镍 Nickel plated  
 电气性能 Rated voltage/current  
 30Vac-60Vdc/Max.10A

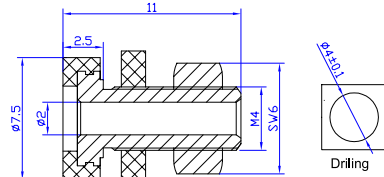

24.102.\*



**材质 Material**  
 塑壳 Insulator: ABS  
 主体 Body: 铜 Brass  
 表面 Surface: 镀镍 Nickel plated  
 电气性能 Rated voltage/current  
 30Vac-60Vdc/Max.6A

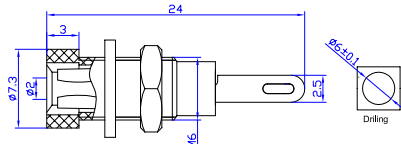

24.107.\*



**材质 Material**  
 塑壳 Insulator: ABS  
 主体 Body: 铜 Brass  
 表面 Surface: 镀镍 Nickel plated  
 电气性能 Rated voltage/current  
 30Vac-60Vdc/Max.10A

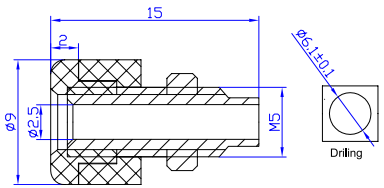

24.103.\*



**材质 Material**  
 塑壳 Insulator: PA  
 主体 Body: 铜 Brass  
 表面 Surface: 镀镍 Nickel plated  
 电气性能 Rated voltage/current  
 30Vac-60Vdc/Max.10A

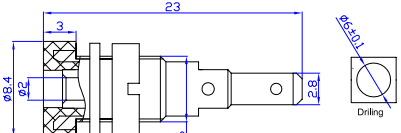

24.110.\*



**材质 Material**  
 塑壳 Insulator: PA  
 主体 Body: 铜 Brass  
 表面 Surface: 镀金 Gold plated  
 电气性能 Rated voltage/current  
 30Vac-60Vdc/Max.10A

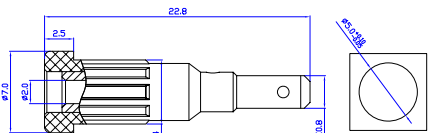

24.104.\*



**材质 Material**  
 塑壳 Insulator: PA  
 主体 Body: 铜 Brass  
 表面 Surface: 镀镍 Nickel plated  
 电气性能 Rated voltage/current  
 30Vac-60Vdc/Max.10A

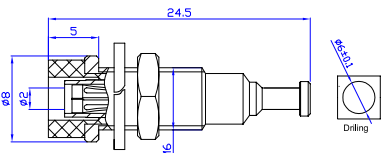

24.111.\*



**材质 Material**  
 塑壳 Insulator: PA  
 主体 Body: 铜 Brass  
 表面 Surface: 镀金 Gold plated  
 电气性能 Rated voltage/current  
 30Vac-60Vdc/Max.10A

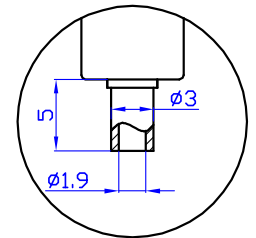
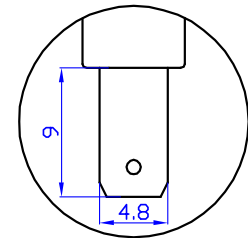
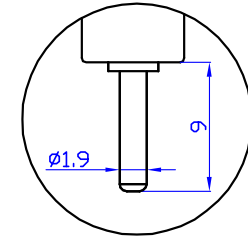
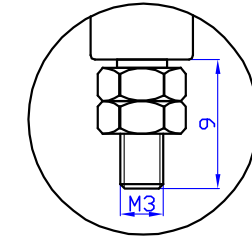
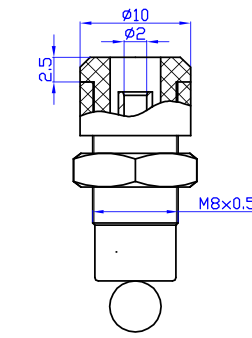
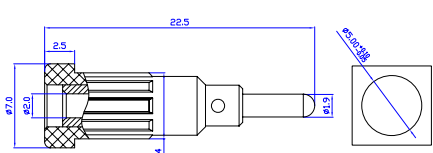

24.131.\*

24.132.\*

24.133.\*

24.134.\*

型号 Model.	材质 Material	电气性能 Rated voltage/current
24.131.*	塑壳 Insulator: PA	CATIII 600V/Max.10A
24.132.*	主体 Body: 铜 Brass	
24.133.*	表面 Surface: 镀镍或镀金	
24.134.*	Nickel or Gold plated	



24.241.\*



**材质 Material**  
 塑壳 Insulator: PA  
 主体 Body: 铜 Brass  
 表面 Surface: 镀镍 Nickel plated  
 电气性能 Rated voltage/current  
 30Vac-60Vdc/Max.24A

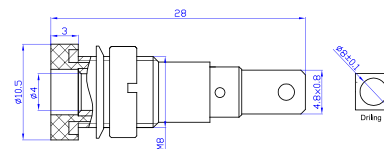

24.243.\*



**材质 Material**  
 塑壳 Insulator: PA  
 主体 Body: 铜 Brass  
 表面 Surface: 镀银 Silver plated  
 电气性能 Rated voltage/current  
 30Vac-60Vdc/Max.24A

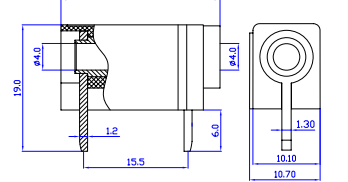
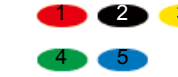

24.242.\*



**材质 Material**  
 塑壳 Insulator: PA  
 主体 Body: 铜 Brass  
 表面 Surface: 镀镍 Nickel plated  
 电气性能 Rated voltage/current  
 30Vac-60Vdc/Max.24A

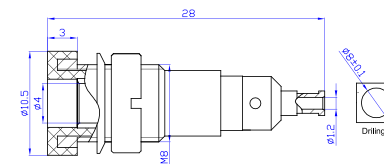

24.244.\*



**材质 Material**  
 塑壳 Insulator: ABS  
 主体 Body: 铜 Brass  
 表面 Surface: 镀锌 Zinc plated  
 电气性能 Rated voltage/current  
 30Vac-60Vdc/Max.24A

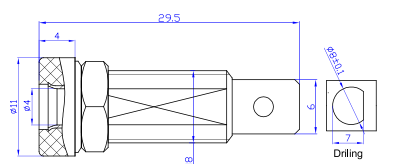



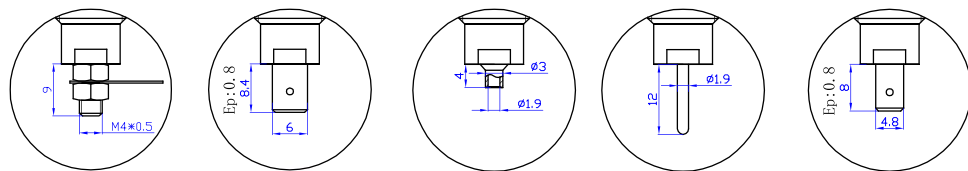
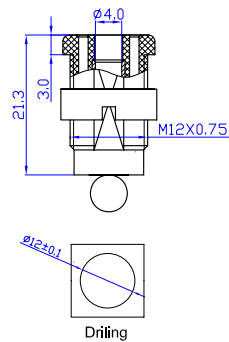

24.331.\* 24.332.\* 24.333.\* 24.334.\* 24.335.\*

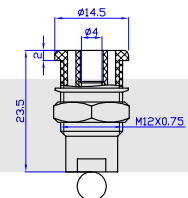

24.341.\* 24.342.\* 24.343.\* 24.344.\* 24.345.\*

型号 Model.	材质 Material	电气性能 Rated voltage/current
24.331.* 24.341.*	塑壳 Insulator:ABS 主体 Body: 铜 Brass 表面 Surface: 镀镍 Nickel plated	CATII 600V/Max.32A
24.332.* 24.342.*		
24.333.* 24.343.*		CATII 600V/Max.24A
24.334.* 24.344.*		CATII 600V/Max.32A
24.335.* 24.345.*		

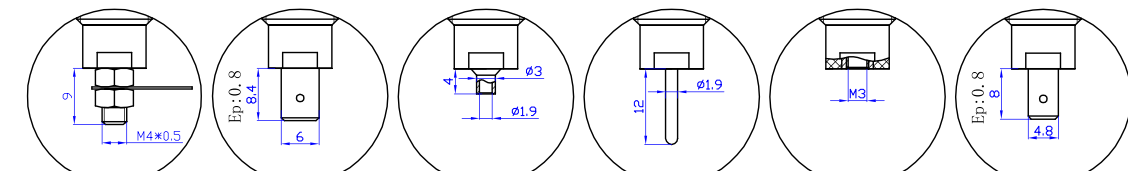
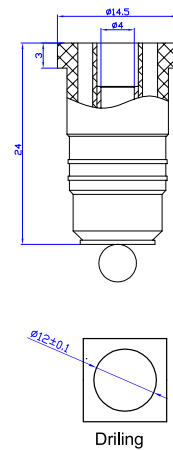
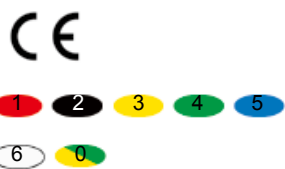

24.321.\* 24.322.\* 24.323.\* 24.324.\* 24.325.\* 24.326.\*

型号 Model.	材质 Material	电气性能 Rated voltage/current
24.321.*	塑壳 Insulator:PA 主体 Body: 铜 Brass 表面 Surface: 镀镍 Nickel plated	CATIII 1000V/Max.32A
24.322.*		
24.323.*		CATIII 1000V/Max.24A
24.324.*		CATIII 1000V/Max.32A
24.325.*		
24.326.*		

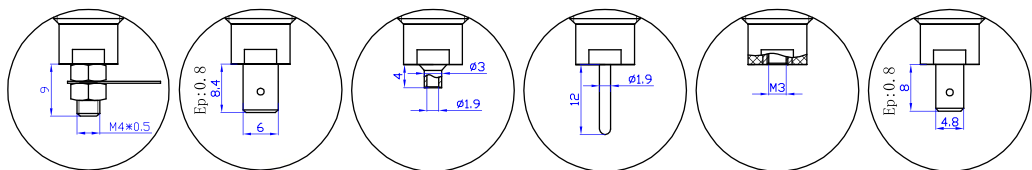
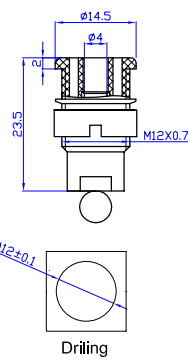

24.301.\* 24.302.\* 24.303.\* 24.304.\* 24.305.\* 24.306.\*

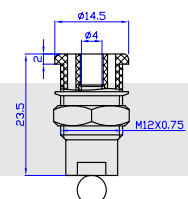

24.311.\* 24.312.\* 24.313.\* 24.314.\* 24.315.\* 24.316.\*

型号 Model.	材质 Material	电气性能 Rated voltage/current
24.301.* 24.311.*	塑壳 Insulator:PA 主体 Body: 铜 Brass 表面 Surface: 镀镍 Nickel plated	CATIII 1000V/Max.32A
24.302.* 24.312.*		
24.303.* 24.313.*		CATIII 1000V/Max.24A
24.304.* 24.314.*		CATIII 1000V/Max.32A
24.305.* 24.315.*		
24.306.* 24.316.*		

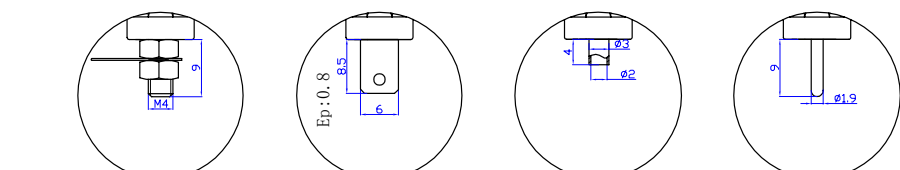
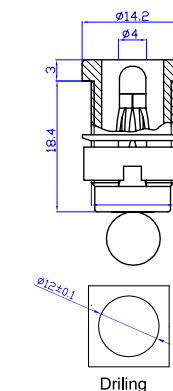

24.381.\* 24.382.\* 24.383.\* 24.384.\*

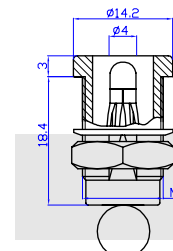

24.391.\* 24.392.\* 24.393.\* 24.394.\*

型号 Model.	材质 Material	电气性能 Rated voltage/current
24.381.* 24.391.*	塑壳 Insulator:PA 主体 Body: 铜 Brass 表面 Surface: 镀镍 Nickel plated	CATIII 1000V/Max.32A
24.382.* 24.392.*		
24.383.* 24.393.*		CATIII 1000V/Max.24A
24.384.* 24.394.*		CATIII 1000V/Max.32A









24.832.\*



**材质 Material**  
 塑壳 Insulator: ABS  
 主体 Body: 铜 Brass  
 表面 Surface: 镀镍 Nickel plated  
**电气性能 Rated voltage/current**  
 30Vac-60Vdc/Max.24A

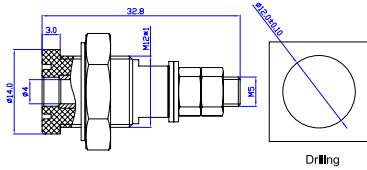

24.935.\*



**Material**  
 Insulator:ABS  
 Body:Brass  
 Surface:Nickel plated  
**Rated voltage/current**  
 30Vac-60Vdc/Max.80A

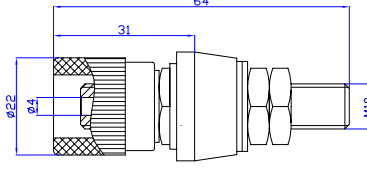

24.932.\*



**材质 Material**  
 塑壳 Insulator: ABS  
 主体 Body: 铜 Brass  
 表面 Surface: 镀镍 Nickel plated  
**电气性能 Rated voltage/current**  
 30Vac-60Vdc/Max.50A

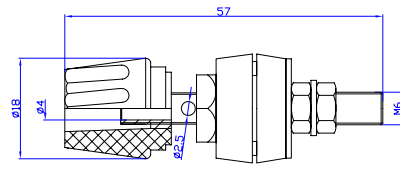

24.936.\*



**Material**  
 Insulator:ABS  
 Body:Brass  
 Surface:Nickel plated  
**Rated voltage/current**  
 30Vac-60Vdc/Max.100A

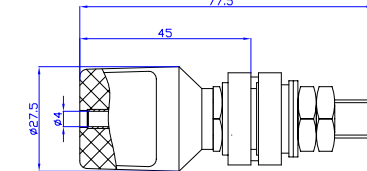

24.933.\*



**材质 Material**  
 塑壳 Insulator: ABS  
 主体 Body: 铜 Brass  
 表面 Surface: 镀镍 Nickel plated  
**电气性能 Rated voltage/current**  
 30Vac-60Vdc/Max.60A

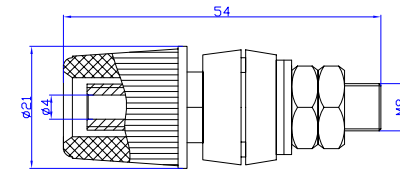

24.937.\*



**Material**  
 Insulator:ABS  
 Body:Brass  
 Surface:Nickel plated  
**Rated voltage/current**  
 30Vac-60Vdc/Max.150A

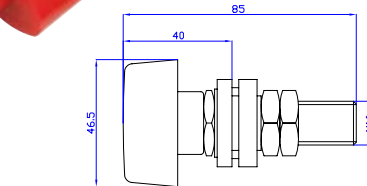

24.934.\*

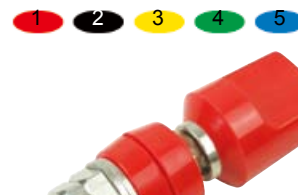

**Material**  
 Insulator:ABS  
 Body:Brass  
 Surface:Nickel plated  
**Rated voltage/current**  
 30Vac-60Vdc/Max.60A

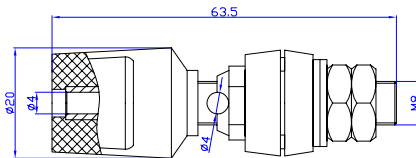
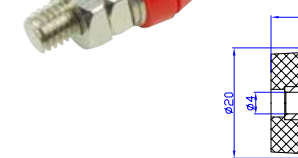

°C  
+70  
-10  
PVC

Item No. (型号)	Cross Section (线规) mm <sup>2</sup> /AWG	Outer diameter. 外径 mm	额定电压、电流 (Rated Volatge&Current)V/A	
011.0046	0.5/20	2.3	1500/10	1 2 3 4 5 6
011.0137	0.75/18	2.8	1500/15	1 2 3 4 5 6
011.0026	0.75/18	3.5	1500/15	1 2 3 4 5 6
011.0044	1.00/17	3.9	1500/19	1 2 3 4 5 6 7
011.0043	2.50/13	3.9	1500/32	1 2 3 4 5 6 7

°C  
+160  
-40  
SIL

Item No. (型号)	Cross Section (线规) mm <sup>2</sup> /AWG	Outer diameter. 外径 mm	额定电压、电流 (Rated Volatge&Current)V/A	
011.0078	0.5/20	1.8	1500/10	1 2 3 4 5 6
011.0066	0.75/18	3.5	1500/15	1 2 3 4 5 6
011.0063	1.00/17	3.9	1500/19	1 2 3 4 5 6 7
011.0136	2.50/13	3.9	1500/32	1 2 3 4 5 6 7



### 2mm Test Lead

Test lead with the 2mm gold plated plug on both ends.

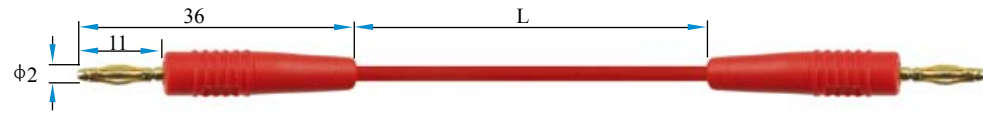

22.030.□*	Rated voltage/current: 30Vac-60Vdc/Max.10A	0.50mm <sup>2</sup> PVC	025	050	
22.040.□*	Rated voltage/current: 30Vac-60Vdc/Max.10A	0.50mm <sup>2</sup> SIL	025	050	100

### 2mm Test Lead

Test lead with the 2mm stackable gold plated plug on both ends.

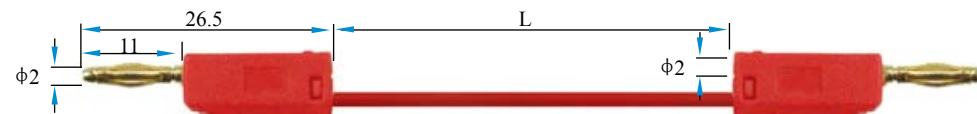

22.050.□*	Rated voltage/current: 30Vac-60Vdc/Max.10A	0.50mm <sup>2</sup> PVC	025	050	100
22.060.□*	Rated voltage/current: 30Vac-60Vdc/Max.10A	0.50mm <sup>2</sup> SIL	025	050	100

### 4mm Test Lead

Test lead with the 4mm stackable nickel plated plug on both ends.

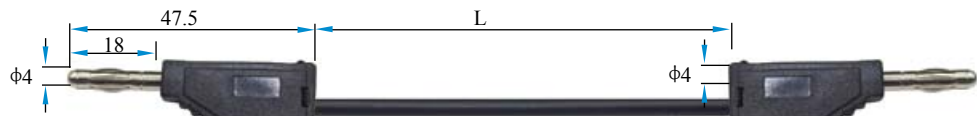

22.090.□*	Rated voltage/current: 30Vac-60Vdc/Max.15A	0.75mm <sup>2</sup> PVC	025	050	100
22.091.□*	Rated voltage/current: 30Vac-60Vdc/Max.15A	0.75mm <sup>2</sup> SIL	025	050	100

### 4mm Test Lead

Test lead with the 4mm stackable nickel plated plug on both ends.

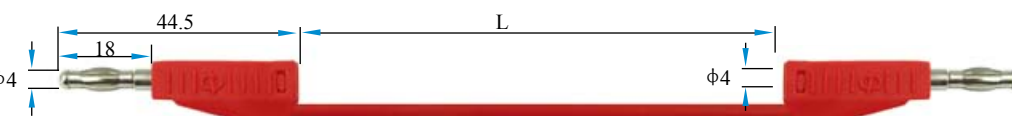

22.100.□*	Rated voltage/current: 30Vac-60Vdc/Max.15A	0.75mm <sup>2</sup> PVC	025	050	100
22.111.□*	Rated voltage/current: 30Vac-60Vdc/Max.15A	0.75mm <sup>2</sup> SIL	025	050	100
22.110.□*	Rated voltage/current: 30Vac-60Vdc/Max.19A	1.0mm <sup>2</sup> JBF	025	050	100

### 4mm Test Lead

Test lead with the 4mm stackable gold plated plug on both ends.

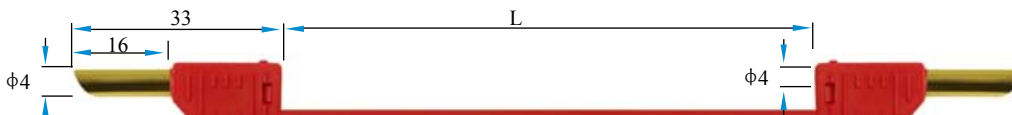

22.120.□*	Rated voltage/current: 30Vac-60Vdc/Max.15A	0.75mm <sup>2</sup> PVC	025	050	100
22.121.□*	Rated voltage/current: 30Vac-60Vdc/Max.19A	1.0mm <sup>2</sup> JBF	025	050	100

### 4mm Test Lead

Test lead with the injected 4mm stackable nickel plated plug on both ends.

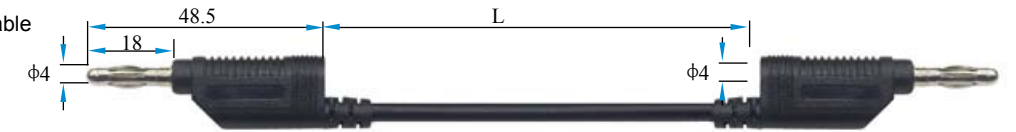

22.162.□*	Rated voltage/current: 30Vac-60Vdc/Max.32A	2.5mm <sup>2</sup> SIL	025	050	100
22.171.□*	Rated voltage/current: 30Vac-60Vdc/Max.15A	0.75mm <sup>2</sup> PVC	025	050	100
22.172.□*	Rated voltage/current: 30Vac-60Vdc/Max.19A	0.75mm <sup>2</sup> PVC	025	050	100
22.170.□*	Rated voltage/current: 30Vac-60Vdc/Max.32A	2.5mm <sup>2</sup> PVC	025	050	100

### 4mm Test Lead

Test lead with the 4mm nickel plated plug on both ends.

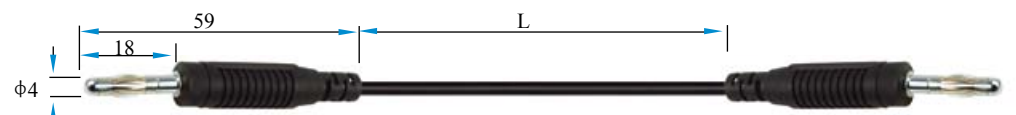

22.190.□*	Rated voltage/current: 30Vac-60Vdc/Max.15A	0.75mm <sup>2</sup> PVC	025	050	100
22.201.□*	Rated voltage/current: 30Vac-60Vdc/Max.15A	0.75mm <sup>2</sup> SIL	025	050	100

### 4mm Safety Test Lead

Safety test lead one end with the insulated 4mm straight plug and the other end with the insulated 4mm angled plug. Nickel plated plugs with the protective cap. Injected type.

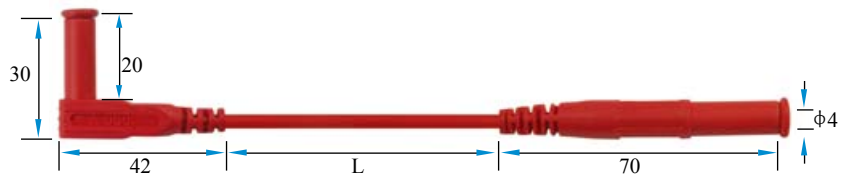

22.210.□*	Rated voltage/current: CATIII 1000V/15A	0.75mm <sup>2</sup> PVC	025	050	100	CE
-----------	---	-------------------------	-----	-----	-----	----



### 4mm Safety Test Lead

Safety test lead with the insulated 4mm angled plug on both ends. Nickel plated plugs with the protective cap. Injected type.



22.241.□*	Rated voltage/current: CATIII 1000V/15A	0.75mm <sup>2</sup> PVC	025	050	100	CE
-----------	---	-------------------------	-----	-----	-----	----



### 4mm Safety Test Lead

Safety test lead with the insulated 4mm stackable plug on both ends. Nickel plated plugs with the red cap.

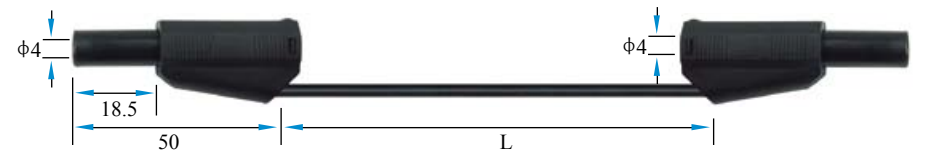

22.390.□*	Rated voltage/current: CATIII 600V/19A	1.0mm <sup>2</sup> JBF	025	050	100	CE
22.391.□*	Rated voltage/current: CATIII 600V/32A	2.5mm <sup>2</sup> JBF	025	050	100	CE
22.401.□*	Rated voltage/current: CATIII 600V/32A	2.5mm <sup>2</sup> SIL	025	050	100	CE





### 4mm Safety Test Lead

Safety test lead one end with the insulated 4mm straight plug and the other end with the insulated 4mm angled plug. Nickel plated plugs with the protective cap. Assembled type.

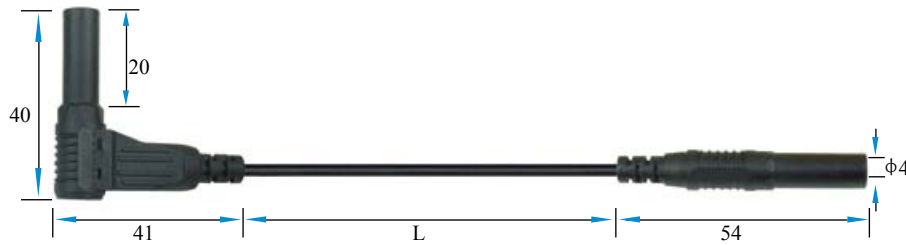

1 2 3 4 5

22.270.□*	Rated voltage/current: CATIII 1000V/15A	0.75mm <sup>2</sup> PVC	025	050	100	CE
22.280.□*	Rated voltage/current: CATIII 1000V/19A	1.0mm <sup>2</sup> PVC	025	050	100	CE
22.281.□*	Rated voltage/current: CATIII 1000V/32A	2.5mm <sup>2</sup> PVC	025	050	100	CE
22.291.□*	Rated voltage/current: CATIII 1000V/19A	1.0mm <sup>2</sup> SIL	025	050	100	CE
22.290.□*	Rated voltage/current: CATIII 1000V/32A	2.5mm <sup>2</sup> SIL	025	050	100	CE



### 4mm Safety Test Lead

Safety test lead with the insulated 4mm straight plug on both ends. Nickel plated plugs with the protective cap. Assembled type.

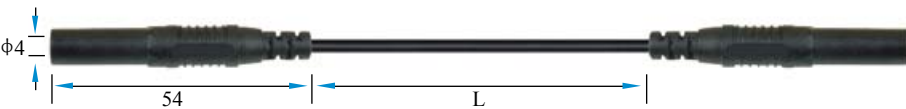

1 2 3 4 5

22.300.□*	Rated voltage/current: CATIII 1000V/15A	0.75mm <sup>2</sup> PVC	025	050	100	CE
22.310.□*	Rated voltage/current: CATIII 1000V/19A	1.0mm <sup>2</sup> PVC	025	050	100	CE
22.311.□*	Rated voltage/current: CATIII 1000V/32A	2.5mm <sup>2</sup> PVC	025	050	100	CE
22.321.□*	Rated voltage/current: CATIII 1000V/19A	1.0mm <sup>2</sup> SIL	025	050	100	CE
22.320.□*	Rated voltage/current: CATIII 1000V/32A	2.5mm <sup>2</sup> SIL	025	050	100	CE



### 4mm Safety Test Lead

Safety test lead with the insulated 4mm stackable plug on both ends. Nickel plated plugs with the red cap.

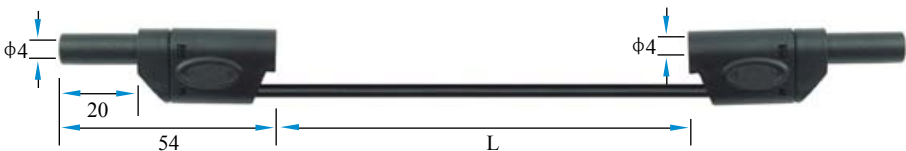

1 2 3 4 5 0

22.420.□*	Rated voltage/current: CATIII 600V-CATII 1000V/19A	1.0mm <sup>2</sup> PVC	025	050	100	CE
22.421.□*	Rated voltage/current: CATIII 600V-CATII 1000V/32A	2.5mm <sup>2</sup> PVC	025	050	100	CE
22.440.□*	Rated voltage/current: CATIII 600V-CATII 1000V/32A	2.5mm <sup>2</sup> SIL	025	050	100	CE



### 4mm Test Lead

Safety test lead with 4mm stackable plug on both ends. Nickel plated plugs with the shrinkable tube and red cap.

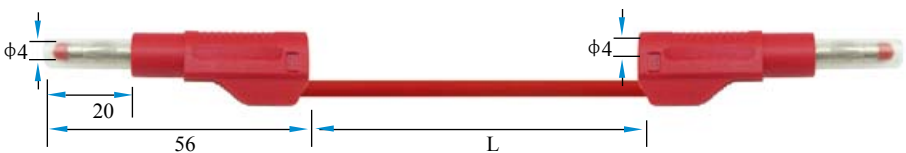

1 2 3 4 5

22.450.□*	Rated voltage/current: CATII 600V/19A	1.0mm <sup>2</sup> PVC	025	050	100	CE
22.451.□*	Rated voltage/current: CATII 600V/32A	2.5mm <sup>2</sup> PVC	025	050	100	CE
22.470.□*	Rated voltage/current: CATII 600V/32A	2.5mm <sup>2</sup> SIL	025	050	100	CE



### 4mm Test Lead

Safety test lead with 4mm stackable plug on both ends. Nickel plated plugs with the shrinkable tube and red cap.

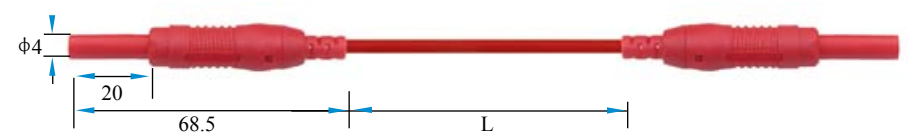

1 2 3 4 5

22.460.□*	Rated voltage/current: CATIII 1000V/19A	1.0mm <sup>2</sup> PVC	025	050	100	CE
22.461.□*	Rated voltage/current: CATIII 1000V/32A	2.5mm <sup>2</sup> PVC	025	050	100	CE
22.490.□*	Rated voltage/current: CATIII 1000V/19A	1.0mm <sup>2</sup> SIL	025	050	100	CE
22.491.□*	Rated voltage/current: CATIII 1000V/32A	2.5mm <sup>2</sup> SIL	025	050	100	CE



### 4mm Test Lead

Test lead with the injected 4mm stackable nickel plated plug on both ends.

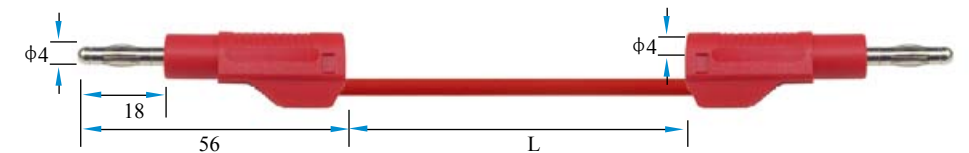

1 2 3 4 5

22.480.□*	Rated voltage/current: 30Vac-60Vdc/Max.15A	1.0mm <sup>2</sup> PVC	025	050	100
22.481.□*	Rated voltage/current: 30Vac-60Vdc/Max.15A	2.5mm <sup>2</sup> PVC	025	050	100
22.500.□*	Rated voltage/current: 30Vac-60Vdc/Max.32A	2.5mm <sup>2</sup> SIL	025	050	100

### 4mm Test Lead

Test lead one end with the 4mm stackable nickel plated plug and the other end with 55mm length nickel plated crocodile clip.

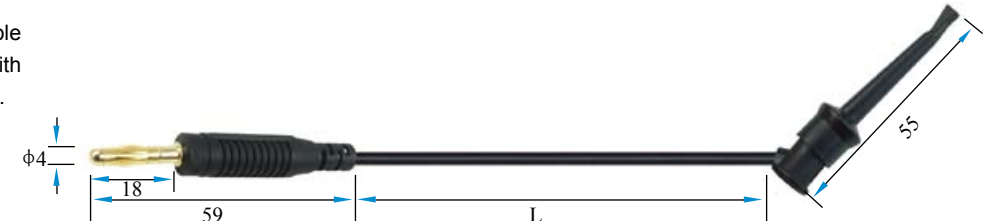

1 2 3 4 5

22.510.□*	Rated voltage/current: 30Vac-60Vdc/Max.15A	0.75mm <sup>2</sup> PVC	025	050	100
22.520.□*	Rated voltage/current: 30Vac-60Vdc/Max.15A	0.75mm <sup>2</sup> SIL	025	050	100

### 4mm Test Lead

Test lead one end with the 4mm stackable nickel plated plug and the other end with 55mm length nickel plated crocodile clip.

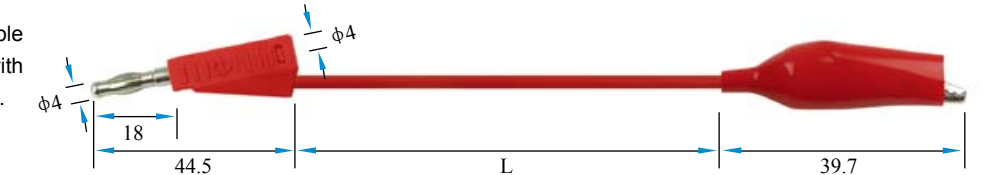

1 2 3 4 5

22.570.□*	Rated voltage/current: 30Vac-60Vdc/Max.15A	0.75mm <sup>2</sup> PVC	025	050	100
22.580.□*	Rated voltage/current: 30Vac-60Vdc/Max.15A	0.75mm <sup>2</sup> SIL	025	050	100

### 4mm Safety Test Lead

Safety test lead with the insulated 4mm stackable plug on both ends. Nickel plated plugs with the red cap.

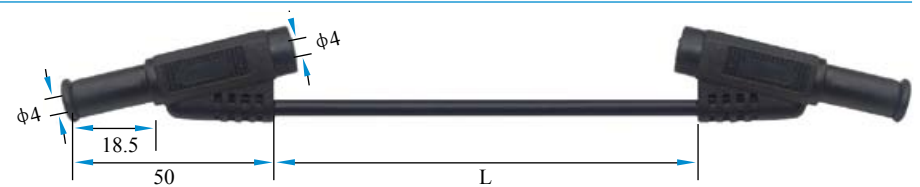

22.900.□*	Rated voltage/current: CATIII 1000V/15A	0.75mm <sup>2</sup> PVC	100	CE
22.901.□*	Rated voltage/current: CATIII 1000V/15A	1.0mm <sup>2</sup> PVC	100	CE



21.010



**Feature:** Insulated BNC Male to 2\*4mm straight safety plugs, connected with the flexible RG58/50Ω wire. L: 1.2M  
**Rating:** CATI 500V, CATII 150V/3A

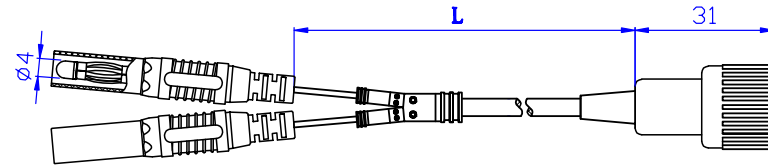

21.020



**Feature:** Insulated BNC Male to 2\*4mm stackable safety plugs, connected with the flexible RG58/50Ω wire. L: 1.2M  
**Rating:** CATI 500V, CATII 150V/3A

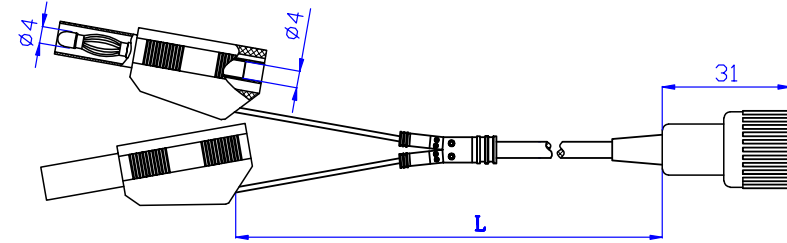

21.030



**Feature:** Insulated BNC Male to 2\*4mm stackable plugs, connected with the flexible RG58/50Ω wire. L: 1.2M  
**Rating:** CATI 500V, CATII 150V/3A

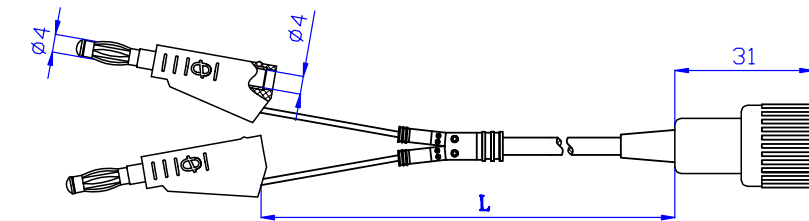

21.040



**Feature:** Insulated BNC Male to 2\*Mini test clips, connected with the flexible RG58/50Ω wire. L: 1.2M  
**Rating:** CATI 500V, CATII 150V/3A

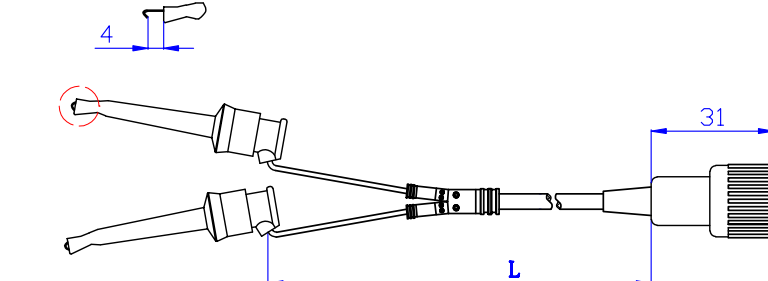

21.050



**Feature:** Insulated BNC Male to two crocodile clips, connected with the flexible RG58/50Ω wire. L: 1.2M  
**Rating:** CATI 500V, CATII 150V/3A

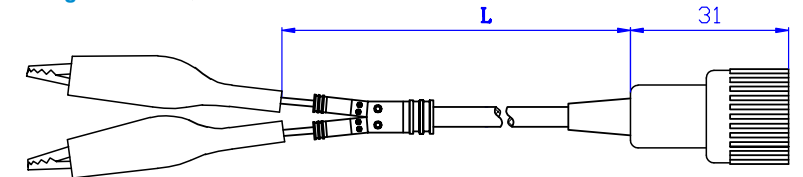

21.060



**Feature:** Insulated BNC Male at the each end, connected with the flexible RG58/50Ω wire. L: 1.0M  
**Rating:** CATI 500V, CATII 150V/3A

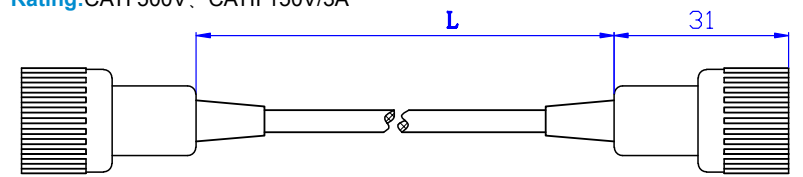

21.131

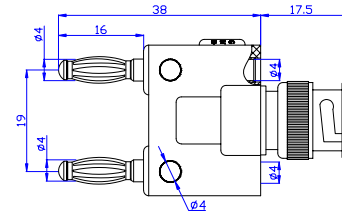

**Feature:** BNC Male with 2\*4mm Stackable Plug  
**Material:** Body: Brass; Spring: Beryllium copper; Surface: Nickel plated  
**Rating:** Maxium voltage for hands free use: 500Vrms

21.132

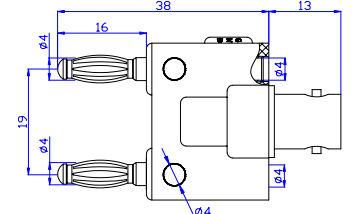

**Feature:** BNC Female with 2\*4mm Stackable Plug  
**Material:** Body: Brass; Spring: Beryllium copper; Surface: Nickel plated  
**Rating:** Maxium voltage for hands free use: 500Vrms

21.133

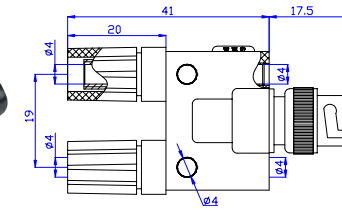

**Feature:** BNC Male with 2\*4mm Stackable Binding Post  
**Material:** Body: Brass; Surface: Nickel plated  
**Rating:** Maxium voltage for hands free use: 500Vrms

21.134

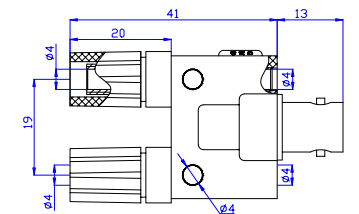

**Feature:** BNC Female with 2\*4mm Stackable Binding Post  
**Material:** Body: Brass; Surface: Nickel plated  
**Rating:** Maxium voltage for hands free use: 500Vrms

21.135

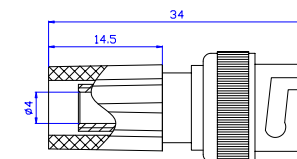

**Feature:** BNC Male with the Binding Post  
**Rating:** Maxium voltage for hands free use: 500Vrms



21.151



**Feature:** Safety BNC Male with 2x4mm Male Safety Socket  
**Material:**  
**Body:** Brass; Surface: Nickel plated  
**Rating:** CATI 500V, CATII 150V/3A

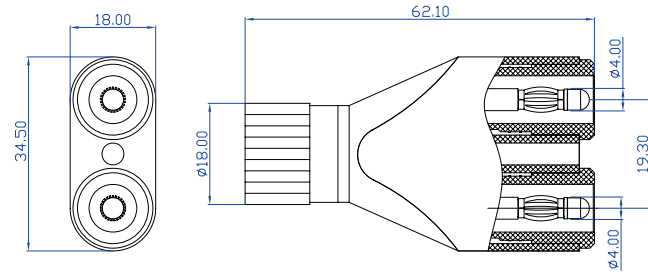

21.152



**Feature:** Safety BNC Male with 2x4mm Female Safety Socket  
**Material:**  
**Body:** Brass; Surface: Nickel plated  
**Rating:** CATI 500V, CATII 150V/3A

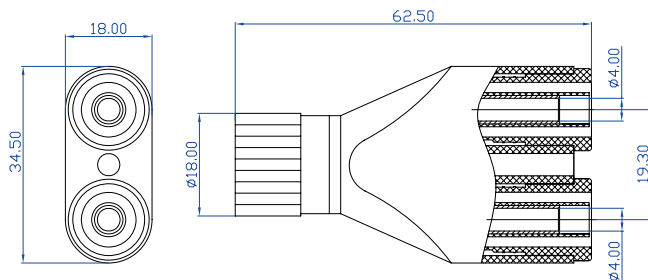

27.187. \*



**材质 Material**  
 塑壳 Insulator: PA  
 主体 Body: 铜 Brass  
 表面 Surface: 镀镍 Nickel plated  
**电气性能 Rated voltage/current**  
 30Vac-60Vdc/Max.10A

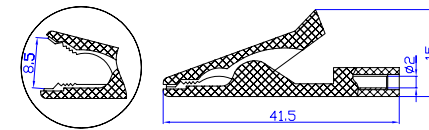

27.260. \*



**材质 Material**  
 塑壳 Insulator: PA  
 主体 Body: 铜 Brass  
 表面 Surface: 镀镍 Nickel plated  
**电气性能 Rated voltage/current**  
 CATII 300V/Max.15A

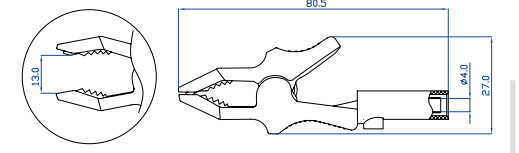

27.257. \*



**材质 Material**  
 塑壳 Insulator: PA  
 主体 Body: 铜 Brass  
 表面 Surface: 镀镍 Nickel plated  
**电气性能 Rated voltage/current**  
 CATII 300V/Max.15A

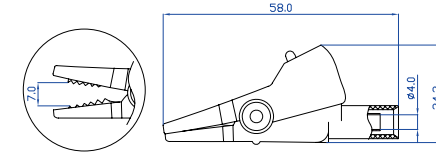

27.262. \*



**材质 Material**  
 塑壳 Insulator: PA  
 主体 Body: 铜 Brass  
 表面 Surface: 镀镍 Nickel plated  
**电气性能 Rated voltage/current**  
 CATIII 1000V/Max.32A

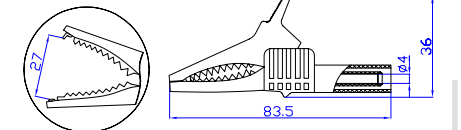

27.258. \*



**材质 Material**  
 塑壳 Insulator: PA  
 主体 Body: 铜 Brass  
 表面 Surface: 镀镍 Nickel plated  
**电气性能 Rated voltage/current**  
 CATII 300V/Max.15A

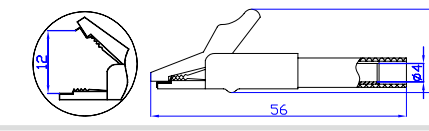

27.263. \*



**材质 Material**  
 塑壳 Insulator: PA  
 主体 Body: 铜 Brass  
 表面 Surface: 镀镍 Nickel plated  
**电气性能 Rated voltage/current**  
 CATIII 1000V/Max.32A

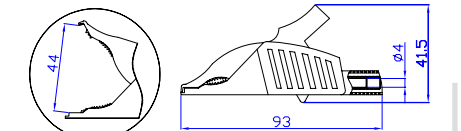

27.259. \*



**材质 Material**  
 塑壳 Insulator: ABS  
 主体 Body: 钢 Steel  
 表面 Surface: 镀镍 Nickel plated  
**电气性能 Rated voltage/current**  
 30Vac-60Vdc/Max.19A

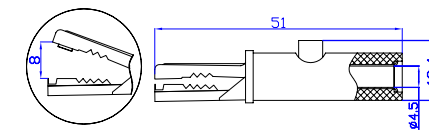

27.264. \*



**材质 Material**  
 塑壳 Insulator: PA  
 主体 Body: 铜 Brass  
 表面 Surface: 镀镍 Nickel plated  
**电气性能 Rated voltage/current**  
 CATIII 1000V/Max.32A

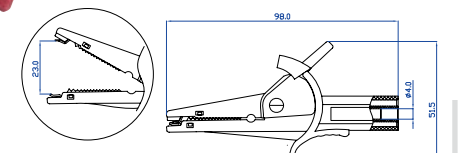

27.320.\*

**材质 Material**

塑壳 Insulator: ABS  
主体 Body: 铜 Brass  
表面 Surface: 镀金 Gold plated

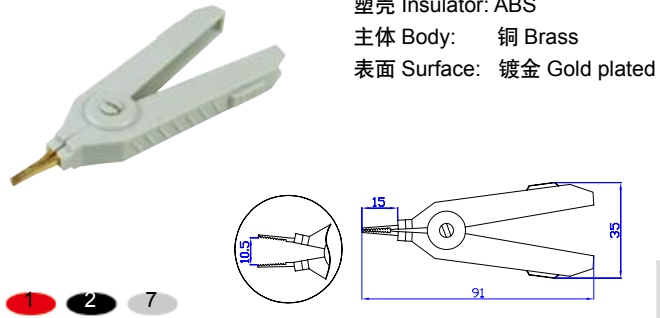

27.330.\*

**材质 Material**

塑壳 Insulator: PVC  
主体 Body: 铜 Brass  
表面 Surface: 镀镍 Nickel plated

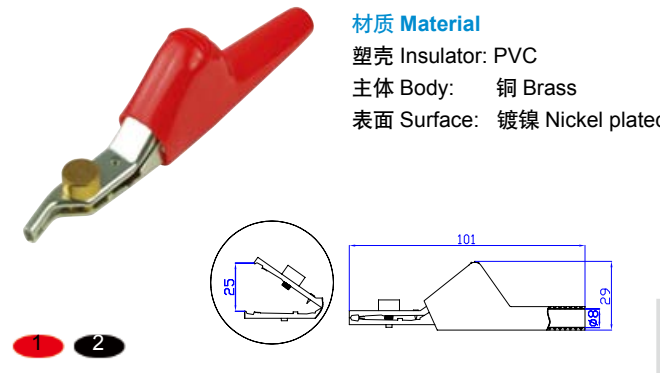

27.710/711/712.\*

**材质 Material**

塑壳 Insulator: PVC  
主体 Body: 钢 Steel  
表面 Surface: 镀镍 Nickel plated

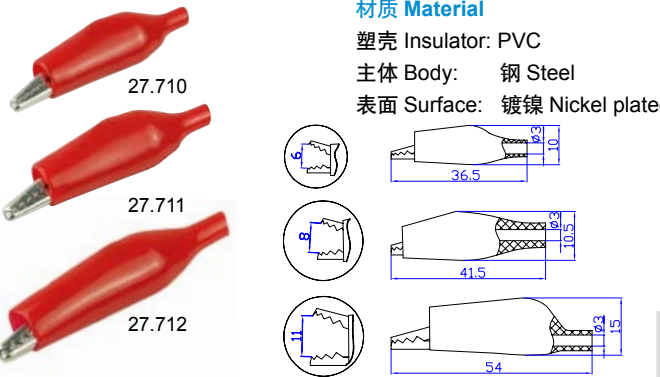

27.714.\*

**材质 Material**

塑壳 Insulator: PVC  
主体 Body: 钢 Steel  
表面 Surface: 镀镍 Nickel plated

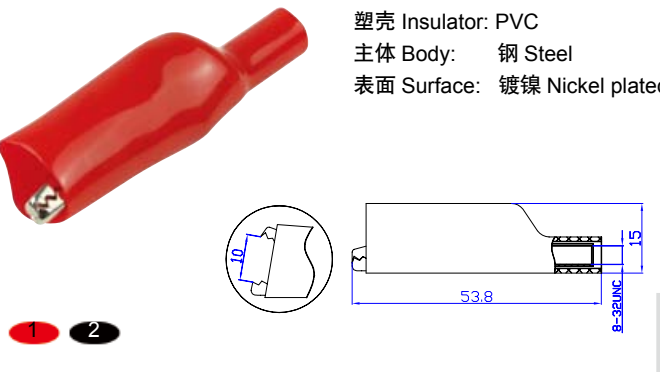

27.715.\*

**材质 Material**

塑壳 Insulator: ABS  
主体 Body: 钢 Steel  
表面 Surface: 镀镍 Nickel plated

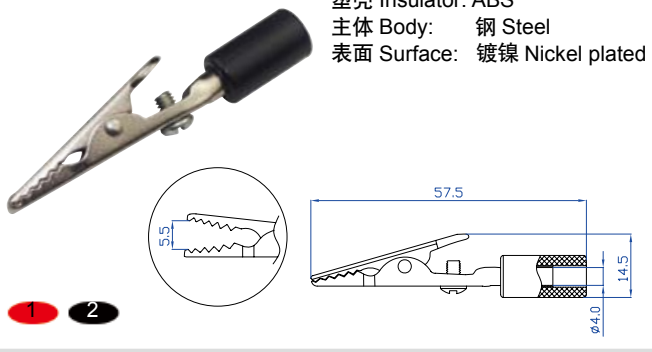

27.716.\*

**材质 Material**

主体 Body: 钢 Steel  
表面 Surface: 镀镍 Nickel plated  
电气性能 Rated voltage/current  
3Max.10A

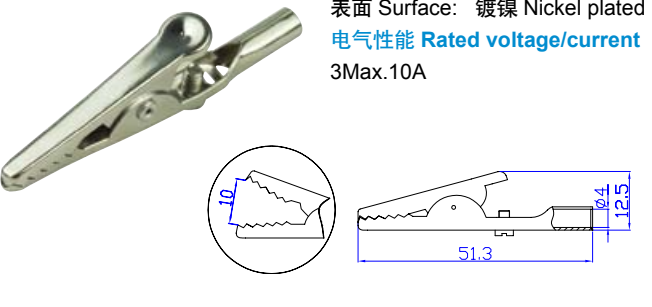

27.717.\*

**材质 Material**

塑壳 Insulator: ABS  
主体 Body: 钢 Steel  
表面 Surface: 镀镍 Nickel plated

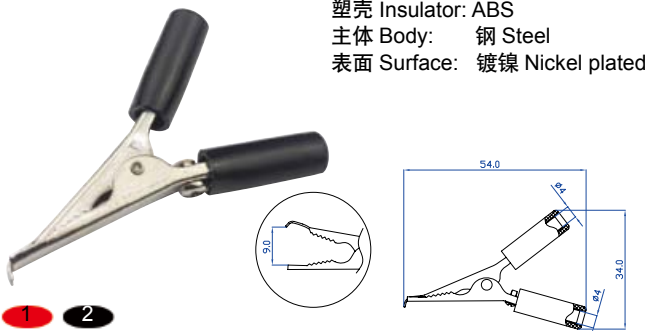

27.718.\*

**材质 Material**

塑壳 Insulator: PVC  
主体 Body: 钢 Steel  
表面 Surface: 镀镍 Nickel plated

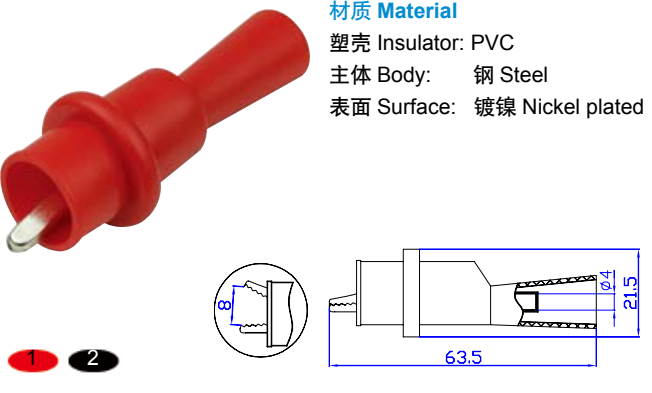

27.719.\*

**材质 Material**

塑壳 Insulator: ABS  
主体 Body: 钢 Steel  
表面 Surface: 镀镍 Nickel plated

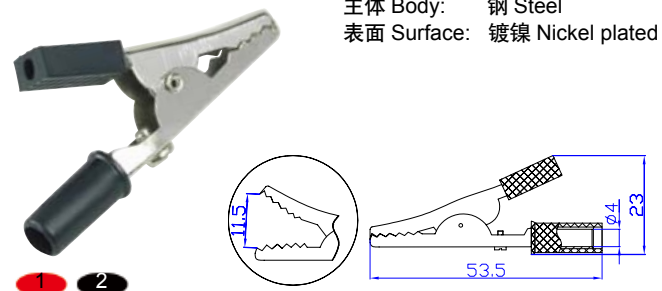

27.720.\*

**材质 Material**

塑壳 Insulator: PVC  
主体 Body: 钢 Steel  
表面 Surface: 镀镍 Nickel plated

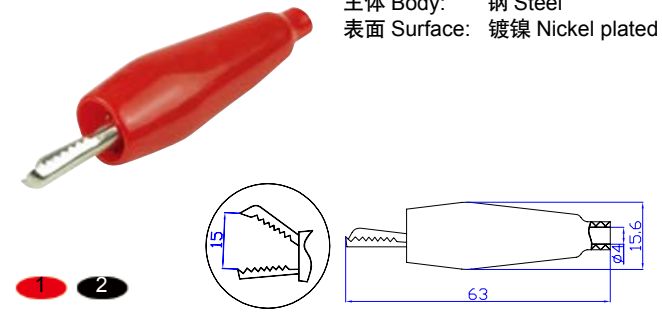

27.722.\*

**材质 Material**

塑壳 Insulator: PVC  
主体 Body: 钢 Steel  
表面 Surface: 镀镍 Nickel plated  
电气性能 Rated voltage/current  
Max.30A



27.723.\*

**材质 Material**

塑壳 Insulator: PVC  
主体 Body: 钢 Steel  
表面 Surface: 镀镍 Nickel plated  
电气性能 Rated voltage/current  
Max.30A

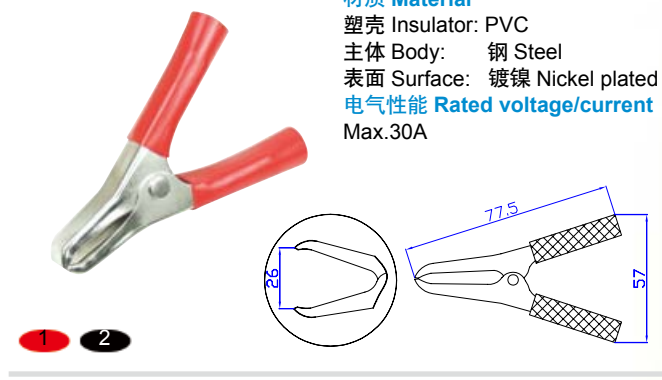

27.211.\*

**材质 Material**

塑壳 Insulator: PVC  
主体 Body: 钢 Steel  
表面 Surface: 镀镍 Nickel plated  
电气性能 Rated voltage/current  
Max.50A

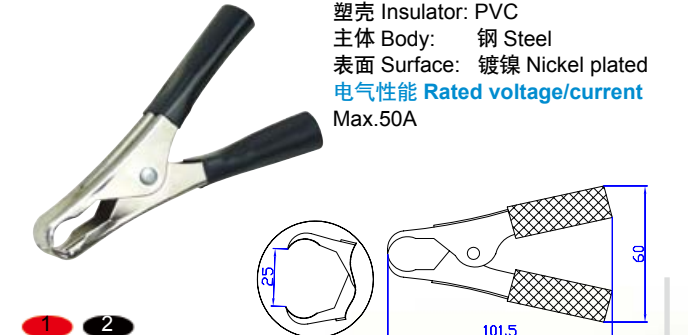



33.110



- 2 x 4mm safety test lead:22.420(1mm<sup>2</sup> JBF wire,L:100cm)
- 2 x test probe:20.164
- 2 x safety crocodile clips:27.262
- 2 x test clip:20.169

33.120



- 2 x 4mm safety test lead:22.420(1mm<sup>2</sup> JBF wire,L:100cm)
- 2 x test probe:20.164
- 2 x safety crocodile clips:27.262
- 2 x test probe:20.168

33.130



- 2 x 4mm safety test lead:22.310(1mm<sup>2</sup> JBF wire,L:100cm)
- 2 x test probe:20.164
- 2 x safety crocodile clips:27.262
- 2 x test clip:20.169

33.140



- 2 x 4mm safety test lead:22.280(1mm<sup>2</sup> JBF wire,L:100cm)
- 2 x test probe:20.157
- 2 x safety crocodile clips:27.262
- 2 x test clip:20.169

33.150



- 2 x 4mm safety test lead:22.280(1mm<sup>2</sup> JBF wire,L:100cm)
- 2 x 4mm test lead:22.530(0.75mm<sup>2</sup> PVC wire,L:25cm)
- 2 x test probe:20.157
- 2 x safety crocodile clips:27.262

33.310



- 2 x 4mm safety test lead:22.280(1mm<sup>2</sup> JBF wire,L:100cm)
- 2 x 4mm test lead:22.370(1mm<sup>2</sup> JBF wire,L:100cm)
- 2 x test probe:20.157
- 2 x safety crocodile clips:27.262
- 2 x test clip:20.169

★ Packed in the tool bag



33.320



- 2 x 4mm safety test lead:22.280(1mm<sup>2</sup> JBF wire,L:100cm)
- 2 x test probe:20.157
- 2 x test probe:20.164
- 2 x safety crocodile clips:27.262
- 2 x test clip:20.169
- 2 x connecting plug:26.451
- 2 x connecting plug:26.456

★ Packed in the tool bag



35.900



Choose the products from our catalogue and we will pack them into the tool bag as you want. Suitable for the small test kits with the test lead within 100CM.

- Feature:**
1. Five independent space of each bag
  2. Tool bag can hang on the wall or your belt
  3. Free logo space

35.910



Choose the products from our catalogue and we will pack them into the magic tool box as you want. Suitable for the medium test kits with the test lead within 200CM.

- Feature:**
1. Tool box can be divided into the different space with the plastic insert
  2. Tool bag can hang on the wall
  3. Free logo space

35.911



Choose the products from our catalogue and we will pack them into the magic tool box as you want. Suitable for the big test kits with the test lead within 500CM.

- Feature:**
1. Tool box can be divided into the different space with the plastic insert
  2. Tool bag can hang on the wall
  3. Free logo space

35.920



Choose the products from our catalogue and we will pack them into the tool box as you want. Suitable for the professional test kits.

- Feature:**
1. Special material to make the box that insure it can save in different working enviroment
  2. Foam-rubber cushion protect the inside products
  3. Free logo space

六角螺母 Hex nut

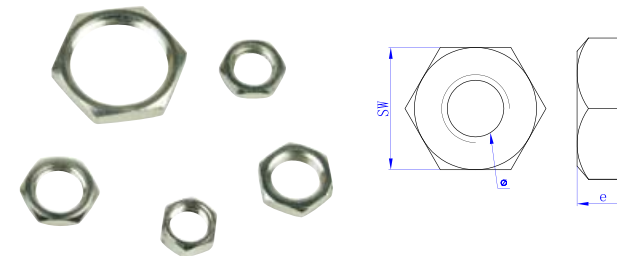

Item No.	T	e	sw
035.0005	M4	3	6
035.0010	M6	2	8
035.0014	M8	3	10
035.0023	M12	2.5	14

圆螺母 Round nut

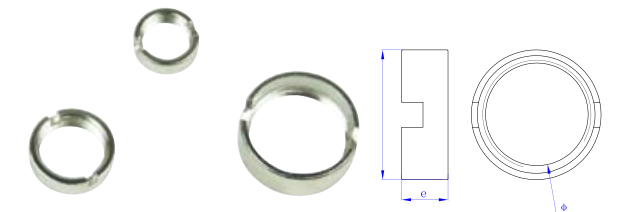

Item No.	T	e	φ
035.0039	M6	2.5	8
035.0029	M8	3	10
035.0030	M12	5	14

端子 Terminals

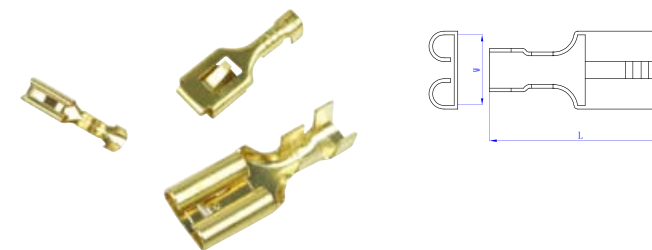

Item No.	W	L
023.0083	2.8	14
023.0084	4.8	15
023.0085	3.8	19

六角管 Hex spacers

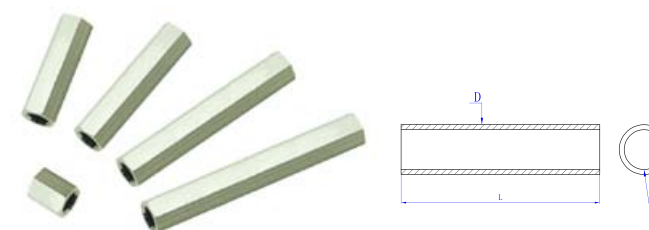

Item No.	φ	sw	L
023.0086	3	6	8
023.0087	3	6	20