



## Features

- Ideally suited for automatic insertion
- For switching and AF amplifier applications

## Package Marking and Ordering Information

Product ID	Pack	Marking	Qty(PCS)
BC846/BC847 /BC848	SOT-23	1x	3000

x: BC846A=A; BC846B=B; BC846C=C;  
BC847A=E; BC847B=F; BC847C=G;  
BC848A=J; BC848B=K; BC848C=L.

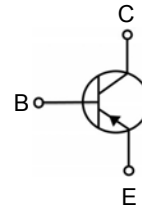
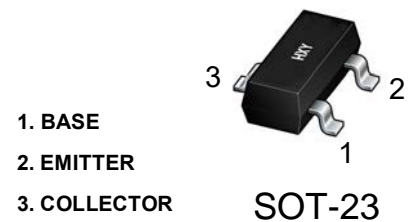

## Maxmim Ratings (Ta=25 unless otherwise noted)

Symbol	Parameter	Limit	Unit
$V_{CBO}$	Collector-Base Voltage	BC846 80	V
		BC847 50	
		BC848 30	
$V_{CEO}$	Collector-Emitter Voltage	BC846 65	V
		BC847 45	
		BC848 30	
$V_{EBO}$	Emitter-Base Voltage	6	V
$I_C$	Collector Current	100	mA
$P_C$	Collector Power Dissipation	200	mW
$R_{\theta JA}$	Thermal Resistance From Junction To Ambient	625	°C/W
$T_j$	Junction Temperature	150	°C
$T_{stg}$	Storage Temperature	-55~+150	°C



**Electrcal Characteristics (Ta=25 unless otherwise specified)**

Symbol	Parameter		Test conditions	Min	Max	Unit
$V_{(BR)CBO}$	Collector-base breakdown voltage	BC846 BC847 BC848	$I_C=10\mu A, I_E=0$	80 50 30		V
$V_{(BR)CEO}$	Collector-emitter breakdown voltage	BC846 BC847 BC848	$I_C=10mA, I_B=0$	65 45 30		V
$V_{(BR)EBO}$	Emitter-base breakdown voltage		$I_E=10\mu A, I_C=0$	6		V
$I_{CBO}$	Collector cut-off current	BC846 BC847 BC848	$V_{CB}=70V, I_E=0$ $V_{CB}=50V, I_E=0$ $V_{CB}=30V, I_E=0$		100	nA
$I_{EBO}$	Emitter cut-off current		$V_{EB}=5V, I_C=0$		100	nA
$h_{FE}$	DC current gain	BC846A BC847A BC848A BC846B BC847B BC848B BC846C BC847C BC848C	$V_{CE}=5V, I_C=2mA$	110 200 420	220 450 800	
$V_{CE(sat)}$	Collector-emitter saturation voltage		$I_C=100mA, I_B=5mA$		0.5	V
$V_{BE(sat)}$	Base-emitter saturation voltage				1.1	V
$f_T$	Transition frequency		$V_{CE}=5V, I_C=10mA,$ $f=30MHz$	100		MHz
$C_{ob}$	Collector output capacitance		$V_{CB}=10V, f=1MHz$		4.5	pF

**Typical Characteristics**

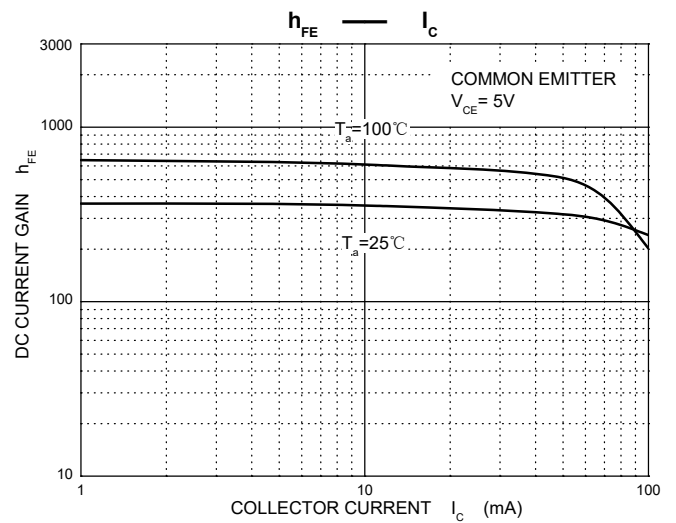
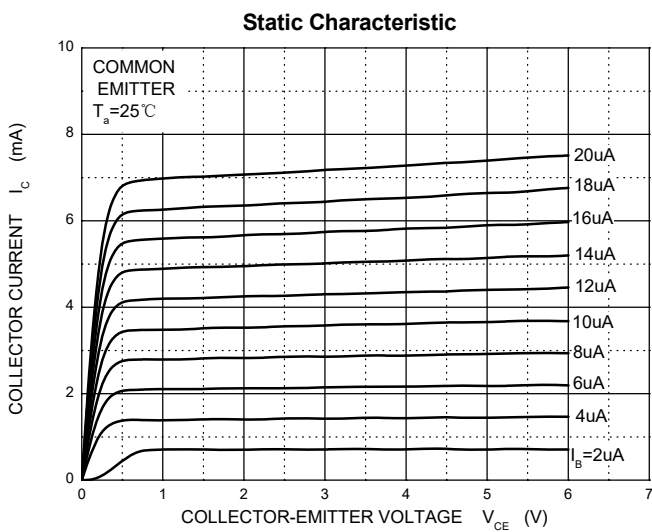

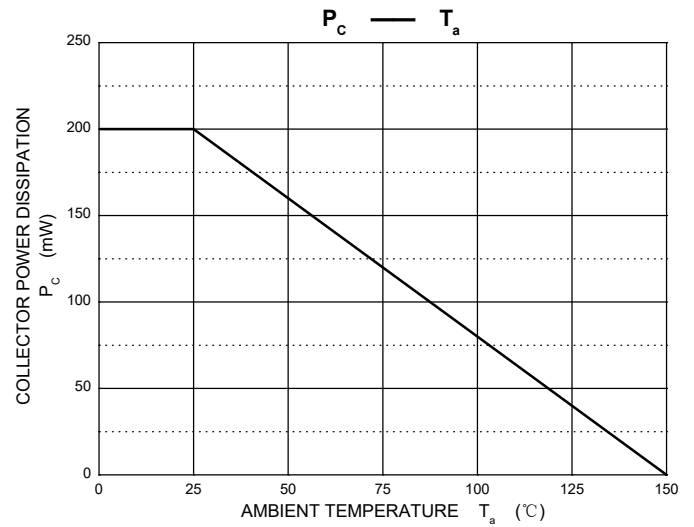
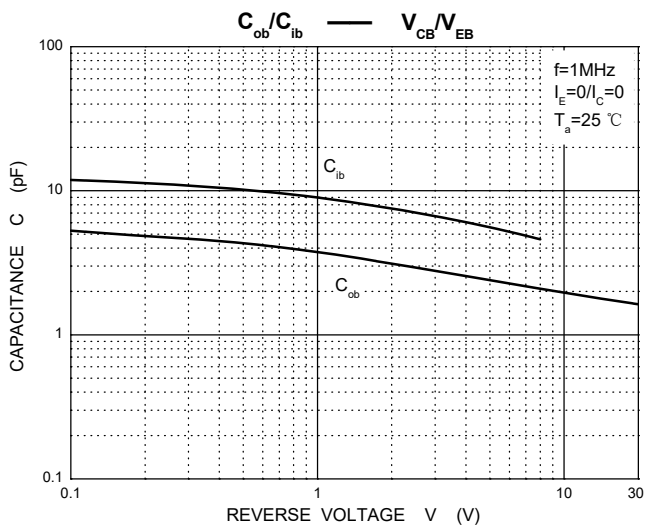
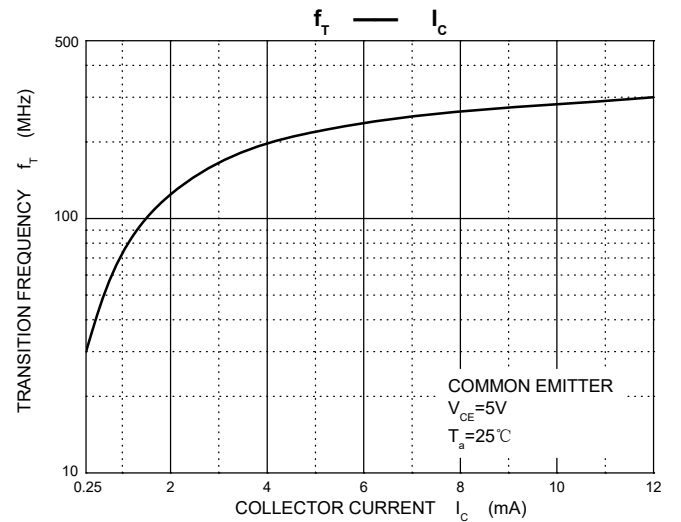
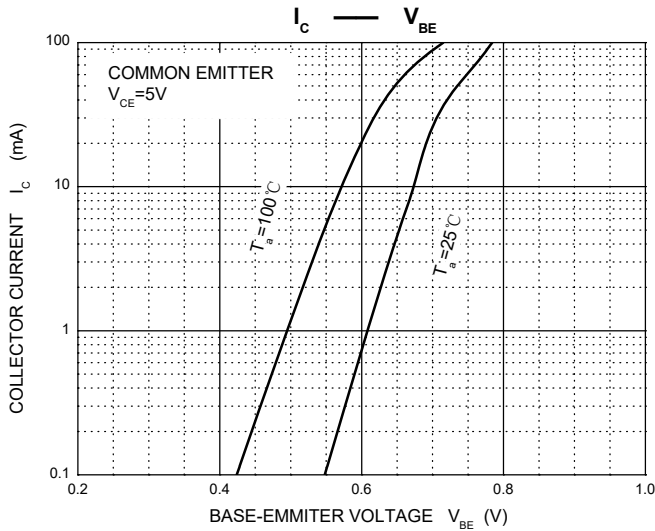
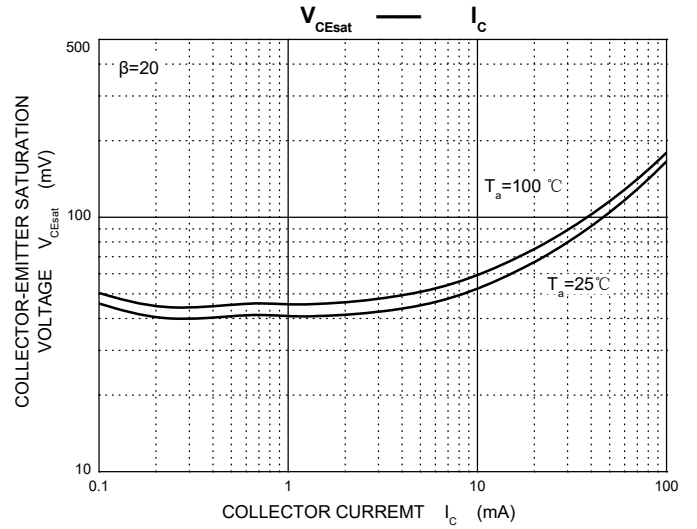
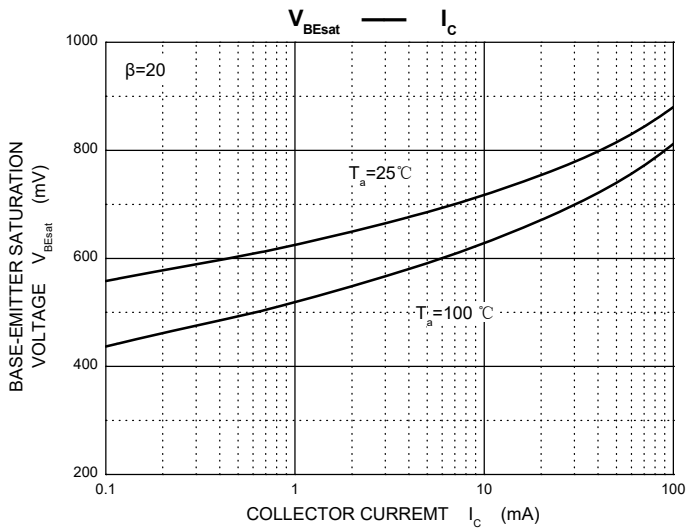



### SOT-23 Package Outline Dimensions

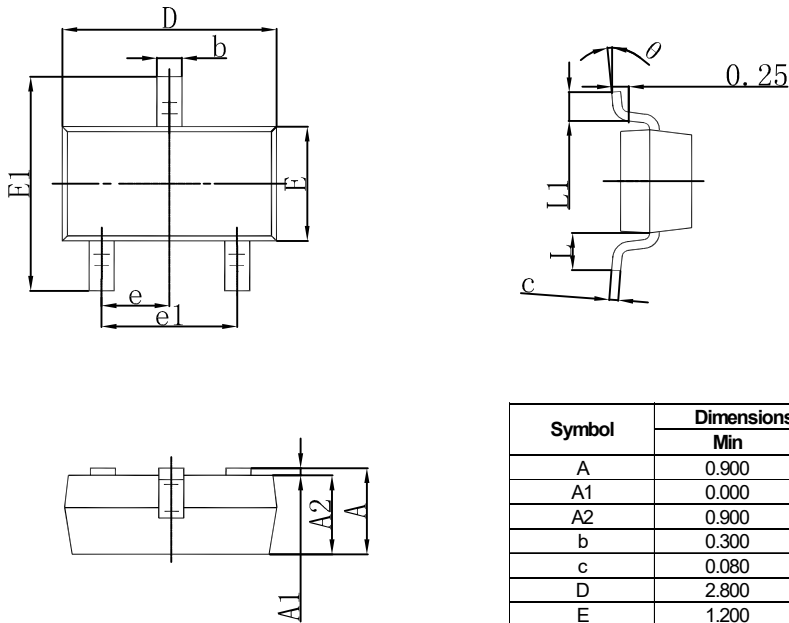

Symbol	Dimensions In Millimeters		Dimensions In Inches	
	Min	Max	Min	Max
A	0.900	1.150	0.035	0.045
A1	0.000	0.100	0.000	0.004
A2	0.900	1.050	0.035	0.041
b	0.300	0.500	0.012	0.020
c	0.080	0.150	0.003	0.006
D	2.800	3.000	0.110	0.118
E	1.200	1.400	0.047	0.055
E1	2.250	2.550	0.089	0.100
e	0.950 TYP		0.037 TYP	
e1	1.800	2.000	0.071	0.079
L	0.550 REF		0.022 REF	
L1	0.300	0.500	0.012	0.020
θ	0°	8°	0°	8°

### SOT-23 Suggested Pad Layout

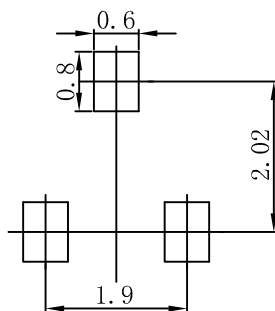

**Note:**

1. Controlling dimension: in millimeters.
2. General tolerance:  $\pm 0.05\text{mm}$ .
3. The pad layout is for reference purposes only.



### Attention

- Any and all HUA XUAN YANG ELECTRONICS products described or contained herein do not have specifications that can handle applications that require extremely high levels of reliability, such as life-support systems, aircraft's control systems, or other applications whose failure can be reasonably expected to result in serious physical and/or material damage. Consult with your HUA XUAN YANG ELECTRONICS representative nearest you before using any HUA XUAN YANG ELECTRONICS products described or contained herein in such applications.
- HUA XUAN YANG ELECTRONICS assumes no responsibility for equipment failures that result from using products at values that exceed, even momentarily, rated values (such as maximum ratings, operating condition ranges, or other parameters) listed in products specifications of any and all HUA XUAN YANG ELECTRONICS products described or contained herein.
- Specifications of any and all HUA XUAN YANG ELECTRONICS products described or contained herein stipulate the performance, characteristics, and functions of the described products in the independent state, and are not guarantees of the performance, characteristics, and functions of the described products as mounted in the customer's products or equipment. To verify symptoms and states that cannot be evaluated in an independent device, the customer should always evaluate and test devices mounted in the customer's products or equipment.
- HUA XUAN YANG ELECTRONICS CO.,LTD. strives to supply high-quality high-reliability products. However, any and all semiconductor products fail with some probability. It is possible that these probabilistic failures could give rise to accidents or events that could endanger human lives, that could give rise to smoke or fire, or that could cause damage to other property. When designing equipment, adopt safety measures so that these kinds of accidents or events cannot occur. Such measures include but are not limited to protective circuits and error prevention circuits for safe design, redundant design, and structural design.
- In the event that any or all HUA XUAN YANG ELECTRONICS products(including technical data, services) described or contained herein are controlled under any of applicable local export control laws and regulations, such products must not be exported without obtaining the export license from the authorities concerned in accordance with the above law.
- No part of this publication may be reproduced or transmitted in any form or by any means, electronic or mechanical, including photocopying and recording, or any information storage or retrieval system, or otherwise, without the prior written permission of HUA XUAN YANG ELECTRONICS CO.,LTD.
- Information (including circuit diagrams and circuit parameters) herein is for example only ; it is not guaranteed for volume production. HUA XUAN YANG ELECTRONICS believes information herein is accurate and reliable, but no guarantees are made or implied regarding its use or any infringements of intellectual property rights or other rights of third parties.
- Any and all information described or contained herein are subject to change without notice due to product/technology improvement, etc. When designing equipment, refer to the "Delivery Specification" for the HUA XUAN YANG ELECTRONICS product that you intend to use.