

## HX65HVD1040-S CAN Bus Transceiver

### General Description

The HX65HVD1040-S serves as the intermediary between the Controller Area Network (CAN) protocol controller and the physical bus, primarily designed for high-speed applications in passenger cars, with a maximum speed of up to 1 Mbaud. It facilitates differential transmission to the bus and differential reception for the CAN controller.

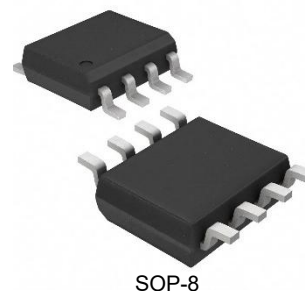

SOP-8

### Features

- Operating voltage range:  $VCC = 5V \pm 10\%$
- Fully compliant with the ISO 11898 standard
- High-speed operation (up to 1 Mbaud)
- Transceiver disengages from the bus in unpowered state (zero load)
- At least 110 nodes can be connected
- Very low-current standby mode with remote wake-up capability via the bus
- Differential receiver with high common-mode range for ElectroMagnetic Immunity (EMI)
- Transmit Data (TXD) dominant time-out function
- Bus pins protected against transients in automotive environments
- Thermally stabilized

### Applications

- Automotive electronics
- Security systems
- Industrial control automation
- Intelligent instrumentation
- Building automation systems
- Road traffic control automation
- Point-to-point and point-to-multipoint communications
- Level converter
- Serial servers

### PIN CONFIGURATIONS AND FUNCTIONS

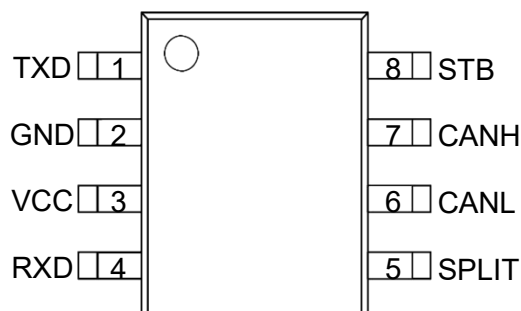

| Pin Descriptio |        |   |
|----------------|--------|---|
| Pin            | SYMBOL | Description   |
| 1              | TXD    | transmit data input                                       |
| 2              | GND    | ground supply   |
| 3              | VCC    | supply voltage, $VCC=5V \pm 10\%$                         |
| 4              | RXD    | receive data output; reads out data from the bus lines    |
| 5              | SPLIT  | common-mode stabilization output                          |
| 6              | CANL   | LOW-level CAN bus line                                    |
| 7              | CANH   | HIGH-level CAN bus line                                   |
| 8              | STB    | High speed and standby mode selection, low for high speed |

www.haixindianzi.com

## Absolute Maximum Rating

| SYMBOL            | PARAMETER                    | MIN  | MAX     | UNIT |
|-------------------|------------------------------|------|---------|------|
| VCC               | Supply voltage range         | 4.75 | 5.25    | V    |
| TXD, RXD, STB     | MCU Side Port                | -0.3 | VCC+0.3 | V    |
| CANL, CANH, SPLIT | Bus-side port voltage        | -60  | +60     | V    |
| Vtr               | Pin 6, 7 Transient Voltage   | -200 | +200    | V    |
|                   | storage temperature          | -55  | 150     | °C   |
|                   | ambient temperature          | -40  | 85      | °C   |
|                   | Welding temperature range    |      | 300     | °C   |
| SOP8              | Continuous power consumption |      | 400     | mW   |

## SPECIFICATIONS

(VCC=5V±10%, Temp=TMIN~TMAX, typical values at VCC=+5V, Temp=25°C, unless otherwise noted)

### Bus Transmitter DC Characteristics

| SYMBOL       | PARAMETER   | TESTCONDITIONS                  | MIN    | MAX  | UNIT   | SYMBOL |
|--------------|---|---------------------------------|--------|------|--------|--------|
| VOH(D)       | CANH output voltage (dominant)                              | VI=0V, STB=0V, RL=60Ω           | 2.9    | 3.4  | 4.5    |        |
| VOL(D)       | CANL output voltage (dominant)                              | F1、2                            | 0.8    |      | 1.5    |        |
| VO(R)        | Bus Output Differential Voltage(implicit)                   | VI=3V,STB=0V, RL=60Ω, F1、2      | 2      | 2.5  | 3      | V      |
| VOD(D)       | Bus Output Differential Voltage (dominant)                  | VI=0V,STB=0V, RL=60Ω, F1、2      | 1.5    |      | 3      | V      |
| VOD(R)       | Bus Output Differential Voltage (implicit)                  | VI=3V, S=0V, F1、2               | -0.012 |      | 0.012  | V      |
|              |   | VI=3V, STB=0V, NO LOAD          | -0.5   |      | 0.05   | V      |
| Vdom(TX)sym  | dominant output voltage symmetry                            | Vdom(TX)sym=VCC- VCANH<br>VCANL | -400   |      | 400    | mV     |
| VTXsym       | Output Voltage Symmetry                                     | VTXsym= VCANH + VCANL           | 0.9Vcc |      | 1.1Vcc | V      |
| VOC          | Common mode output voltage                                  | STB=0V, F 8                     | 2      | 2.5  | 3      | V      |
| ΔVOC         | Explicit and implicit common mode output voltage difference |                                 |        | 30   |        | mV     |
| IOS          | Short-circuit output current                                | CANH=-12V, CANL=open, F11       | -105   | -72  |        | mA     |
|              |   | CANH=12V, CANL=open, F11        |        | 0.36 | 1      |        |
|              |   | CANL=-12V, CANH=open, F11       | -1     | 0.5  |        |        |
|              |   | CANL=12V, CANH=open, F11        |        | 71   | 105    |        |
| IO(R)        | Hidden output current                                       | -27V<CANH<32V 0<VCC<5.25V       | -2.0   |      | 2.5    | mA     |
| VIL          | Low Level Input   |                                 |        | 0.36 | 1      |        |
| Ios<br>Io(R) | Short-circuit output current Hidden output current          | CANH=-12V, CANL=open, F 11      | -1     | 0.5  |        |        |
|              |   | CANH=12V, CANL=open, F 11       |        | 71   | 105    |        |
|              |   | -27V<CANH<32V 0<VCC<5.25V       | -2.0   |      | 2.5    | mA     |

### Bus Transmitter Switch Characteristic

|      |  |             |     |     |     |    |
|------|--|-------------|-----|-----|-----|----|
| tPLH | Transmission delay (low to high)         | STB=0V, F 4 | 25  | 65  | 120 | ns |
| tPHL | Transmission delay (high to low)         |             | 25  | 45  | 90  | ns |
| tr   | Differential output rise delay time      |             |     | 25  |     | ns |
| tf   | Differential output fall delay time      |             |     | 50  |     | ns |
| tEN  | Enable time from listen mode to dominant | F 7         |     |     | 10  | μs |
| tdom | Explicit timeout                         | F 10        | 300 | 450 | 700 | μs |
| tBUS | Bus wake-up time                         |             | 0.7 |     | 5   | μs |

| Bus Receiver DC Paramete           |   |                                      |        |     |         |        |
|------------------------------------|---|--------------------------------------|--------|-----|---------|--------|
| SYMBOL                             | PARAMETER   | TESTCONDITIONS                       | MIN    | MAX | UNIT    | SYMBOL |
| V <sub>IT+</sub>                   | Positive Input Threshold  | S=0V, F5                             |        | 800 | 900     | mV     |
| V <sub>IT-</sub>                   | Negative Input Threshold  |                                      | 500    | 650 |         |        |
| V <sub>HYS</sub>                   | Comparator Threshold Hysteresis Interval                            |                                      | 100    | 125 |         |        |
| V <sub>OH</sub>                    | High Level Output Voltage   | IO=-2mA, F6                          | 4      | 4.6 |         | V      |
| V <sub>OL</sub>                    | Low Level Output Voltage  | IO=2Ma,F6                            |        | 0.2 | 0.4     | V      |
| I <sub>(OFF)</sub>                 | Bus input current at power down                                     | CANH or CANL=5V,<br>Other pin=0V     |        |     | 5       | μA     |
| C <sub>I</sub>                     | CANH, CANL input capacitance to ground                              |                                      |        | 13  |         | pF     |
| C <sub>ID</sub>                    | CANH, CANL Differential Input Capacitors                            |                                      |        | 5   |         | pF     |
| R <sub>IN</sub>                    | CANH, CANL Input Resistance   | TXD=3V, STB=0V                       | 15     | 30  | 40      | KΩ     |
| R <sub>ID</sub>                    | CANH, CANL Differential Input Resistors                             |                                      | 30     |     | 80      | KΩ     |
| R <sub>I</sub> match               | RI(CANH), RIN(CANL) mismatches                                      | CANH=CANL                            | -3%    |     | 3%      |        |
| V <sub>COM</sub>                   | Common mode voltage range   |                                      | -12    |     | 12      | V      |
| Bus Receiver Switching Characteris |   |                                      |        |     |         |        |
| t <sub>PLH</sub>                   | Propagation delay (low to high)                                     | STB=0V or VCC F6                     | 60     | 100 | 130     | ns     |
| t <sub>PHL</sub>                   | Propagation delay (high to low)                                     |                                      | 45     | 70  | 90      | ns     |
| t <sub>r</sub>                     | RXD signal rise time  |                                      |        | 8   |         | ns     |
| t <sub>f</sub>                     | RXD signal fall time  |                                      |        | 8   |         | ns     |
| Device Switching Character         |   |                                      |        |     |         |        |
| T <sub>d</sub> (LOOP1)             | Loop delay 1, driver input to receiver output, implicit to explicit | STB=0V, F9                           | 90     |     | 190     | ns     |
| T <sub>d</sub> (LOOP2)             | Loop Delay 2, Driver Input to Receiver Output, Explicit to Implicit |                                      | 90     |     | 190     | ns     |
| Over-temperature protectio         |   |                                      |        |     |         |        |
| T <sub>j</sub> (sd)                | Over temperature shutdown   |                                      | 155    | 165 | 180     | ℃      |
| TXD Pin Characteristi              |   |                                      |        |     |         |        |
| V <sub>O</sub>                     | Common mode stabilised output voltage                               | -500uA<I <sub>o</sub> <500uA         | 0.3VCC |     | 0.7VCC  | V      |
| I <sub>O</sub> (stb)               | leakage current   | STB=2V,-12V<V <sub>O</sub> <12V      | -5     |     | 5       | μA     |
| I <sub>IH</sub> (TXD)              | TXD port high level input current                                   | V <sub>I</sub> =VCC                  | -2     |     | 2       | μA     |
| I <sub>IL</sub> (TXD)              | TXD Port Low Level Input Current                                    | V <sub>I</sub> =0                    | -50    |     | -10     | μA     |
| I <sub>O</sub> (off)               | Current in TXD when VCC=0V  | VCC=0V, TXD=5V                       |        |     | 1       | μA     |
| V <sub>IH</sub>                    | Input High LowerLimit   |                                      | 2      |     | VCC+0.3 | V      |
| V <sub>IL</sub>                    | Input Low Limit   |                                      | -0.3   |     | 0.8     | V      |
| TXD <sub>O</sub>                   | TXD Port Dangle Voltage   |                                      |        | H   |         | logic  |
| Power consumption characteristic   |   |                                      |        |     |         |        |
| I <sub>CC</sub>                    | Silent Mode Power Consumption                                       | STB=VCC, V <sub>I</sub> =VCC         |        | 5   | 12      | μA     |
|                                    | Dominant power consumption  | V <sub>I</sub> =0V, S=0V<br>LOAD=60Ω |        | 50  | 70      | mA     |
|                                    | Implicit power consumption  | V <sub>I</sub> =VCC, S=0V<br>NO LOAD |        | 6   | 10      | mA     |

| <b>Menu</b> (1)H=high; L=low; X=no care |                    |                    |                     |                     |           |                    |
|---|--------------------|--------------------|---------------------|---------------------|-----------|--------------------|
| <b>Table 1 CAN Transceiver Truth</b>    |                    |                    |                     |                     |           |                    |
| Vcc                                     | TXD <sup>(1)</sup> | STB <sup>(1)</sup> | CANH <sup>(1)</sup> | CANL <sup>(1)</sup> | BUS STATE | RXD <sup>(1)</sup> |
| 4.5V~5.5V                               | L                  | L                  | H                   | L                   | dominant  | L                  |
| 4.5V~5.5V                               | H (or float)       | X                  | 0.5VCC              | 0.5VCC              | implicit  | H                  |
| 4.5V~5.5V                               | X                  | H(or float)        | 0.5VCC              | 0.5VCC              | implicit  | <u>H</u>           |
| 0<VCC<4.5V                              | X                  | X                  | 0V<VCANH<VCC        | 0V<VCANL<VCC        | implicit  | X                  |

| <b>Table 2 Driver Function</b> |             |         |   |                     |
|--------------------------------|-------------|---------|---|---------------------|
| INPUTS                         |             | OUTPUTS |   | Bus State           |
| L                              | L           | H       | L | Dominate(dominant)  |
| H (or floa)                    | X           | Z       | Z | Recessive(implicit) |
| X                              | H(or float) | Z       | Z | Recessive(implicit) |

| <b>Table 3 Receiver Function</b> |                    |                          |
|----------------------------------|--------------------|--------------------------|
| VID=CANH-CANL                    | RXD <sup>(1)</sup> | Bus State <sup>(1)</sup> |
| VID≥0.9V                         | L                  | Dominate(dominant)       |
| 0.5< VID<0.9V                    |                    |                          |
| VID≤0.5V                         | H                  | Recessive (implicit)     |
| Open                             | H                  | Recessive (implicit)     |



**F1. Driver Voltage, Current Test Definitions**



**F2. Bus Logic Voltage Definition**

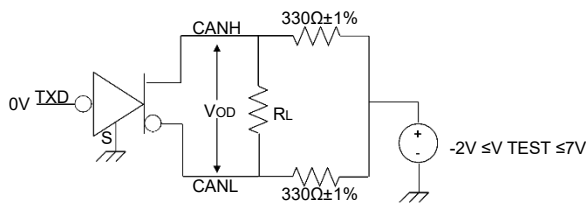

**F3. Driver VOD Test Circuit**

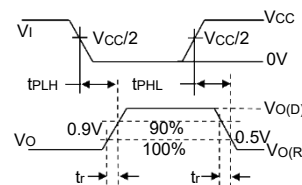
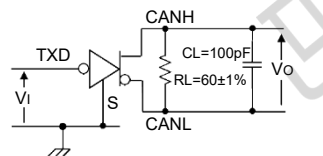

**F4. Driver Test Circuit and Voltage Waveforms**

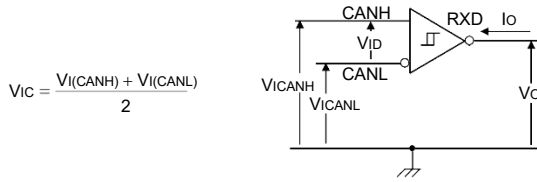

$$V_{IC} = \frac{V_I(CANH) + V_I(CANL)}{2}$$

**F5. Receiver Voltage and Current Definitions**

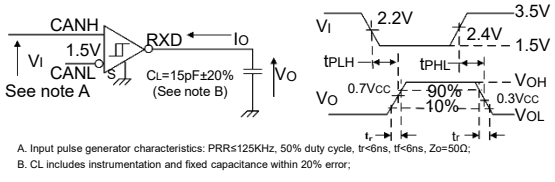

A. Input pulse generator characteristics: PRRs125KHz, 50% duty cycle,  $t_r < 6ns$ ,  $t_f < 6ns$ ,  $Z_o = 50\Omega$ ;  
B. CL includes instrumentation and fixed capacitance within 20% error;

**F6. Receiver test circuit and voltage waveform**

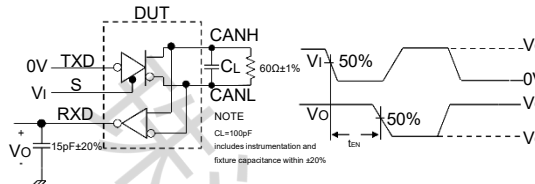

**F7. tEN Test Circuit and Voltage Waveforms**

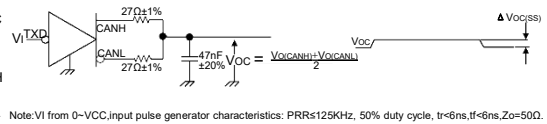

Note:  $V_I$  from 0-VCC input pulse generator characteristics: PRRs125KHz, 50% duty cycle,  $t_r < 6ns$ ,  $t_f < 6ns$ ,  $Z_o = 50\Omega$ .

**F8. Common Mode Output Voltage Test and Voltage Waveform**

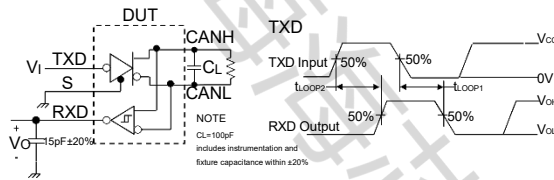

**F9. t(LOOP) Test Circuit and Waveforms**

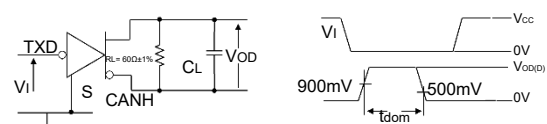

**F10. Revealed Timeout Test Circuit and Waveforms**

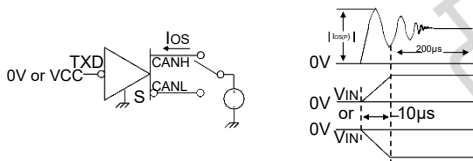

**F9. Driver Short Circuit Current Test Circuit and Waveforms**

## FUNCTIONAL BLOCK DIAGRAM

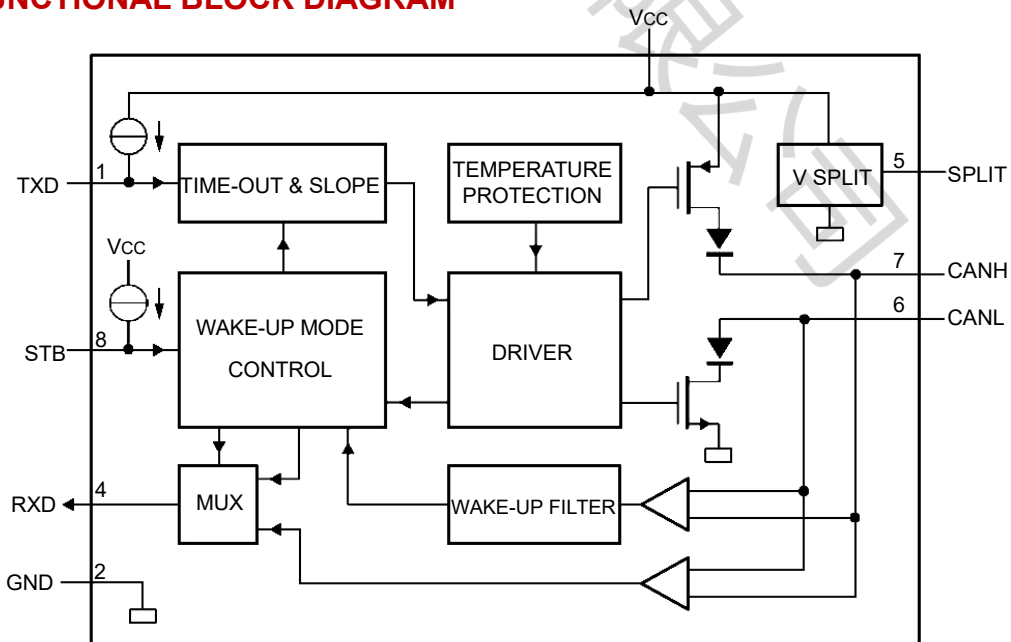

## DESCRIPTION

### Brief description

The HX65HVD1040-S is an interface chip that connects the CAN protocol controller with the physical bus. It can be used in trucks, buses, cars, industrial control, and other applications. With a data transmission rate of 1Mbps, the HX65HVD1040-S has the capability to transmit differential signals between the bus and the CAN protocol controller, fully compliant with the ISO 11898 standard.

### Short circuit protection

The HX65HVD1040-S's driver stage incorporates a current limit protection feature, designed to safeguard the circuit from shorts to the positive and negative supply voltages. In the event of a short-circuit, power consumption would rise, but thanks to the short-circuit protection function, the driver stage is protected from potential damage.

### Fail Safe

The TXD pin features a pull-up to VCC connection, ensuring that the bus remains in a recessive state when the TXD pin is not powered. The STB pin has a pull-up to VCC pass-through, ensuring that the transceiver remains in the standby state when the STB pin is not powered. In the event of a power supply drop, the TXD, STB, and RXD pins will become unconnected to prevent reverse power flow through these pins.

### Over Temperature Protection

The HX65HVD1040-S features an over-temperature protection function. When the junction temperature exceeds 160°C, the current of the driver stage is reduced. As the driver tube is the main energy-consuming component, reducing the current lowers power consumption, ultimately cooling the chip. Other parts of the chip continue to operate normally during this process.

### Significant Timeout Function

The TXD dominant timeout timer circuit is built-in to prevent the bus line from being driven to a permanently dominant state (blocking all network communications) if the TXD pin is forced permanently low due to a hardware or software application failure. The timer is triggered by a negative edge on the TXD pin.

If the low level on the TXD pin persists longer than the internal timer value ( $t_{dom}$ ), the transmitter is disabled, driving the bus into a recessive state. The timer is reset by a positive edge on the TXD pin.

### Control Modes

The control pin STB allows selection between two operation modes: high-speed mode and standby mode. In high-speed mode—the normal mode—the transceiver sends and receives data over the CANH and CANL buses by grounding the STB pin. In this mode, the differential receiver converts analogue data on the bus to digital data and outputs it via a multiplexer (MUX) to the RXD pin.

If the STB pin is left unconnected or connected to a high voltage level, it enters standby mode. In this mode, the transmitter and receiver are turned off, and the bus line is monitored by a low-power differential comparator. When a high voltage level is applied to the STB pin, it activates the low-power receiver and wake-up filter. As soon as the low-power differential comparator detects a dominant bus level above  $t_{BUS}$ , the RXD pin goes low.

## DIMENSIONAL DRAWINGS

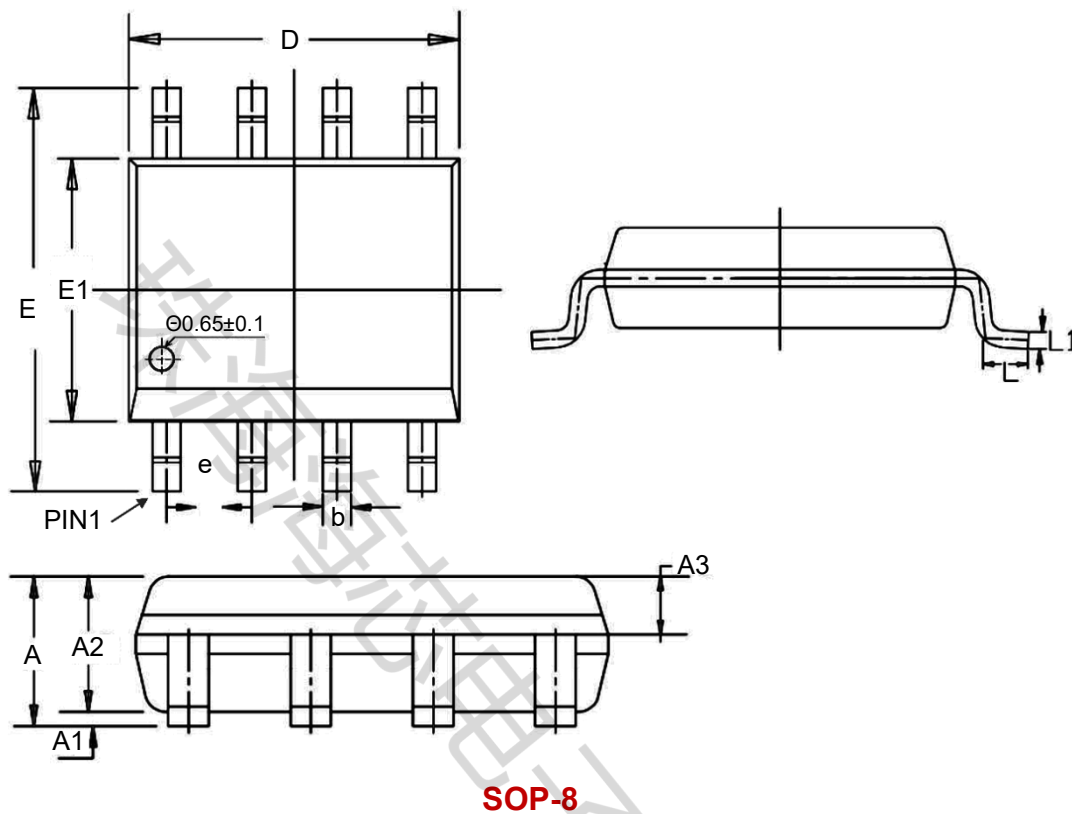

UNIT:mm

|    | MIN   | NOM     | MAX   |
|----|-------|---------|-------|
| A  | 1.450 | 1.550   | 1.650 |
| A1 | 0.100 | 0.150   | 0.200 |
| A2 | 1.300 | 1.400   | 1.500 |
| A3 | 0.600 | 0.650   | 0.700 |
| b  | 0.380 |         | 0.510 |
| e  | 1.240 | 1.270   | 1.300 |
| D  | 4.800 | 4.900   | 5.000 |
| E  | 5.800 | 6.000   | 6.200 |
| E1 | 3.800 | 3.900   | 4.000 |
| L  | 0.450 | 0.600   | 0.750 |
| L1 |       | 0.25BSC |       |

| Part Number   | Package Type | Package | quantity |
|---------------|--------------|---------|----------|
| HX65HVD1040-S | SOP-8        | Taping  | 2500     |

## Disclaimer

All products due to improve reliability, function or design or for other reasons, product specifications and data are subject to change without notice.

Zhuhai Haixin Electronics Co., Ltd., branches, agents, employees, and all persons acting on its or their representatives (collectively, the "zhuhai Haixindianzi"), assumes no responsibility for any errors, inaccuracies or incomplete data contained in the table or any other any disclosure of any information related to the product.([www.haixindianzi.com](http://www.haixindianzi.com))

Zhuhai Haixin makes no guarantee, representation or warranty on the product for any particular purpose of any goods or continuous production. To the maximum extent permitted by applicable law on Zhuhai Haixin relinquished: (1) any application and all liability arising out of or use of any products; (2) any and all liability, including but not limited to special, consequential damages or incidental ; (3) any and all implied warranties, including a particular purpose, non-infringement and merchantability guarantee.

Statement on certain types of applications are based on knowledge of the product is often used in a typical application of the general product Haixin Zhuhai demand that the Zhuhai Haixin of. Statement on whether the product is suitable for a particular application is non-binding. It is the customer's responsibility to verify specific product features in the products described in the specification is appropriate for use in a particular application. Parameter data sheets and technical specifications can be provided may vary depending on the application and performance over time. All operating parameters, including typical parameters must be made by customer's technical experts validated for each customer application. Product specifications do not expand or modify Zhuhai Haixin purchasing terms and conditions, including but not limited to warranty herein.

Unless expressly stated in writing, Zhuhai Haixin products are not intended for use in medical, life saving, or life sustaining applications or any other application. Wherein Haixin product failure could lead to personal injury or death, use or sale of products used in Zhuhai Haixin such applications using client did not express their own risk. Contact your authorized Zhuhai Haixin people who are related to product design applications and other terms and conditions in writing.

The information provided in this document and the company's products without a license, express or implied, by estoppel or otherwise, to any intellectual property rights granted to the Haixin act or document. Product names and trademarks referred to herein are trademarks of their respective representatives will be all.