

5.5V, 2.3MHz, 2A Synchronous Step-Down Converter with Small DFN1.6x1.6-6 Package

FEATURES

- High Efficiency: Up to 95% (@3.3V_{OUT})
- 2.3MHz Switching Frequency Operation
- Up to 2A Output Current
- 2.5V to 5.5V Input Voltage Range
- Output Voltage as Low as 0.6V
- PFM Mode for High Efficiency in Light Load
- 100% Duty Cycle in Dropout Operation
- Low Quiescent Current: 40µA
- Short Hiccup Protection
- Thermal Fault Protection
- Inrush Current Limit and Soft Start
- Input over voltage protection (OVP)
- <1µA Shutdown Current
- DFN1.6x1.6-6 Package

APPLICATIONS

- Set Top Box
- Wireless and DSL Modems
- Portable Instruments
- Digital Still and Video Cameras
- PC Cards

GENERAL DESCRIPTION

The TMI31602H is a 2.3MHz switching frequency, current mode step-down converter. It is ideal for portable equipment requiring very high current up to 2A from single-cell Lithium-ion batteries or other input source from 2.5V to 5.5V input voltage and the output voltage can be regulated as low as 0.6V. The TMI31602H also can run at 100% duty cycle for low dropout operation, extending battery life in portable systems while light load operation provides very low output ripple for noise sensitive applications. The high switching frequency minimizes the size of external components while keeping switching losses low. The internal slope compensation setting allows the device to operate with smaller inductor values to optimize size and provide efficient operation. The TMI31602H adopts small size DFN1.6x1.6-6 package.

This device offers two operation modes, PWM control and PFM Mode switching control, which allows a high efficiency over the wider range of the load.

TYPICAL APPLICATION

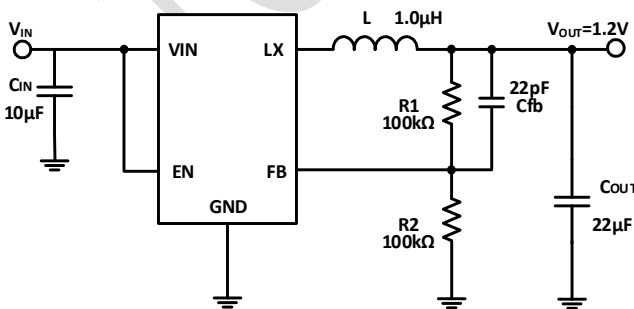
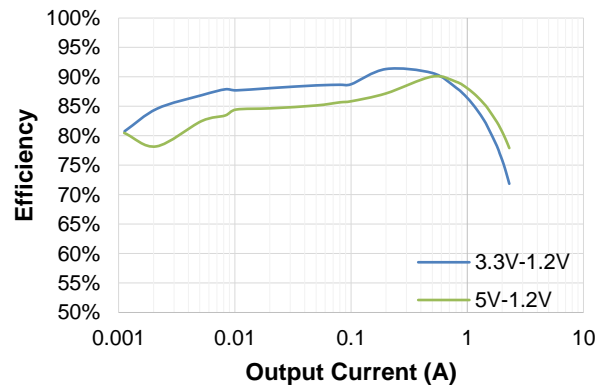

Figure 1. Basic Application Circuit

Efficiency

V_{OUT}=1.2V, L=1.0µH, T_A=25°C, I_O=10mA to 2A



ABSOLUTE MAXIMUM RATINGS (Note 1)

Parameter	Min	Max	Unit
Input Supply Voltage	-0.3	6.5	V
LX Voltages	-0.3	6.5	V
LX Voltage (<10ns transient)	-2.5	7.0	V
LX Voltage (<5ns transient)	-3.5	7.5	V
EN, PG, FB Voltage	-0.3	6.5	V
Storage Temperature Range	-65	150	°C
Junction Temperature (Note2)	-	150	°C
Power Dissipation	-	600	mW
Lead Temperature (Soldering, 10s)	-	260	°C

PACKAGE/ORDER INFORMATION

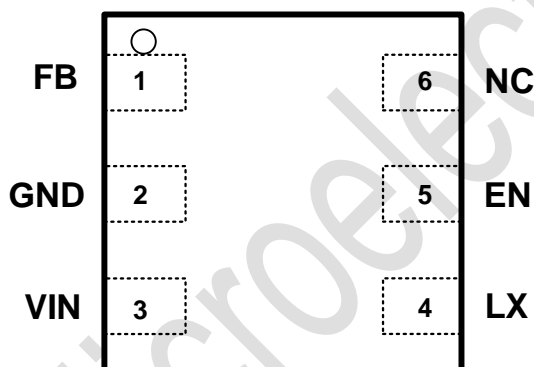

DFN1.6x1.6-6
(Top View)

Top Mark: TDH/xxx (TDH: Device Code, xxx: Inside Code)

Part Number	Package	Top Mark	Quantity/ Reel
TMI31602H	DFN1.6x1.6-6	TDH xxx	3000

TMI31602H devices are Pb-free and RoHS compliant.

PIN DESCRIPTION

Pin	Name	Function
1	FB	Output Voltage Feedback Pin. It is connected to feedback divider resistor.
2	GND	Ground Pin
3	VIN	Power Supply Input. Must be closely decoupled to GND with a 10 μ F or greater ceramic capacitor.
4	LX	Power Switch Output. It is the switch node connection to Inductor.
5	EN	Chip Enable Pin. Drive EN above EN high threshold to turn on the part. Drive EN below EN low threshold to turn it off. Do not leave EN floating.
6	NC	No Internal Connection.

ESD RATING

Items	Description	Value	Unit
V _{ESD_HBM}	Human Body Model for all pins	± 2000	V
V _{ESD_CDM}	Charge Device Model for all pins	± 1000	V

JEDEC specification JS-001

RECOMMENDED OPERATING CONDITIONS

Items	Description	Min	Max	Unit
Voltage Range	IN	2.5	5.5	V
T _J	Operating Junction Temperature Range	-40	125	°C

THERMAL RESISTANCE (Note 3)

Items	Description	Value	Unit
θ_{JA}	Junction-to-ambient thermal resistance	140	°C/W
θ_{JC}	Junction-to-case thermal resistance	62	°C/W

ELECTRICAL CHARACTERISTICS

(V_{IN}=V_{EN}=3.6V, V_{OUT}=1.8V, T_A = 25°C, unless otherwise noted.)

Parameter	Test Conditions	Min	Typ	Max	Unit
Input Voltage Range		2.5		5.5	V
Input OVP Threshold	V _{IN} rising		5.9	6.1	V
UVLO Threshold	V _{IN} rising	2.2	2.35	2.5	V
UVLO Hysteresis			0.4		V
Quiescent Current	V _{EN} =2.0V, I _{OUT} =0A, V _{FB} =V _{REF} X 105%		40	100	μA
Shutdown Current	V _{EN} =0V		0.2	1.0	μA
Feedback Voltage Accuracy	T _A = 25°C, PWM Operation	0.588	0.600	0.612	V
Oscillation Frequency	V _{OUT} =100%	2.0	2.3	2.7	MHz
	V _{OUT} =0V, During Hiccup Mode		350		kHz
On Resistance of PMOS	I _{LX} =100mA		120		mΩ
On Resistance of NMOS	I _{LX} =-100mA		70		mΩ
Peak Current Limit	V _{IN} =5V, V _{OUT} =90%		2.7		A
Soft Start Time			0.8		ms
EN Rising Threshold	V _{IN} =5V	0.9	1.15	1.4	V
	V _{IN} =3.3V	0.75	1.0	1.25	V
EN Falling Threshold	V _{IN} =5V	0.75	1.0	1.25	V
	V _{IN} =3.3V	0.65	0.9	1.15	V
EN Leakage Current				1.0	μA
LX Leakage Current	V _{EN} =0V, V _{IN} =V _{LX} =5V			1.0	μA
Thermal Shutdown Threshold (Note 4)			150		°C
Thermal Shutdown Hysteresis (Note 4)			20		°C

Note 1: Absolute Maximum Ratings are those values beyond which the life of a device may be impaired.

Note 2: T_J is calculated from the ambient temperature T_A and power dissipation P_D according to the following formula: T_J = T_A + (P_D) × θ_{JA}.

Note 3: Measured on JESD51-7, 4-layer PCB.

Note 4: Thermal shutdown threshold and hysteresis are guaranteed by design.

FUNCTION DESCRIPTION

Overview

The TMI31602H is a high output current switch mode step-down DC-DC converter. The device operates at 2.3MHz switching frequency, and uses a slope compensated current mode architecture. This step-down DC-DC converter can supply up to 2A output current at $V_{IN}=5V$ and has an input voltage range from 2.5V to 5.5V. It minimizes external component size and optimizes efficiency at the heavy load range. The slope compensation allows the device to remain stable over a wider range of inductor values so that smaller values with lower DCR can be used to achieve higher efficiency. Only a small bypass input capacitor is required at the output.

In light and no-load condition, TMI31602H are operating in PFM mode for power saving. In PFM mode, the device ramps up its output voltage with several SW switching pulse, while the error amplifier output voltage V_{COMP} drops. The device stops switching when V_{COMP} voltage drops down the inner threshold, so the FB voltage in PFM mode is a little bit higher than normal 0.6V reference voltage in PWM operation.

The adjustable output voltage can be programmed with external feedback dividers, ranging from 0.6V to near the input voltage. It uses internal MOSFETs to achieve high efficiency and can generate very low output voltages by using an internal reference of 0.6V. At dropout operation, the converter duty cycle increases to 100% and the output voltage tracks the input voltage minus the low $R_{DS(ON)}$ drop of the P-channel high-side MOSFET and the inductor DCR. The internal error amplifier and compensation provides excellent transient response, load and line regulation. Internal soft start eliminates any output voltage overshoot when the device is enabled or the input voltage is applied.

Input Over Voltage Protection

TMI31602H has input side over voltage protection function. When input voltage is higher than input OVP threshold 5.9V typical, TMI31602H stops switching operation to protect device works with high input voltage. When input voltage is recovered from OVP and drops down input OVP threshold with OVP hysteresis typical 140mV, the device starts to switch as normal operation automatically. This function protects device from switching in abnormal high input voltage and input surge condition.

Input Under Voltage Lockout

TMI31602H implements input under voltage lockout function to avoid mis-operation at low input voltages. When the input voltage is lower than input UVLO threshold with UVLO hysteresis, the device is shut down. The typical 400mV input UVLO hysteresis value of TMI31602H is useful to prevent device from abnormal switching caused by input voltage oscillation around UVLO threshold during input voltage power-up and power-down with high load condition.

Soft Start

TMI31602H has built-in soft-start circuits to control output voltage rise rate to avoids excessive inrush current during IC start up. The typical soft-start time is 0.8ms.

Over Current Limit and Output Short Protection

TMI31602H has high side switching current limit function and prevents the device from high load current condition. The typical high side peak current limit value is 2.7A. When output load current increases and inductor current peak value reaches peak current limit value, high side MOSFET is turned off immediately and the output voltage drops down according to load condition. If output voltage keeps falling down, once the V_{FB} voltage is lower than 200mV typical, the device enters into output short hiccup protection condition in order to reduce power consumption and device thermal rise in the condition of output short to GND. In output short hiccup protection condition, the device hiccup cycle period is 16ms typical and the switching operation time during hiccup mode is 2ms. the switching frequency during hiccup mode is 350kHz.

Thermal Shutdown

TMI31602H enters into thermal shutdown once the junction temperature exceeds thermal shutdown threshold 150°C typically. Once the device junction temperature falls below the threshold with hysteresis, TMI31602H returns to normal operation automatically.

FUNCTIONAL BLOCK DIAGRAM

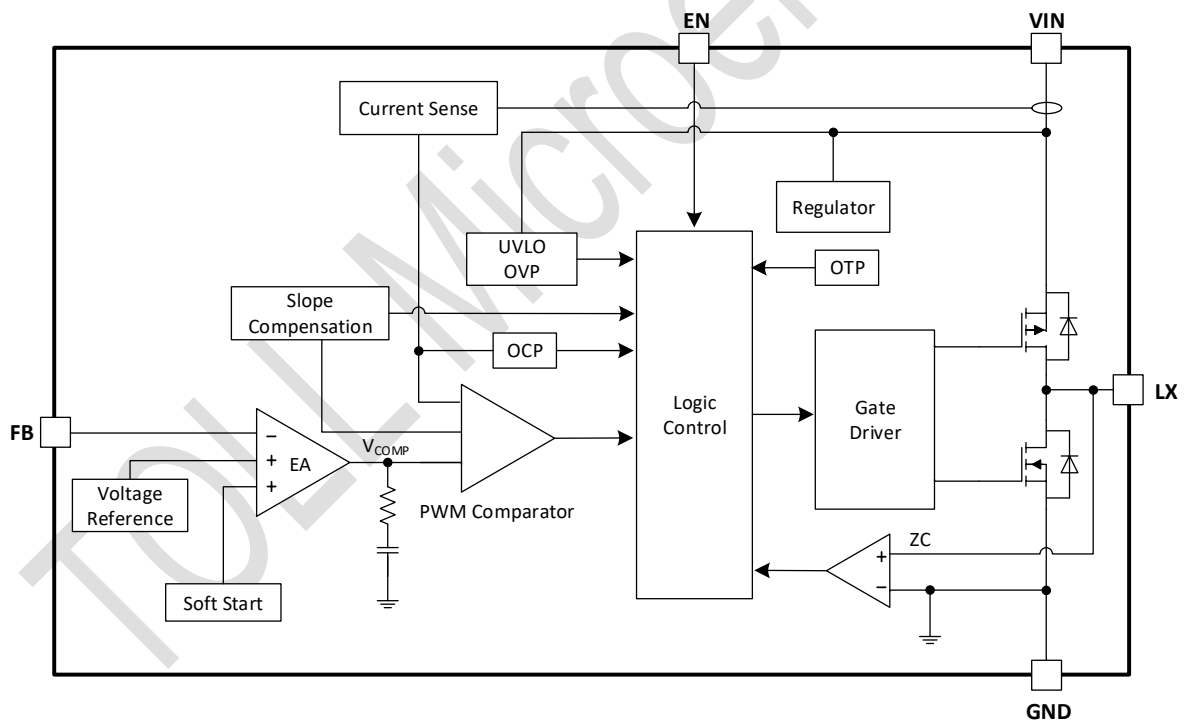

Figure 2. TMI31602H Block Diagram

TYPICAL PERFORMANCE CHARACTERISTICS °C

Test condition: $V_{IN}=5V$, $V_{OUT}=1.2V$, $L=1.0\mu H$, $T_A=+25^\circ C$, unless other noted.

Efficiency at $V_{IN} = 5V$

$V_{IN} = 5V$, $L=1\mu H$, $DCR=20m\Omega$

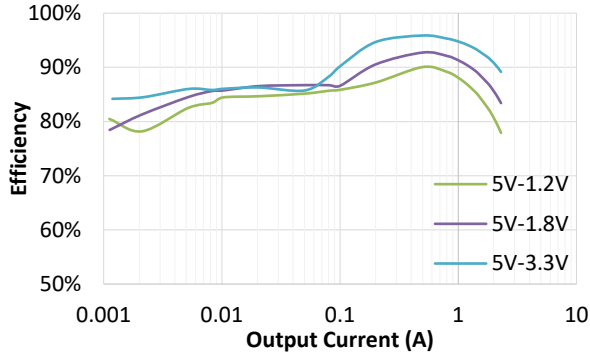

Efficiency at $V_{IN} = 3.3V$

$V_{IN} = 3.3V$, $L=1\mu H$, $DCR=20m\Omega$

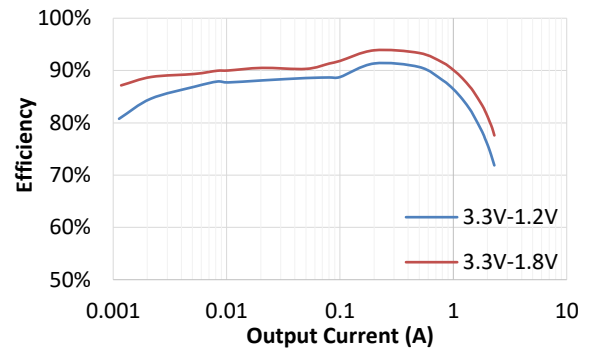

Line Regulation at $V_{OUT}=1.2V$

$V_{OUT}=1.2V$, $T_A=25^\circ C$

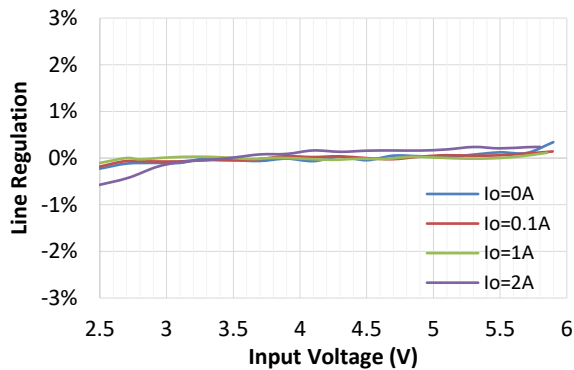

Load Regulation at $V_{IN} = 5V$

$V_{IN}=5V$, $T_A=25^\circ C$

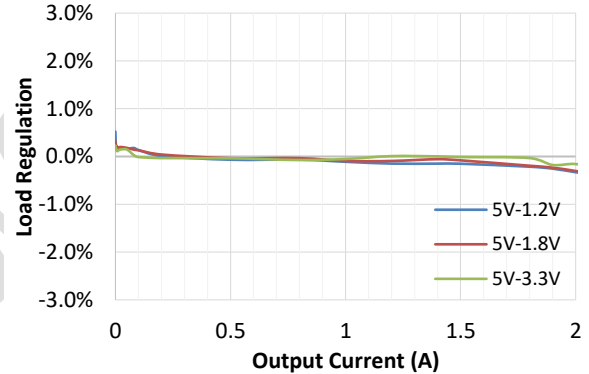

Steady State Operation

$V_{IN} = 5V$, $V_{OUT} = 1.2V$, No Load

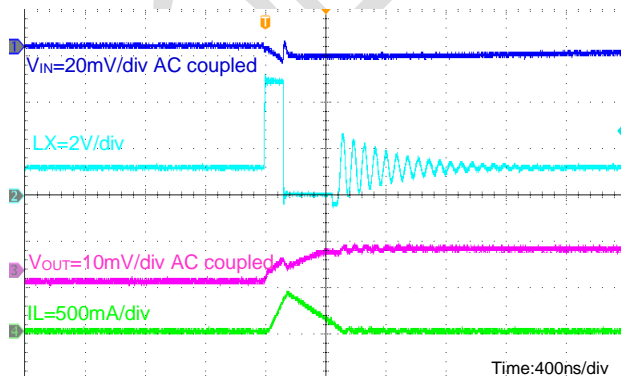

Steady State Operation

$V_{IN} = 5V$, $V_{OUT} = 1.2V$, $I_o=2A$

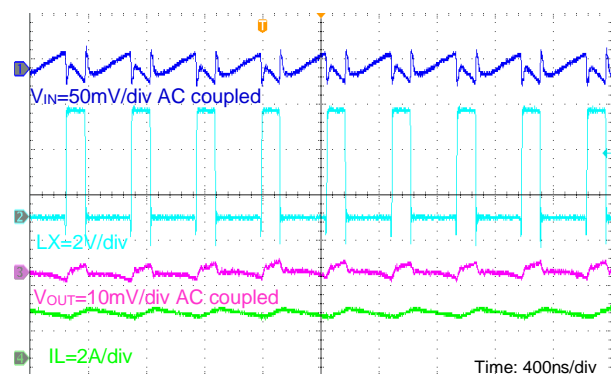

TYPICAL PERFORMANCE CHARACTERISTICS (continued)

Load Transient

$V_{IN} = 5V$, $V_{OUT} = 1.2V$, $I_o = 0A$ to $2A$

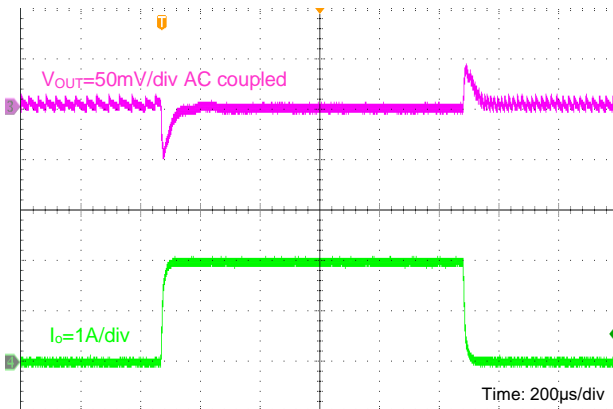

Load Transient

$V_{IN} = 5V$, $V_{OUT} = 1.2V$, $I_o = 0.2A$ to $1.8A$

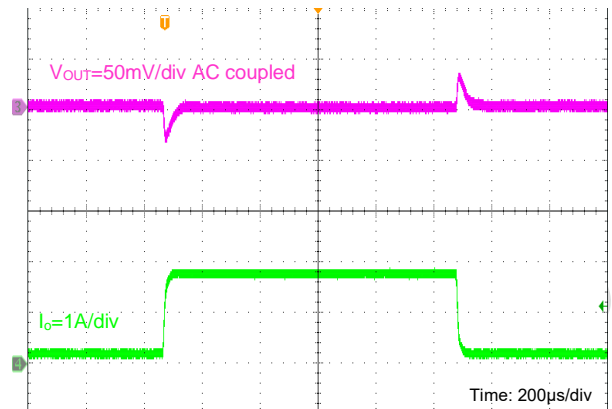

Load Transient

$V_{IN} = 5V$, $V_{OUT} = 1.2V$, $I_o = 0A$ to $1A$

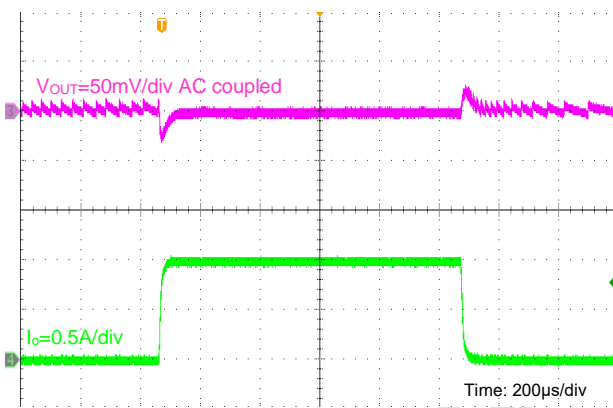

Load Transient

$V_{IN} = 5V$, $V_{OUT} = 1.2V$, $I_o = 1A$ to $2A$

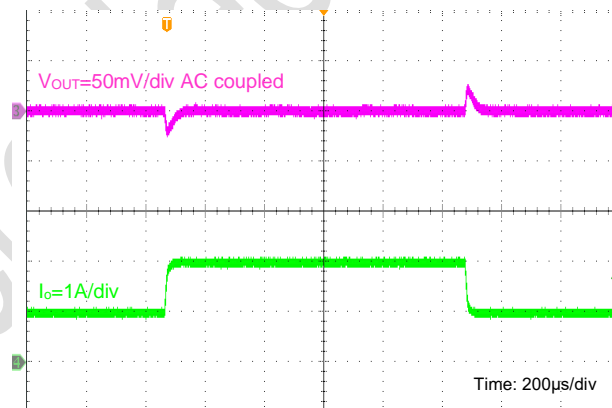

Output Short Entry

$V_{IN} = 5V$, $V_{OUT} = 1.2V$, $I_o = \text{No Load}$

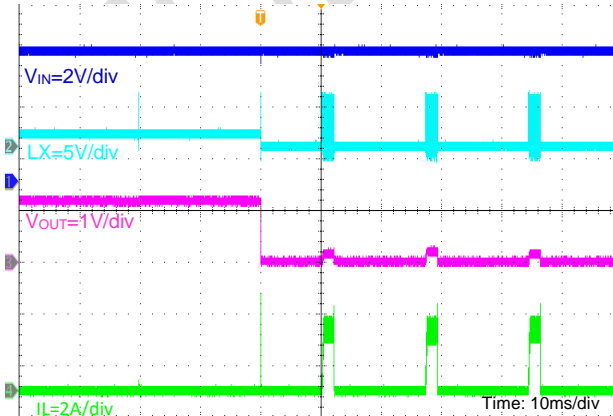

Output Short Recovery

$V_{IN} = 5V$, $V_{OUT} = 1.2V$, $I_o = \text{No Load}$

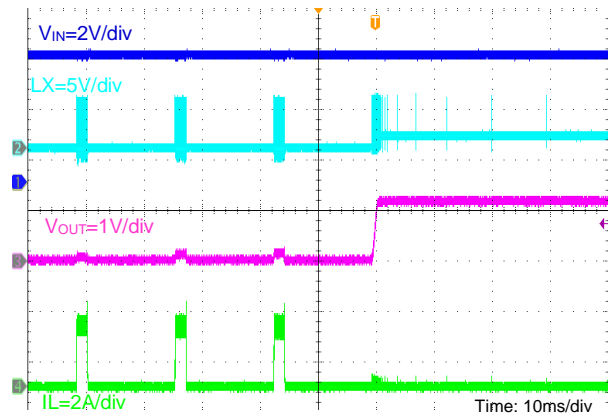

TYPICAL PERFORMANCE CHARACTERISTICS (continued)

Output Short Entry

$V_{IN} = 5V, V_{OUT} = 1.2V, I_o = 2A$

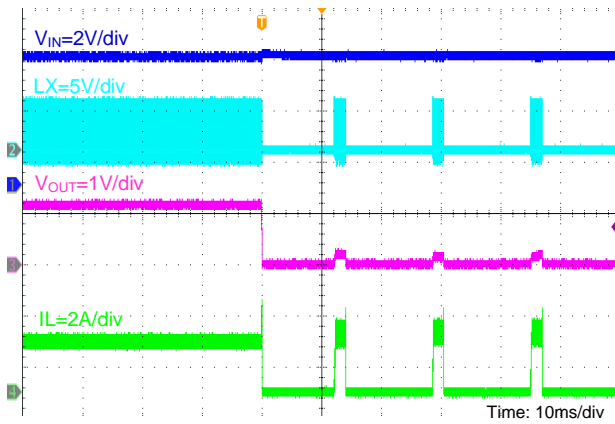

Output Short Recovery

$V_{IN} = 5V, V_{OUT} = 1.2V, I_o = 2A$

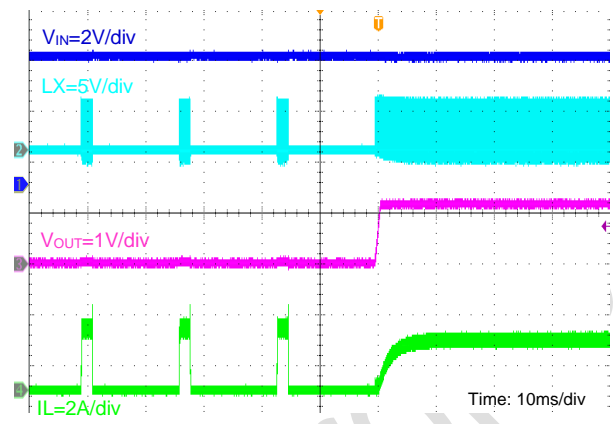

EN Enable Power On

$V_{IN} = 5V, V_{OUT} = 1.2V, \text{No Load}$

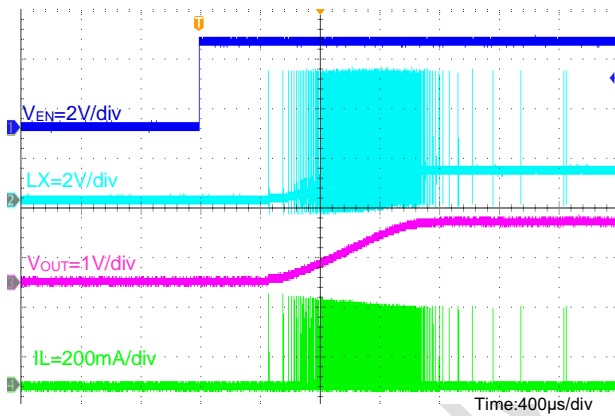

EN Disable Power down

$V_{IN} = 5V, V_{OUT} = 1.2V, \text{No Load}$

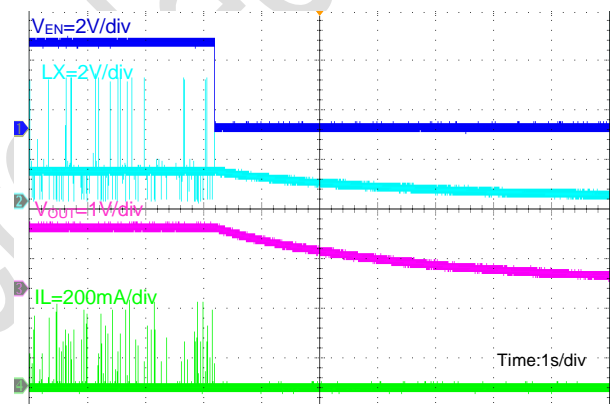

EN Enable Power On

$V_{IN} = 5V, V_{OUT} = 1.2V, I_o = 2A$

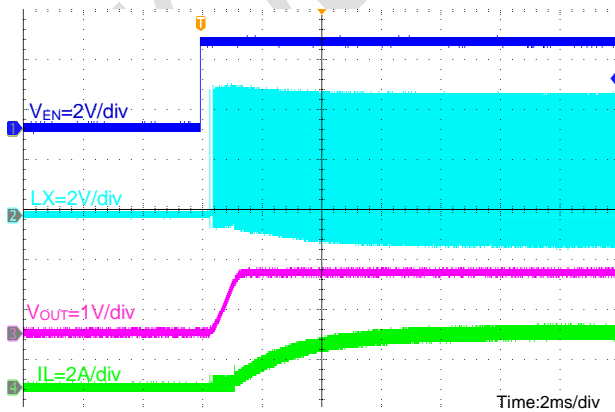

EN Disable Power down

$V_{IN} = 5V, V_{OUT} = 1.2V, I_o = 2A$

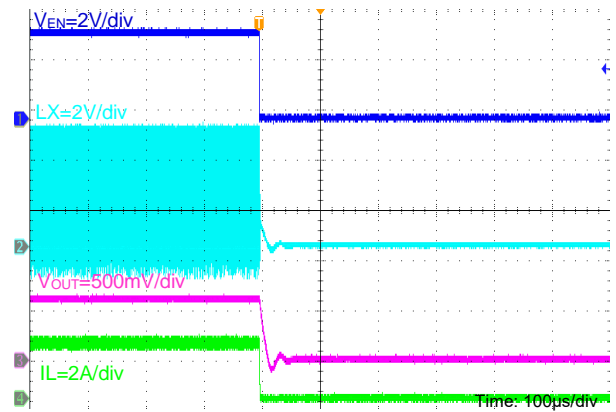

TYPICAL PERFORMANCE CHARACTERISTICS (continued)

Input Power On

$V_{IN} = 5V$, $V_{OUT} = 1.2V$, No Load

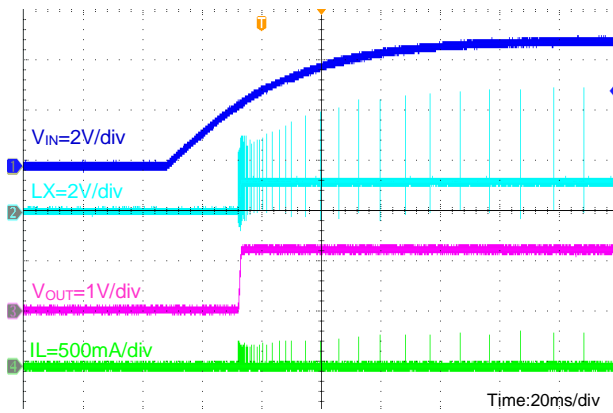

Input Power Down

$V_{IN} = 5V$, $V_{OUT} = 1.2V$, No Load

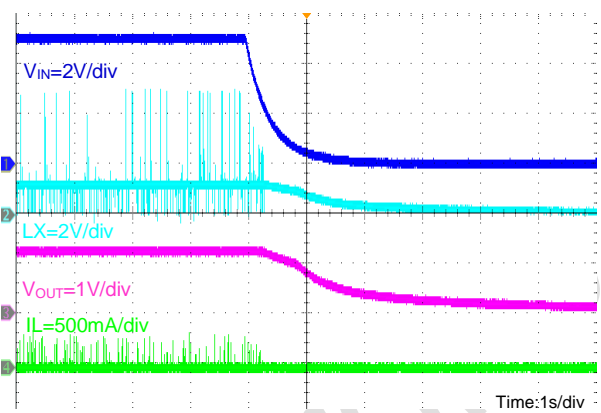

Input Power On

$V_{IN} = 5V$, $V_{OUT} = 1.2V$, $I_o = 2A$

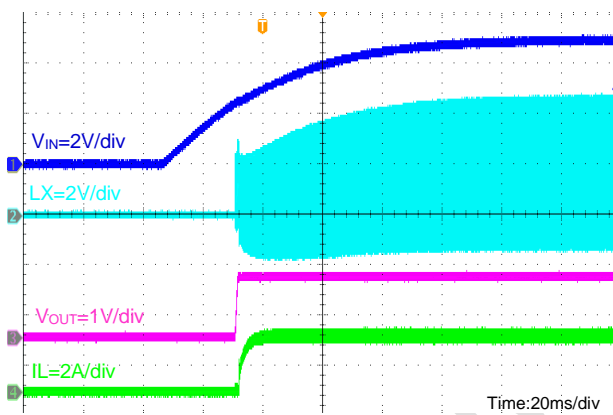

Input Power Down

$V_{IN} = 5V$, $V_{OUT} = 1.2V$, $I_o = 2A$

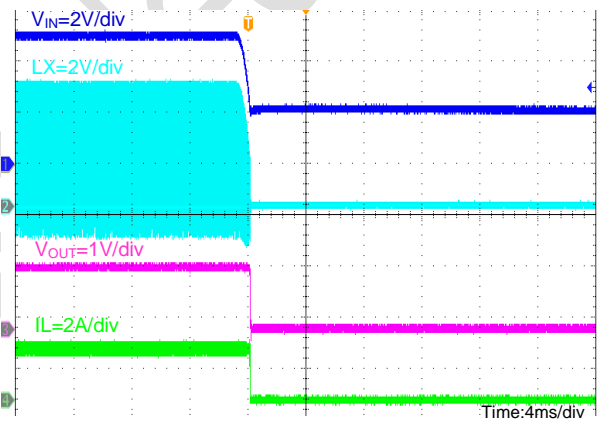

APPLICATION INFORMATION

Setting the Output Voltage

Figure 1 shows the basic application circuit for the TMI31602H. The TMI31602H can be externally programmed. Resistors R1 and R2 in Figure 1 program the output to regulate at a voltage higher than 0.600V. The external resistor sets the output voltage according to the following equation:

$$V_{OUT} = 0.6 \times \left(1 + \frac{R_1}{R_2}\right)$$

$$R_1 = (V_{OUT} / 0.6 - 1) \times R_2$$

Inductor Selection

For most designs, 1.0μH inductance can satisfy most application conditions. Inductance value is related to inductor ripple current value, input voltage, output voltage setting and switching frequency. The inductor value can be derived from the following equation:

$$L = \frac{V_{OUT} \times (V_{IN} - V_{OUT})}{V_{IN} \times \Delta I_L \times f_{OSC}}$$

Where ΔI_L is inductor ripple current. Large value inductors result in lower ripple current and small value inductors result in high ripple current, so inductor value has effect on output voltage ripple value. DC resistance of inductor which has impact on efficiency of DC/DC converter should be taken into account when selecting the inductor.

Input Capacitor Selection

The input capacitor reduces the surge current drawn from the input and switching noise from the device.

The input capacitor impedance at the switching frequency should be less than input source impedance to prevent high frequency switching current passing to the input.

A low ESR input capacitor sized for maximum RMS current must be used. Ceramic capacitors with X5R or X7R dielectrics are highly recommended because of their low ESR and small temperature coefficients.

A 10μF ceramic capacitor for most applications is sufficient. A large value may be used for improved input voltage filtering. Input capacitor must be closed to IN and GND pin of the device.

Output Capacitor Selection

The output capacitor is required to keep the output voltage ripple small and to ensure regulation loop stability. The output capacitor must have low impedance at the switching frequency. Ceramic capacitors with X5R or X7R dielectrics are recommended due to their low ESR and high ripple current ratings. The output ripple ΔV_{OUT} is determined by:

$$\Delta V_{OUT} \leq \frac{V_{OUT} \times (V_{IN} - V_{OUT})}{V_{IN} \times f_{OSC} \times L} \times \left(ESR + \frac{1}{8 \times f_{osc} \times C3} \right)$$

A 22 μ F ceramic can satisfy most applications. DC voltage derating of ceramic capacitor must be considered in applications, especially for 5V and 3.3V output voltage.

Layout Consideration

When laying out the printed circuit board, the following checking should be used to ensure proper operation of the TMI31602H. Check the following in your layout:

1. The power traces, consisting of the GND trace, the LX trace and the IN trace should be kept short, direct and wide.
2. Does the (+) plates of Cin connect to Vin as closely as possible. This capacitor provides the AC current to the internal power MOSFETs.
3. Keep the switching node, LX, away from the sensitive VOUT node.
4. Keep the (-) plates of Cin and Cout as close as possible

PACKAGE INFORMATION

DFN1.6x1.6-6

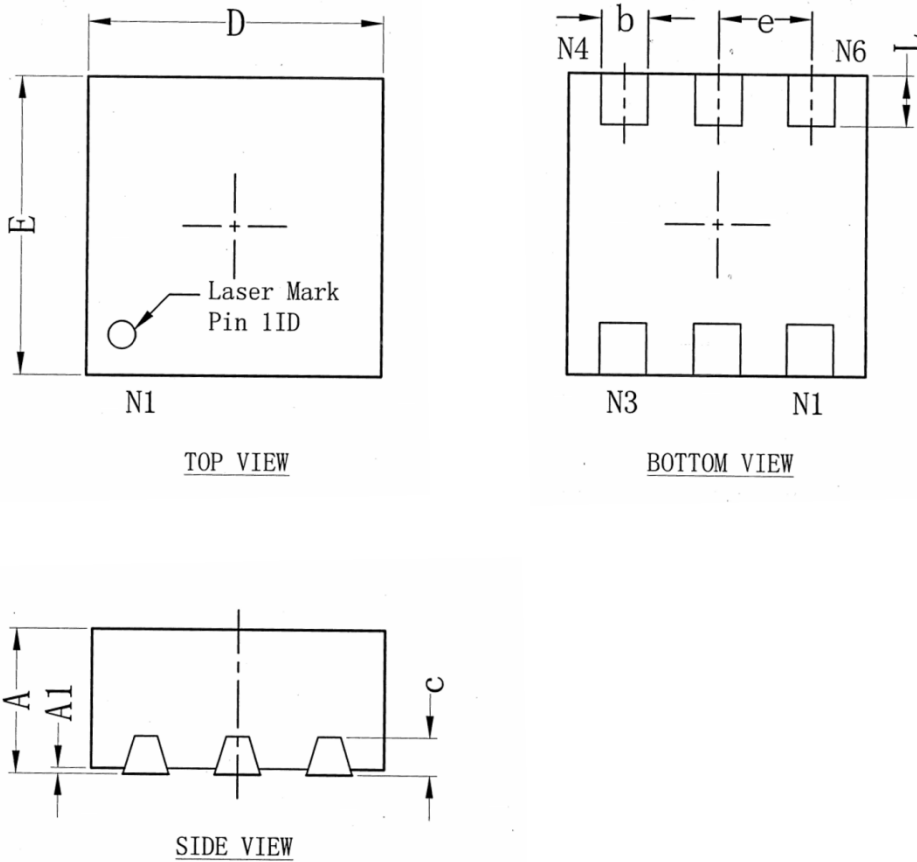

Unit: mm

Symbol	Dimensions In Millimeters			Symbol	Dimensions In Millimeters		
	Min	Typ	Max		Min	Typ	Max
A	0.70	0.75	0.80	D	1.5	1.6	1.65
A1	0.00	0.03	0.05	e	0.50 TYP		
b	0.20	0.25	0.30	E	1.5	1.6	1.65
c	0.203 REF			L	0.23	0.275	0.33

Note:

- 1) All dimensions are in millimeters.
- 2) Package length does not include mold flash, protrusion or gate burr.
- 3) Package width does not include inter lead flash or protrusion.
- 4) Lead popularity (bottom of leads after forming) shall be 0.10 millimeters max.
- 5) Pin 1 is lower left pin when reading top mark from left to right.

TAPE AND REEL INFORMATION

TAPE DIMENSIONS:

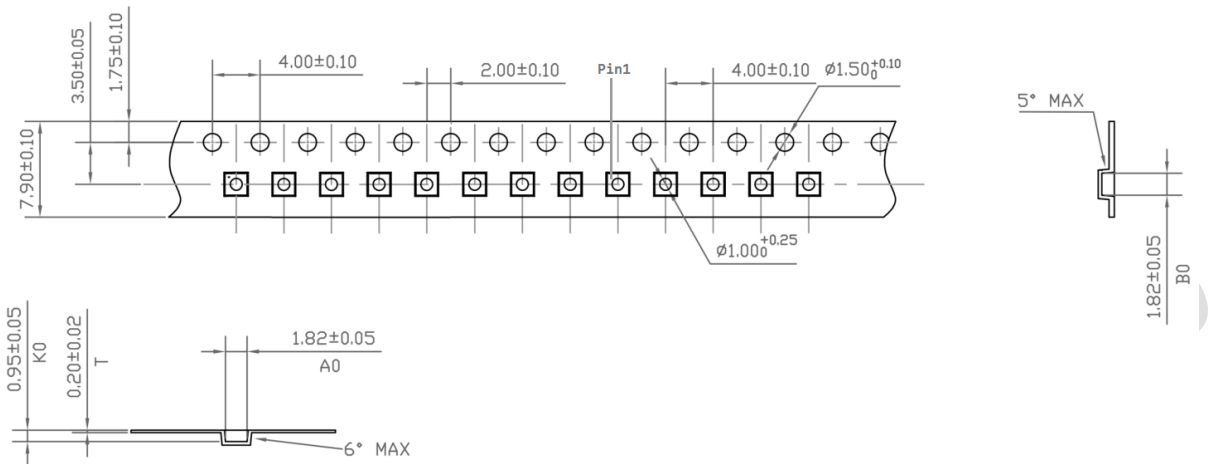

REEL DIMS

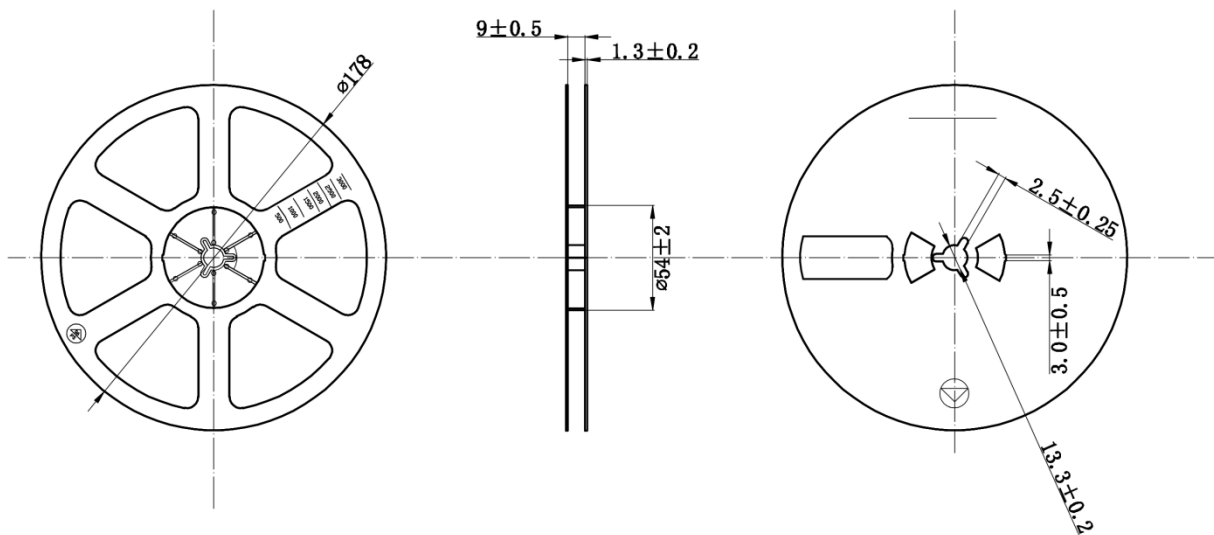

Note:

- 1) All Dimensions are in Millimeter
- 2) Quantity of Units per Reel is 3000
- 3) MSL level is level 3.