

SOT-23

$V_{(BR)DSS}$	$R_{DS(on)MAX}$	I_D
100V	5.0Ω@10V	200mA
	5.5Ω@4.5V	

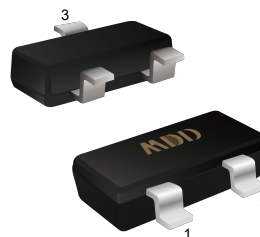

1. Gate
2. Source
3. Drain

Features

- Trench Power MV MOSFET technology
- Voltage controlled small signal switch
- Low input Capacitance
- Fast Switching Speed
- Low Input / Output Leakage

Application

- Small servo motor control
- Power MOSFET gate drivers
- Switching application

Marking

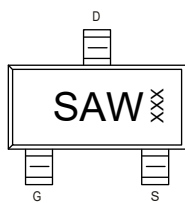

XXX:Date Code

Equivalent Circuit

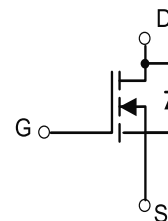

Absolute Maximum Ratings ($T_A=25^{\circ}C$ unless otherwise noted)

Parameter	Symbol	Value	Unit
Drain-Source Voltage	V_{DS}	100	V
Gate-Source Voltage	V_{GS}	±20	V
Continuous Drain Current	I_D	200	mA
Pulsed Drain Current (Note 1)	I_{DM}	800	mA
Power Dissipation(Note 2)	P_D	350	mW
Thermal Resistance from Junction to Ambient(Note 2)	$R_{\theta JA}$	357	$^{\circ}C/W$
Junction Temperature and Storage Temperature	T_J, T_{stg}	-50 ~150	$^{\circ}C$

Notes: Stresses exceeding Maximum Ratings may damage the device. Maximum Ratings are stress ratings only. Functional operation above the Recommended Operating Conditions is not implied. Extended exposure to stresses above the Recommended Operating Conditions may affect device reliability.

Ta = 25°C unless otherwise specified

Symbol	Parameter	Condition	Min	Typ	Max	Unit
$V_{(BR)DSS}$	Drain-Source Breakdown Voltage	$V_{GS}=0V, I_D=250\mu A$	100	--	--	V
I_{DSS}	Drain-Source Leakage Current	$V_{DS}=100V, V_{GS}=0V$	--	--	1	μA
I_{GSS}	Gate-Source Leakage Current	$V_{GS}=\pm 20V, V_{DS}=0V$	--	--	± 100	nA
$V_{GS(TH)}$	Gate Threshold Voltage	$V_{DS}=V_{GS}, I_D=250\mu A$	1.0	1.8	2.5	V
$R_{DS(ON)}$	Drain-Source On-State Resistance(Note 3)	$V_{GS}=10V, I_D=200mA$	--	3.0	5.0	Ω
		$V_{GS}=4.5V, I_D=175mA$	--	3.5	5.5	Ω

Dynamic Electrical Characteristics

Symbol	Parameter	Condition	Min	Typ	Max	Unit
C_{iss}	Input Capacitance	$V_{DS}=50V$ $V_{GS}=0V$ $f=1MHz$	--	32	--	pF
C_{oss}	Output Capacitance		--	10	--	pF
C_{rss}	Reverse Transfer Capacitance		--	7	--	pF
Q_g	Total Gate Charge		$V_{GS}=10V, V_{DS}=50V, I_D=0.2A$	--	1.61	--

Switching Characteristics

Symbol	Parameter	Condition	Min	Typ	Max	Unit
$t_{d(on)}$	Turn on Delay Time	$V_{DS}=50V$ $V_{GS}=10V$ $I_D=200mA$ $R_G=6\Omega$	--	1.7	--	ns
t_r	Turn on Rise Time		--	9	--	ns
$t_{d(off)}$	Turn Off Delay Time		--	17	--	ns
t_f	Turn Off Fall Time		--	7	--	ns

Source Drain Diode Characteristics

Symbol	Parameter	Condition	Min	Typ	Max	Unit
I_{SD}	Source drain current(Body Diode)	$T_A=25^\circ C$	--	--	200	mA
V_{SD}	Drain-Source Diode Forward Voltage	$I_S=200mA, V_{GS}=0V$	--	--	1.2	V

- Notes:**
- 1.Pulse width limited by maximum allowable junction temperature
 - 2.The value of P_D & $R_{\theta JA}$ is measured with the device mounted on 1 in² FR-4 board with 2oz.Copper, double sided, in a still air environment with $T_a=25^\circ C$.
 - 3.Pulse test ; Pulse width $\leq 300\mu s$, duty cycle $\leq 2\%$

■ Typical Performance Characteristics

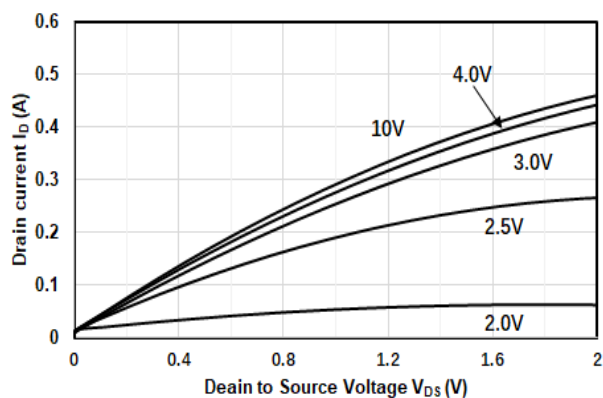

Figure1. Output Characteristics

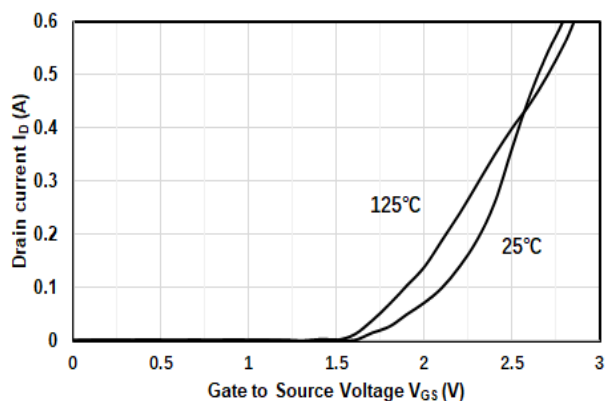

Figure2. Transfer Characteristics

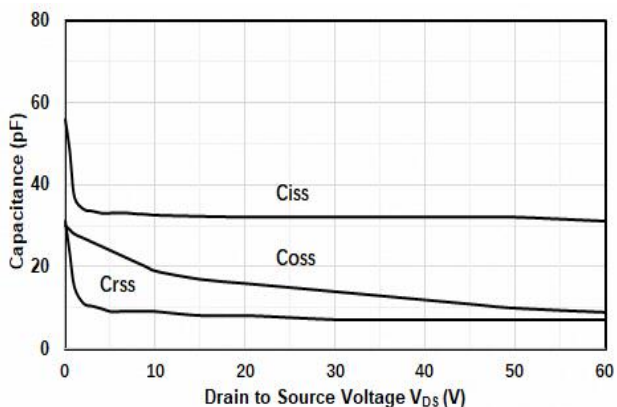

Figure3. Capacitance Characteristics

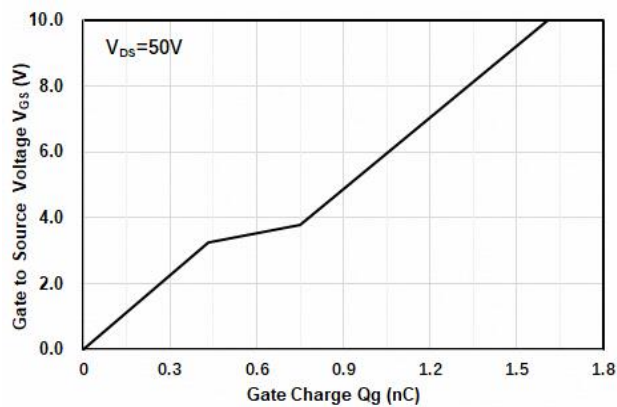

Figure4. Gate Charge

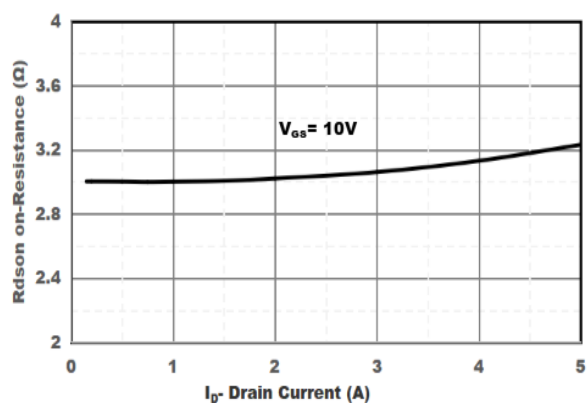

Figure5. Drain-Source on Resistance

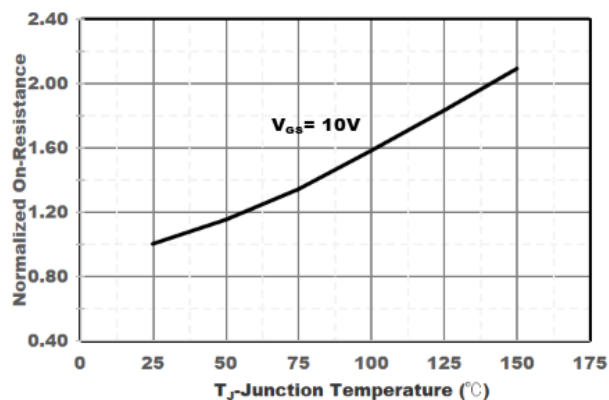

Figure6. Drain-Source on Resistance

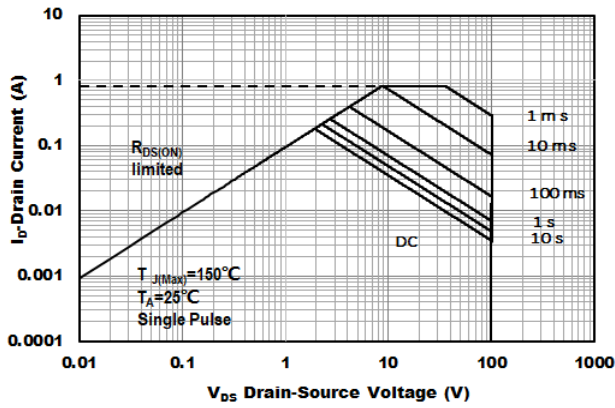

Figure7. Safe Operation Area

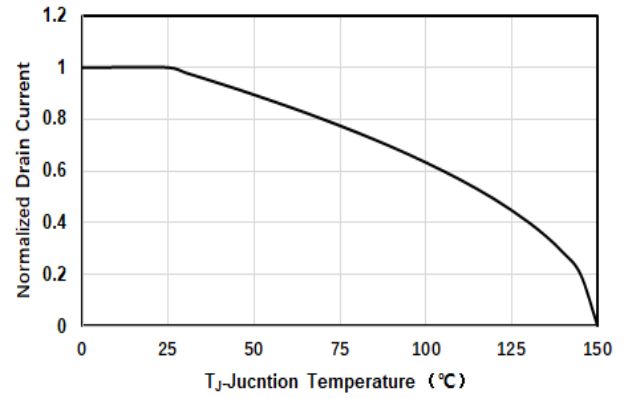

Figure8. Drain-Source Current

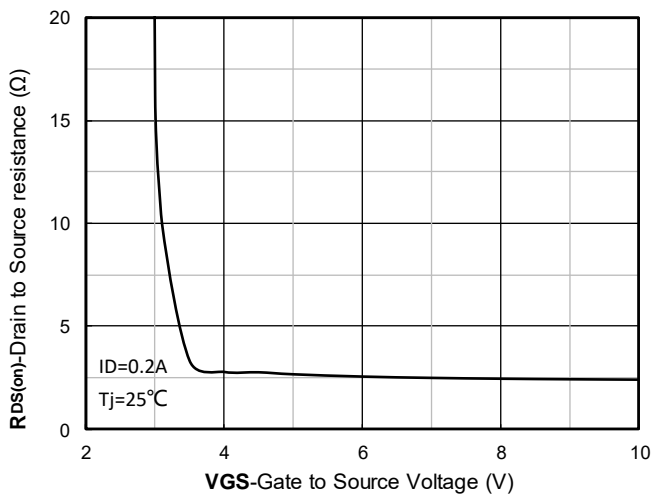

Figure 9. On-Resistance vs Gate to Source Voltage

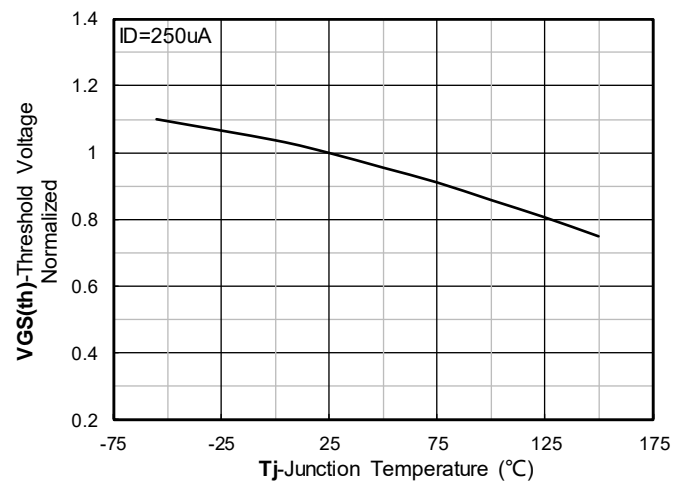
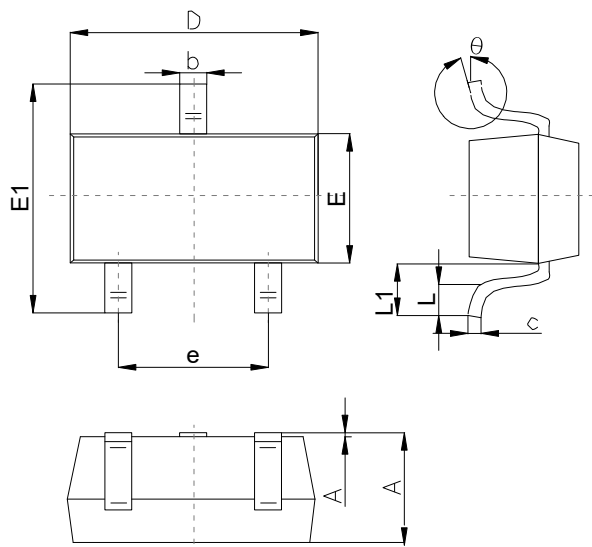

Figure 10. Normalized Threshold voltage

Outline Drawing

SOT-23 Package Outline Dimensions



Symbol	Dimensions In Millimeters		
	Min	Typ	Max
A	0.90		1.40
A1	0.00		0.10
b	0.30		0.50
c	0.08		0.20
D	2.80	2.90	3.10
E	1.20		1.60
E1	2.25		2.80
e	1.80	1.90	2.00
L	0.10		0.50
L1	0.4		0.55
θ	0°		10°

Suggested Pad Layout

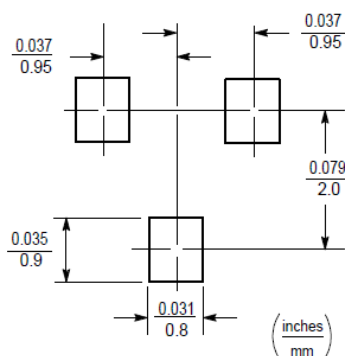

Note:

1. Controlling dimension: in/millimeters.
2. General tolerance: $\pm 0.05\text{mm}$.
3. The pad layout is for reference purposes only.