

## ZENER DIODES

### Features

- ◆ For surface mounted applications in order to optimize board space
- ◆ Low profile package
- ◆ Built-in strain relief
- ◆ Glass passivated junction
- ◆ Low inductance
- ◆ Typical  $I_R$  less than  $5.0\mu A$  above 11V
- ◆ High temperature soldering guaranteed:  
260°C / 10 seconds at terminals
- ◆ Plastic package has Underwriters Laboratory Flammability Classification 94V-0

**DO-214AC/SMA**

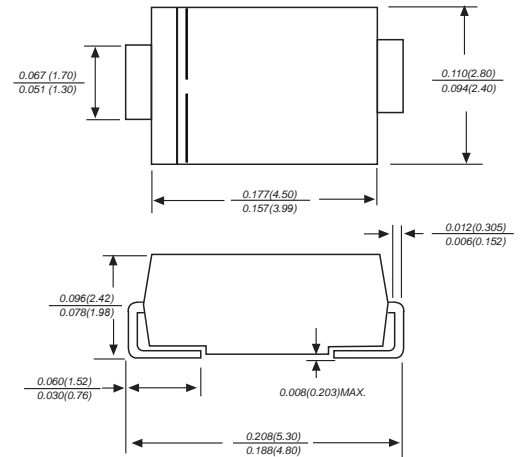

Dimensions in inches and (millimeters)

### Mechanical Data

**Case :** JEDEC DO-214AC/SMA Molded plastic body

**Terminals :** Solder plated, solderable per MIL-STD-750, Method 2026

**Polarity :** Polarity symbol marking on body

**Mounting Position :** Any

**Weight :** 0.0019ounce, 0.055grams

**Standard packing :** 12mm tape(E1A-481)

### Maximum Ratings And Electrical Characteristics

Ratings at 25°C ambient temperature unless otherwise specified.			
MDD Catalog Number	SYMBOLS	VALUE	UNITS
Peak Power Dissipation at $T_A=50^\circ C$ , Derate above 50°C (Note 1)	$P_D$	1.0 6.67	Watts mW/°C
Peak Forward Surge Current, 8.3 ms Single Half Sine-wave Superimposed on Rated Load (JEDEC method) (Note 2)	$I_{FSM}$	10.0	A
Forward Voltage	$V_F$	1.2	V
Operating and Storage Temperature Range	$T_J, T_{STG}$	-55 to + 150	°C

Notes: 1. Mounted on  $5.0mm^2$  (0.013mm thick) land areas.

2. Measured on 8.3ms Single Half Sine-wave or Equivalent Square Wave,  
Duty Cycle=4 Pulses Per Minute Maximum.



# 1SMA4728A THRU 1SMA4777A

Zener Voltage - 3.3 to 330 Volts Peak Pulse Power - 1.0 W

## Ratings And Characteristic Curves

Type	Marking	Zener Voltage Range <sup>(1)</sup>			I <sub>ZT</sub> (mA)	Dynamic Impedance	Reverse Current		Admissible Zener Current I <sub>ZM</sub> (mA)
		V <sub>ZT</sub> ( at I <sub>ZT</sub> )				Z <sub>ZT</sub> ( at I <sub>ZT</sub> )	I <sub>R</sub>	at V <sub>R</sub>	
		Min ( V )	Nom ( V )	Max ( V )		Max (Ω)	Max ( μA )	( V )	
1SMA4728A	728A	3.10	3.3	3.50	75	10	100	1	285
1SMA4729A	729A	3.40	3.6	3.80	69	10	100	1	263
1SMA4730A	730A	3.70	3.9	4.10	64	9.0	50	1	243
1SMA4731A	731A	4.06	4.3	4.56	58	9.0	25	1	219
1SMA4732A	732A	4.50	4.7	4.93	53	8.0	10	1	203
1SMA4733A	733A	4.84	5.1	5.36	49	7.0	10	1	186
1SMA4734A	734A	5.32	5.6	5.92	45	5.0	10	2	170
1SMA4735A	735A	5.86	6.2	6.51	41	2.0	10	3	154
1SMA4736A	736A	6.46	6.8	7.18	37	3.5	10	4	140
1SMA4737A	737A	7.12	7.5	7.88	34	4.0	10	5	127
1SMA4738A	738A	7.79	8.2	8.67	31	4.5	10	6	116
1SMA4739A	739A	8.60	9.1	9.59	28	5.0	10	7	104
1SMA4740A	740A	9.50	10	10.5	25	7.0	10	7	95
1SMA4741A	741A	10.4	11	11.6	23	8.0	5	8	86
1SMA4742A	742A	11.4	12	12.6	21	9.0	5	9	79
1SMA4743A	743A	12.4	13	14.1	19	10	5	10	71
1SMA4744A	744A	13.8	15	15.8	17	14	5	11	63
1SMA4745A	745A	15.2	16	17.1	16	16	5	12	58
1SMA4746A	746A	16.8	18	19.2	14	20	5	13	52
1SMA4747A	747A	19.0	20	21.2	13	22	5	15	47
1SMA4748A	748A	20.8	22	23.3	12	23	5	17	43
1SMA4749A	749A	22.8	24	26.0	11	25	5	18	38
1SMA4750A	750A	25.3	27	28.9	9.5	35	5	21	35
1SMA4751A	751A	28.2	30	32.0	8.5	40	5	23	31
1SMA4752A	752A	31.3	33	34.9	7.5	45	5	25	28
1SMA4753A	753A	34.2	36	37.9	7.0	50	5	27	26
1SMA4754A	754A	37.2	39	41.5	6.5	60	5	30	24
1SMA4755A	755A	40.9	43	45.6	6.0	70	1	32	22
1SMA4756A	756A	44.9	47	49.8	5.5	80	1	35	20
1SMA4757A	757A	48.6	51	54.0	5.0	95	1	38	18
1SMA4758A	758A	53.6	56	58.8	4.5	110	1	42	17
1SMA4759A	759A	58.9	62	65.6	4.0	125	1	47	15
1SMA4760A	760A	64.6	68	71.7	3.7	150	1	52	14
1SMA4761A	761A	71.2	75	78.8	3.3	175	1	56	12
1SMA4762A	762A	77.9	82	87.0	3.0	200	1	62	11
1SMA4763A	763A	86.0	91	96.0	2.8	250	1	69	10
1SMA4764A	764A	95.0	100	105	2.5	350	1	76	9.5
1SMA4765A	765A	104	110	116	2.3	450	1	84	8.6
1SMA4766A	766A	114	120	127	2.0	550	1	91	7.8
1SMA4767A	767A	125	135	142	1.9	700	1	100	7.0
1SMA4768A	768A	140	150	157	1.7	900	1	110	6.3
1SMA4769A	769A	155	165	172	1.6	1100	1	120	5.8
1SMA4770A	770A	170	180	191	1.4	1200	1	135	5.2
1SMA4771A	771A	189	200	211	1.2	1400	1	150	4.7
1SMA4772A	772A	209	220	231	1.0	1600	1	165	4.3
1SMA4773A	773A	229	240	251	1.0	1800	1	180	3.9
1SMA4774A	774A	249	260	271	1.0	2000	1	190	3.7
1SMA4775A	775A	269	280	291	1.0	2100	1	205	3.4
1SMA4776A	776A	289	300	315	1.0	2300	1	230	3.1
1SMA4777A	777A	313	330	346	1.0	2500	1	250	2.8

( 1 ) V<sub>ZT</sub> is tested with pulses (20 ms)

FIG.1- POWER TEMPERATURE DERATING CURVE

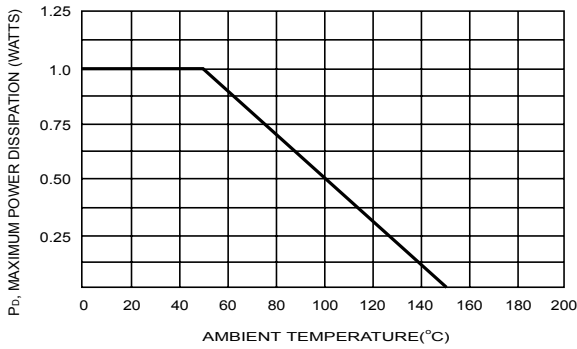

FIG.2- TYPICAL FORWARD CHARACTERISTICS

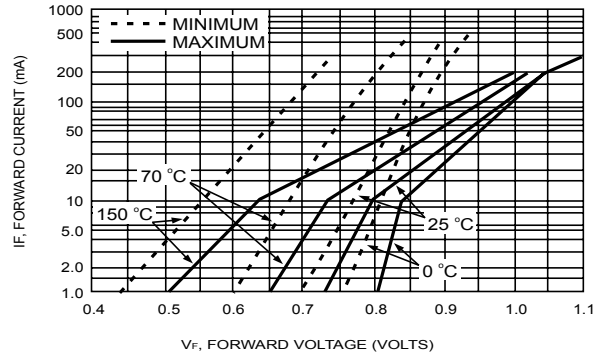

FIG.3- EFFECT OF ZENER CURRENT ON ZENER IMPEDANCE

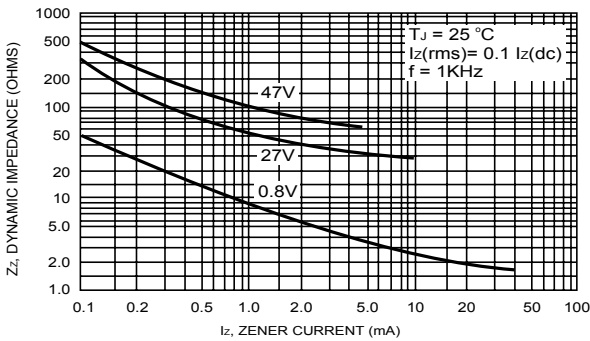

FIG.5- TYPICAL LEAKAGE CURRENT

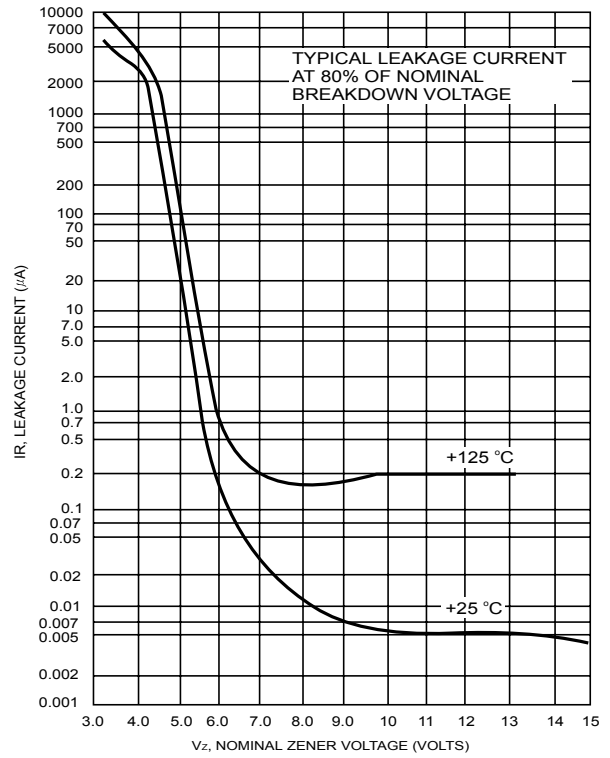

FIG.4- EFFECT OF ZENER VOLTAGE ON ZENER IMPEDANCE

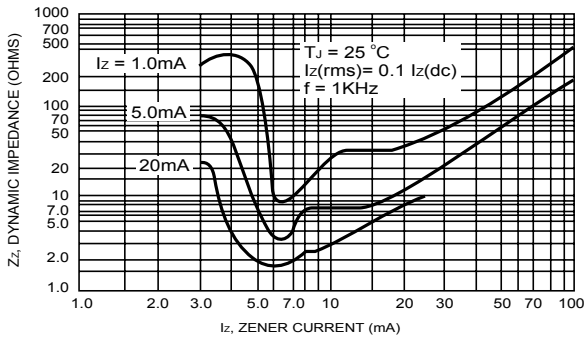

FIG.6- TYPICAL CAPACITANCE versus V<sub>Z</sub>

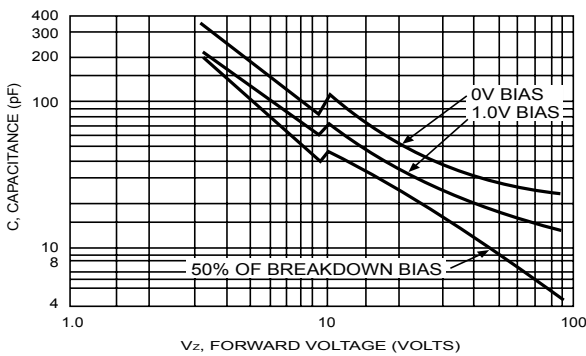
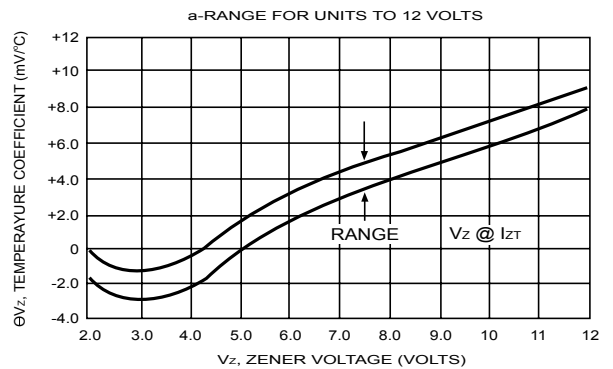

FIG.7- TEMPERATURE COEFFICIENTS



The cruve graph is for reference only

FIG.7- TEMPERATURE COEFFICIENTS

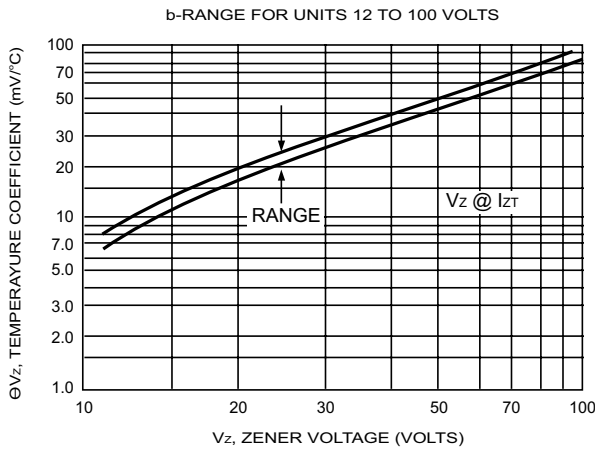

FIG.8- EFFECT OF ZENER CURRENT

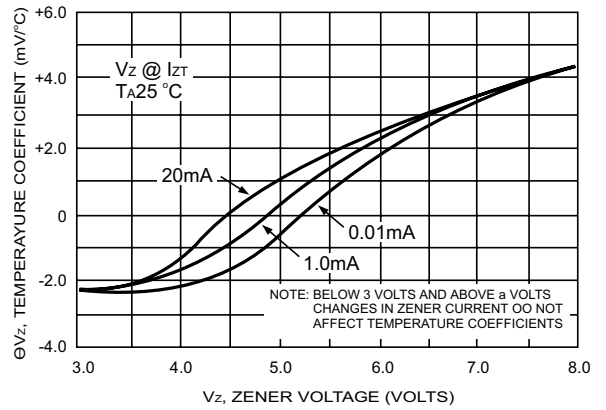
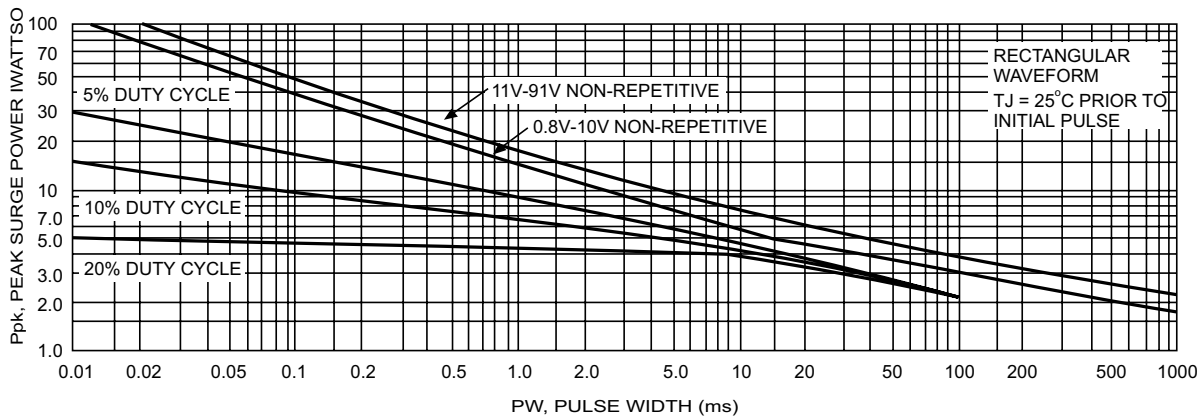
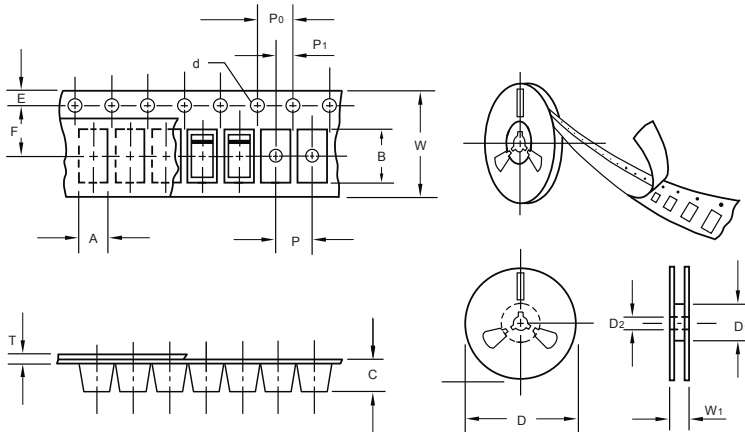

FIG.9- MAXIMUM SURGE POWER



The cruve graph is for reference only

## Packing information



unit:mm

Item	Symbol	Tolerance	SMA
Carrier width	A	0.1	2.80
Carrier length	B	0.1	5.33
Carrier depth	C	0.1	2.36
Sprocket hole	d	0.05	1.50
13" Reel outside diameter	D	2.0	330.00
13" Reel inner diameter	D <sub>1</sub>	min	50.00
7" Reel outside diameter	D	2.0	178.00
7" Reel inner diameter	D <sub>1</sub>	min	62.00
Feed hole diameter	D <sub>2</sub>	0.5	13.00
Sprocket hole position	E	0.1	1.75
Punch hole position	F	0.1	5.50
Punch hole pitch	P	0.1	4.00
Sprocket hole pitch	P <sub>0</sub>	0.1	4.00
Embossment center	P <sub>1</sub>	0.1	2.00
Overall tape thickness	T	0.1	0.28
Tape width	W	0.3	12.00
Reel width	W <sub>1</sub>	1.0	18.00

Note: Devices are packed in accordance with EIA standard RS-481-A and specifications listed above.

## Reel packing

PACKAGE	REEL SIZE	REEL (pcs)	COMPONENT SPACING (m/m)	BOX (pcs)	INNER BOX (m/m)	REEL DIA. (m/m)	CARTON SIZE (m/m)	CARTON (pcs)	APPROX. GROSS WEIGHT (kg)
SMA	7"	2,000	4.0	4,000	183*155*183	178	382*356*392	80,000	12.0
SMA	11"	5,000	4.0	10,000	290*290*38	330	310*310*360	80,000	11.0
SMA	13"	7,500	4.0	15,000	335*335*38	330	350*330*360	120,000	14.5

## Suggested Pad Layout

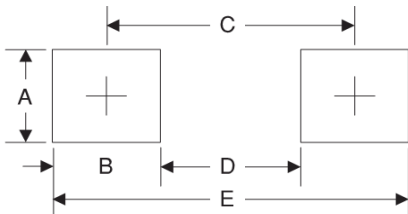

Symbol	Unit (mm)	Unit (inch)
A	1.68	0.066
B	1.52	0.060
C	3.93	0.154
D	2.41	0.095
E	5.45	0.215