

HRM Series

# MIL/IEC Standard SMA Connector



SMA



MIL Standard



Wide Variation



Jun.1.2024 Copyright 2024 HIROSE ELECTRIC CO., LTD. All Rights Reserved.



## Overview

This is MIL Standard SMA(SUB-MINIATURE TYPE A) Connector series. In 1967, it was developed by our company for the first time as a domestic product, and its reliability has been recognized ever since.

Applicable Standards

MIL-C-39012

IEC 60169-15

## Features

### 1. High Performance

With a design intended to compensate for discontinuous transmission line capacity, it has high frequency performance.

### 2. Small Size, Light Weight and Robust

The receptacle flanges are square in shape, measuring 12.7mm on each side. Their area being about one-half that of the BNC series and about one-fourth that of the S series, they are most suitable for high-density mounting. Moreover, their weights are greatly reduced (a standard receptacle weights only about 3 grams). Even though they are compact and lightweight, their durability is no lower than that of other types, because they use stainless-steel shells.

### 3. High Reliability

HRM Series has been used in a wide range of fields, including consumer electronics, defense, communications and aerospace industrial equipment, with a history of excellent reliability.

### 4. Variations

We have wide varieties such as the excellence impedance matching type HRM(G), the reverse-type SMA(R) with the male and female of the central contact inverted, and the item for small-diameter cables that can connect both ends to U.FL, MMCX Series.

We have various receptacle, terminators depending on application.

### 5. RoHS2 Compliant

## Applications

Cable or radio communication equipment, broadcasting equipment, radar equipment, for in-flight wiring in electronic measuring device, for connection between units and contact for input and output of equipment configuration.

## Product Specifications (Connectors)

Nominal Characteristic Impedance	50 Ω	Operating Temperature	-55 to +125°C
Rated Voltage	330V AC	Operating Relative Humidity	85% Max.
Frequency Range	0 to 18GHz		

(Note) Ratings and standards may vary by products.

Items	Specifications	Conditions
Contact Resistance	4m Ω Max.	Measured at 100mA Max.
Insulation Resistance	5000M Ω Min.	Measured at DC 500V
Withstanding Voltage	No insulation breakdown	1000V AC for 60 sec.
V.S.W.R.*	See below	See below
Female Contact Extraction Force	1.5N Min., 0.3N Min.	Measured with φ 0.910 pin gauge Measured with φ 0.9017 pin gauge
Center Contact Fixed Torque	16.7mN·m Min.	Measured with Applicable Connector
Coupling Tightening Torque	0.6 to 1.0Nm	Measured with Applicable Connector
Coupling Fixed Strength	490N Min.	Measured with Applicable Connector
Mating Durability	Contact Resistance : 6m Ω Max.	1000 times
Vibration Resistance	No electrical discontinuity of 1 μs or more No damage, cracks, or parts dislocation	Frequency : 10 to 2000Hz, Half amplitude : 0.75mm Acceleration : 196m/s <sup>2</sup> 4 hours in each of the 3 axis
Shock Resistance	No electrical discontinuity of 1 μs or more No damage, cracks, or parts dislocation	Acceleration : 1960m/s <sup>2</sup> , Duration : 6ms, Wave form : Half-sine wave, 3 times in each of the 3 axis
Humidity	Insulation Resistance : 100M Ω Min. (in a high humidity environment) Insulation resistance : 1000M Ω Min. (in a dry environment)	Left for 10 cycles (240 hours) in an environment with the temperature ranging from +25 to 65°C and the humidity ranging from 90 to 98%.
Heat Shock Resistance	No damage, cracks, or parts dislocation	( - 65°C : 30 min. → 5 to 35°C : within 5 min. → 125 ± 2°C : 30 min. → 5 to 35°C : within 5 min.) 5 cycles
Corrosion Resistance	Satisfying the V.S.W.R Standard	Continuous 48 hour cycle in 5% salt water solution

\*V.S.W.R. (Voltage Standing Wave Ratio) Measurement System

V.S.W.R. of HRM series is as shown below.

The above V.S.W.R. specification values were measured using the measurement system shown below.

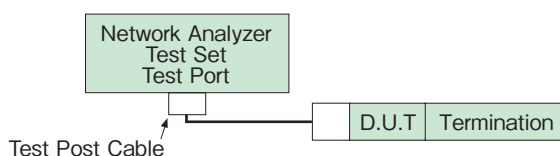

(Note1) The cable connector is measured with the connector attached to the applicable cable.

(Note2) Receptacle and plug receptacle are measured with the measuring adapter installed.

## Materials / Finish

### Connector

Component	Material	Finish		
		Type	Plating	
Shell	Stainless steel	Gold Plating Type		
		S Type	Straight Type	Passivated Finish
			Right Angle Type	Nickel Plating
Coupling	Stainless steel	Gold Plating Type		
		S Type		Passivated Finish
Female Contact	Beryllium steel	–	Gold Plating	
Male Contact	Brass	–	Gold Plating	
Crimp Sleeve	Copper	–	Nickel Plating	
Insulator	PTFE	–	–	
Rubber Gasket	Silicone rubber	–	–	
Boot	Polyolefin	–	–	

(Note) There may be products which differ from the above tables.

## Product Number Structure

Refer to the chart below when determining the product specifications from the product number.

**HRM** - [ ] - [ ]

①      ②      ③

① Series Name	HRM, HRM(G) [Excellence Impedance Matching Type] SMA(R) [Reverse Type]	③ Serial Number	
② Connector Type	100 to 199 : Semi-Rigid Cable Connector 200 to 299 : Flexible Cable or Semi-Flexible Cable Connector 300 to 399 : Receptacle 400 to 499 : Plug Receptacle 500 to 599 : Adapter, Conversion Adapter (Some product name structure differ.) Short Connector, Cap		

### Classification by Surface Treatment

Products having the same structure, shape and dimensions may have different surface treatments of their armor (shell). There are gold-plated products (gold-plated type) and passivated products (S type). Those of the S type have the letter S is added to the end of their part number. (For passivated treatment, see S-Type recommendations page.)

Ex.1 HRM-301(09) : Exterior, Gold Plating      Ex.2 HRM-301S : Exterior, Passivated

# Functional Diagram

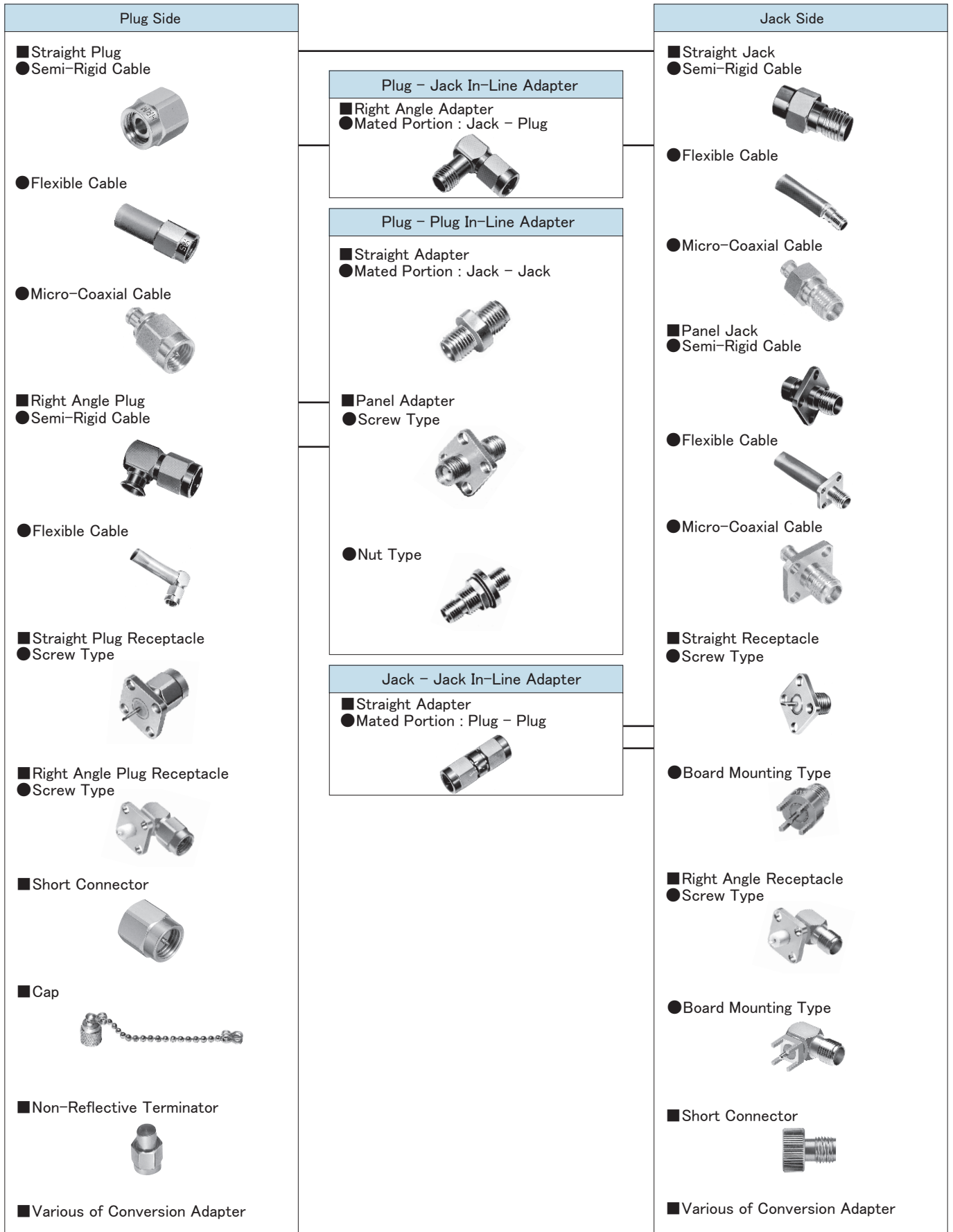

Jun.1.2024 Copyright 2024 HIROSE ELECTRIC CO., LTD. All Rights Reserved.

## Straight Plug

### ● For 0.141 inch Semi-Rigid Cable

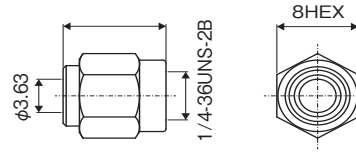

Part No.	HRS No.	Finish	Purchase Unit
HRM-101(09)	CL0323-0001-1-09	Gold Plating	20pcs per bag
HRM-101S(09)	CL0323-0153-0-09	Shell : Gold Plating Coupling : Passivated	

### ● For 0.085 inch Semi-Rigid Cable

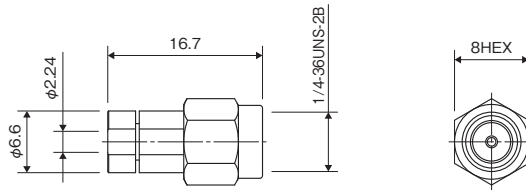

Part No.	HRS No.	Finish	Purchase Unit
HRM-100-1S(40)	CL0323-0125-4-40	Shell and Coupling : Passivated Tightner : Gold Plating	20pcs per bag

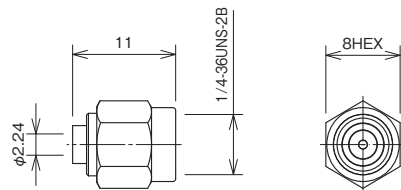

Part No.	HRS No.	Finish	Purchase Unit
HRM-100-2.19PSP(40)	CL0323-0528-0-40	Shell : Gold Plating Coupling : Passivated	20pcs per bag

●For 1.6mm Semi-Rigid Cable

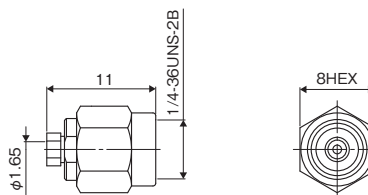

Part No.	HRS No.	Finish	Purchase Unit
HRM-100-18B(40)	CL0323-0442-7-40	Shell : Nickel Plating Coupling : Passivated Tightner : Gold Plating	20pcs per bag

●For 0.085 inch Semi-Flexible Cable

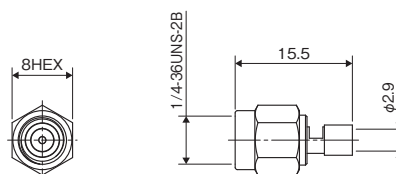

Part No.	HRS No.	Finish	Purchase Unit
HRM-200-SF085PSG	CL0323-0037-0-00	Shell : Gold Plating Coupling : Passivated	20pcs per bag

●For Flexible Cable

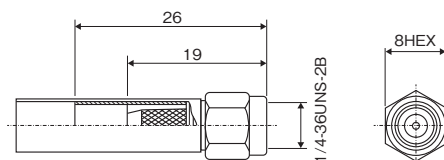

Part No.	HRS No.	Applicable Cable	Purchase Unit
HRM-202S(40)	CL0323-0117-6-40	RG-142B/U RG-55/U	20pcs per bag

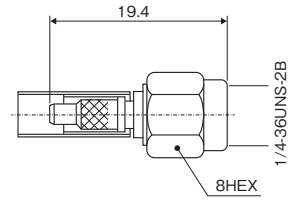

Part No.	HRS No.	Applicable Cable	Purchase Unit
HRM-200-2-C(40)	CL0323-0369-9-40	1.5D-2V	20pcs per bag
HRM-200-2S-C(40)	CL0323-0412-6-40		
HRM-200-2-1C(40)	CL0323-0520-9-40	1.5D-2W	
HRM-200-2S-1C(40)	CL0323-0500-1-40		

## Right Angle Plug

### ● For 0.141 inch Semi-Rigid Cable

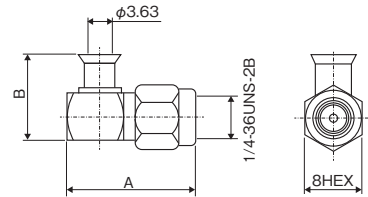

Part No.	HRS No.	Finish	A	B	Purchase Unit
HRM-104(40)	CL0323-0004-0-40	Gold Plating	17.9	11	20pcs per bag
HRM-104S(40)	CL0323-0122-6-40	Shell : Gold Plating Coupling : Passivated			



●For 0.085 inch Semi-Rigid Cable

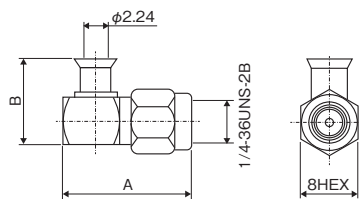

Part No.	HRS No.	Finish	A	B	Purchase Unit
HRM-100-4(40)	CL0323-0147-7-40	Gold Plating	17.9	11	20pcs per bag
HRM-100-4S-A(40)	CL0323-0695-2-40	Shell : Gold Plating Coupling : Passivated			
HRM-LP100-085BN-2(40)	CL0323-0841-2-40	Shell : Brass, Nickel Plating	17	9.6	

●For 0.085 inch Semi-Flexible Cable

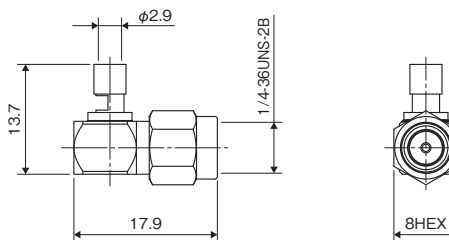

Part No.	HRS No.	Finish	Purchase Unit
HRM-200-SF085LPSG	CL0323-0039-0-00	Shell : Gold Plating Coupling : Passivated	20pcs per bag

●For Flexible Cable

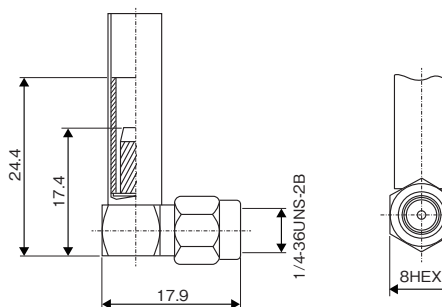

Part No.	HRS No.	Applicable Cable	Purchase Unit
HRM-208(40)	CL0323-0012-8-40	RG-142B/U RG-55/U	20pcs per bag
HRM-208S(40)	CL0323-0119-1-40		

Jun.1.2024 Copyright 2024 HIROSE ELECTRIC CO., LTD. All Rights Reserved.

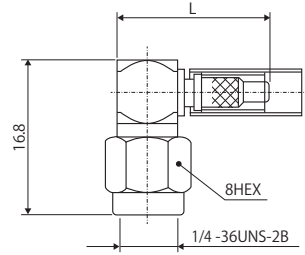

Part No.	HRS No.	Applicable Cable	L	Purchase Unit
HRM-200-4S-C(40)	CL0323-0413-9-40	1.5D-2V	16.8	20pcs per bag
HRM-200-1.5LPSN	CL0323-0891-0-00		16	
HRM-200-4S-1C(40)	CL0323-0505-5-40	1.5D-2W	16.8	
HRM-200-1.5WLPSN(40)	CL0323-0751-1-40		16	
HRM-208S-1.5DQS(40)	CL0323-0687-4-40	1.5D-HQ.SUPER	14.5	

## Jack

### ● For 0.141 inch Semi-Rigid Cable

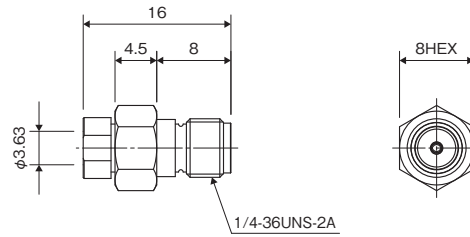

Part No.	HRS No.	Finish	Purchase Unit
HRM-102(09)	CL0323-0002-4-09	Gold Plating	20pcs per bag
HRM-102S(09)	CL0323-0131-7-09	Shell : Passivated Tightner : Gold Plating	

### ●For Flexible Cable

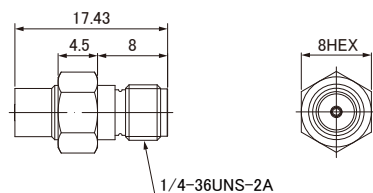
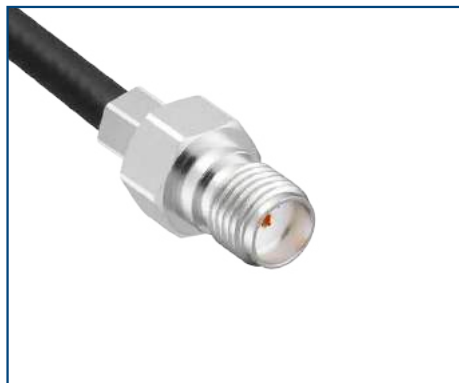

Part No.	HRS No.	Applicable Cable	Purchase Unit
HRM-200-1.5WJBN(40)	CL0323-0711-7-40	1.5D-2W	20pcs per bag
HRM-200-1.5JBN(40)	CL0323-0799-8-40	1.5D-2V	

## Panel Jack

### ●For 0.141 inch Semi-Rigid Cable

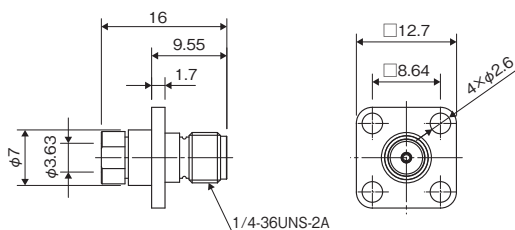

Part No.	HRS No.	Finish	Purchase Unit
HRM-103S(09)	CL0323-0141-0-09	Shell : Passivated Tightner : Gold Plating	20pcs per bag

### ●For 1.6mm Semi-Rigid Cable

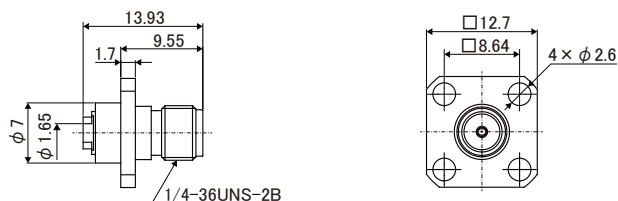
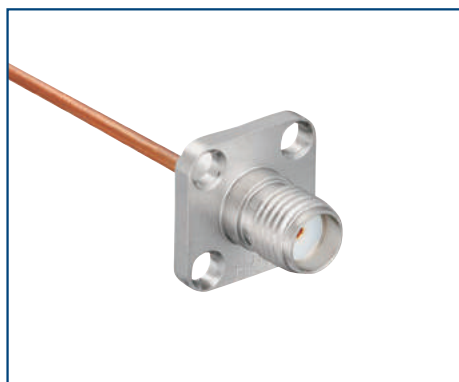

Part No.	HRS No.	Finish	Purchase Unit
HRM-100-32S(40)	CL0323-0251-9-40	Shell : Passivated Tightner : Gold Plating	20pcs per bag

## ● For Flexible Cable

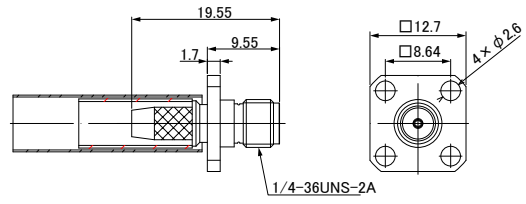
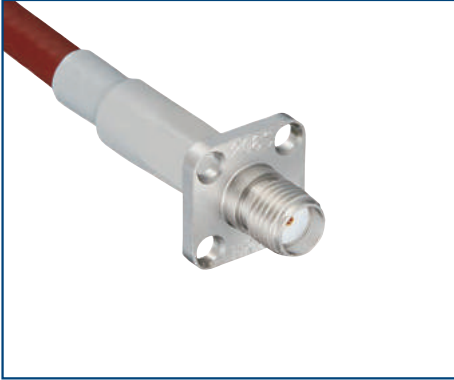

HRM-206S

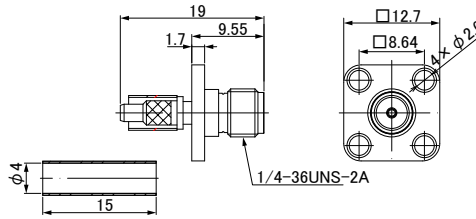

HRM-200-3S-1C

Part No.	HRS No.	Applicable Cable	Purchase Unit
HRM-206S	CL0323-0118-9-00	RG-142B/U, RG-55/U	20pcs per bag
HRM-200-3-C	CL0323-0370-8-00	1.5D-2V	
HRM-200-3S-1C	CL0323-0906-6-00	1.5D-2W	

## Micro-Coaxial Cable (Frequency up to 8 GHz)

### ● Straight Plug

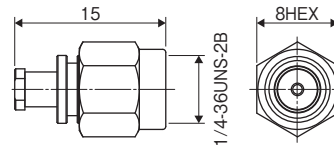

Part No.	HRS No.	Applicable Cable	Purchase Unit
HRM-200-040PBN(40)	CL0323-0790-3-40	$\phi$ 0.81	20pcs per bag
HRM-200-066PBN(40)	CL0323-0791-6-40	$\phi$ 1.13, $\phi$ 1.32	
HRM-200-088PBN(40)	CL0323-0800-5-40	$\phi$ 1.37, $\phi$ 1.48	

### ●Straight Jack

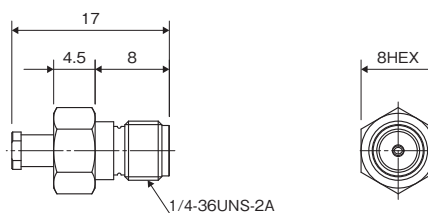

Part No.	HRS No.	Applicable Cable	Purchase Unit
HRM-200-040JBN(40)	CL0323-0792-9-40	φ 0.81	20pcs per bag
HRM-200-066JBN(40)	CL0323-0793-1-40	φ 1.13, φ 1.32	
HRM-200-088JBN(40)	CL0323-0801-8-40	φ 1.37, φ 1.48	

### ●Panel Jack (4 Screws Type)

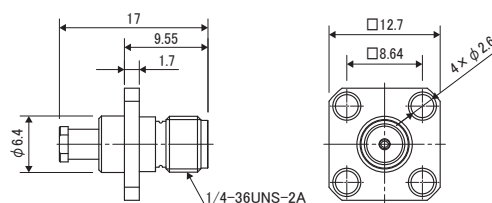

Part No.	HRS No.	Applicable Cable	Purchase Unit
HRM-200-040PJ4BN(40)	CL0323-0795-7-40	φ 0.81	20pcs per bag
HRM-200-066PJ4BN(40)	CL0323-0796-0-40	φ 1.13, φ 1.32	
HRM-200-088PJ4BN(40)	CL0323-0803-3-40	φ 1.37, φ 1.48	

### ●Panel Jack (2 Screws Type)

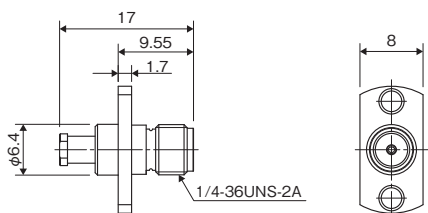

Part No.	HRS No.	Applicable Cable	Purchase Unit
HRM-200-040PJ2BN(40)	CL0323-0794-4-40	φ 0.81	20pcs per bag
HRM-200-066PJ2BN(40)	CL0323-0788-1-40	φ 1.13, φ 1.32	
HRM-200-088PJ2BN(40)	CL0323-0802-0-40	φ 1.37, φ 1.48	

### ● Panel Jack (Nut Type)

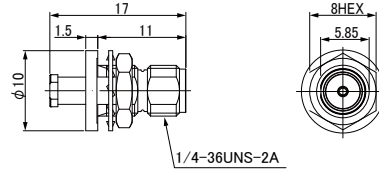

Part No.	HRS No.	Applicable Cable	Purchase Unit
HRM-200-040BPJBN(40)	CL0323-0797-2-40	φ 0.81	20pcs per bag
HRM-200-066BPJBN(40)	CL0323-0798-5-40	φ 1.13, φ 1.32	
HRM-200-088BPJBN(40)	CL0323-0804-6-40	φ 1.37, φ 1.48	

### ■ Mounting Hole Dimension

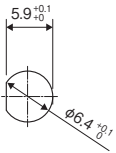

### ● Panel Jack (Nut Type, Flange Part Waterproofing)

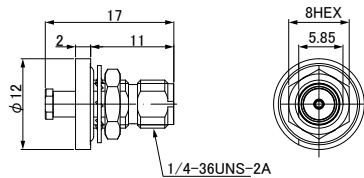

Part No.	HRS No.	Applicable Cable	Purchase Unit
HRM-200-040WBPJBN	CL0323-0945-8-00	φ 0.81	20pcs per bag
HRM-200-066WBPJBN	CL0323-0946-0-00	φ 1.13, φ 1.32	
HRM-200-088WBPJBN	CL0323-0920-7-00	φ 1.37, φ 1.48	

### ■ Mounting Hole Dimension

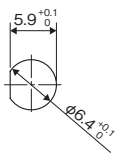

### ●Panel Jack (4 Screws Type, Flange Part Waterproofing)

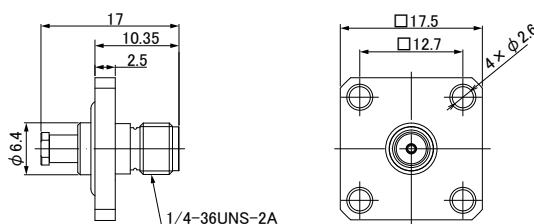

Part No.	HRS No.	Applicable Cable	Purchase Unit
HRM-200-040WPJ4BN	CL0323-0084-0-00	$\phi$ 0.81	20pcs per bag
HRM-200-066WPJ4BN	CL0323-0052-0-00	$\phi$ 1.13, $\phi$ 1.32	
HRM-200-088WPJ4BN	CL0323-0005-0-00	$\phi$ 1.37, $\phi$ 1.48	

## Receptacle

We have a variety of mounting parts for the receptacle. There are for stripline mounting (Microstrip, Tri-Plate, Suspender type), for waveguide mounting, for lead mounting, and more. Mounting methods are 4 or 2 screws type (M2.3).

### ●Straight (4 Screws Type)

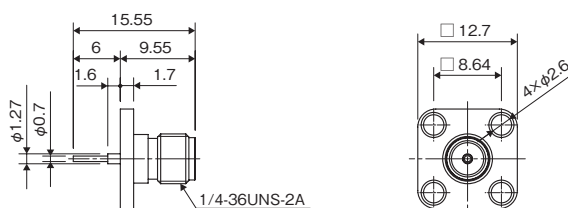

Part No.	HRS No.	Terminal Type	Purchase Unit
HRM-301(09)	CL0323-0013-0-09	Round Bar	20pcs per bag
HRM-301S	CL0323-0058-9-00	Round Bar	

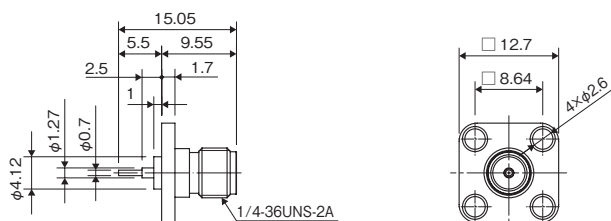

Part No.	HRS No.	Terminal Type	Purchase Unit
HRM-302(09)	CL0323-0014-3-09	Round Bar	20pcs per bag

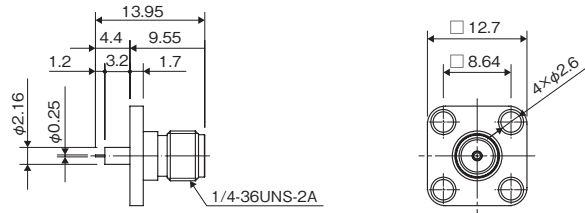

Part No.	HRS No.	Terminal Type	Purchase Unit
HRM-300-118S	CL0323-0229-0-00	Round Bar	20pcs per bag

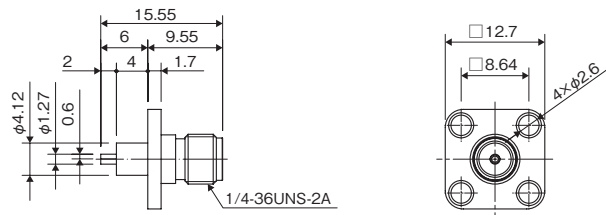

Part No.	HRS No.	Terminal Type	Purchase Unit
HRM-306(09)	CL0323-0018-4-09	Half Cut	20pcs per bag
HRM-306S	CL0323-0063-9-00	Half Cut	

(Note) There is also HRM(G)-306S that supports up to 18 GHz.



Part No.	HRS No.	Terminal Type	Purchase Unit
HRM-300-60S	CL0323-0120-0-00	Soldering	20pcs per bag



● Straight (2 Screws Type)

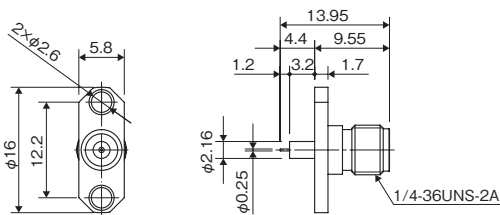

Part No.	HRS No.	Terminal Type	Purchase Unit
HRM-300-110S	CL0323-0228-7-00	Round Bar	20pcs per bag

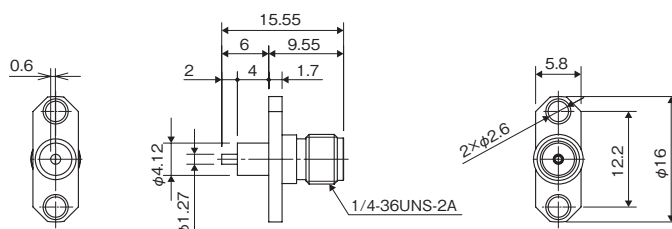

Part No.	HRS No.	Terminal	Purchase Unit
HRM-303(09)	CL0323-0015-6-09	Half Cut	20pcs per bag
HRM-303S	CL0323-0060-0-00	Half Cut	

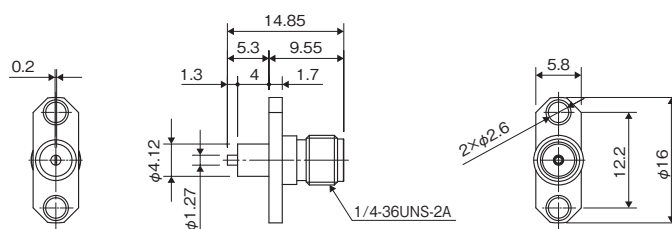

Part No.	HRS No.	Terminal Type	Remarks	Purchase Unit
HRM-300-111S	CL0323-0215-5-00	Tab	0 to18GHz	20pcs per bag

Jun.1.2024 Copyright 2024 HIROSE ELECTRIC CO., LTD. All Rights Reserved.

### ●Straight (PCB Mounted Type)

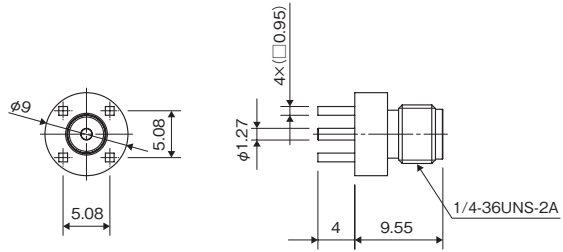

Part No.	HRS No.	Remarks	Purchase Unit
HRM-300-134B(40)	CL0323-0296-7-40	Shell : Brass	20pcs per bag

### ●Right Angle (4 Screws Type)

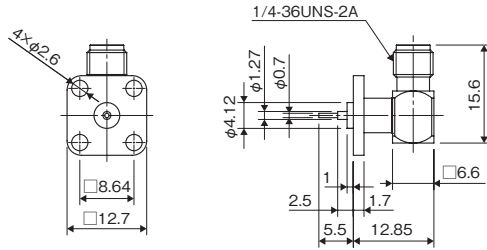
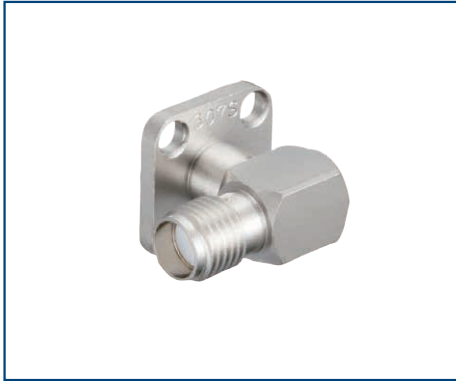

Part No.	HRS No.	Terminal Type	Purchase Unit
HRM-307(40)	CL0323-0019-7-40	Round Bar	20pcs per bag
HRM-307S(40)	CL0323-0064-1-40	Round Bar	

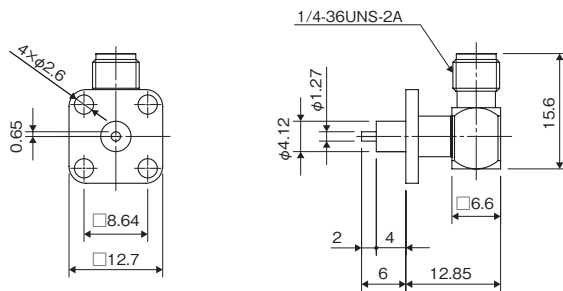

Part No.	HRS No.	Terminal Type	Purchase Unit
HRM-305(40)	CL0323-0017-1-40	Half Cut	20pcs per bag

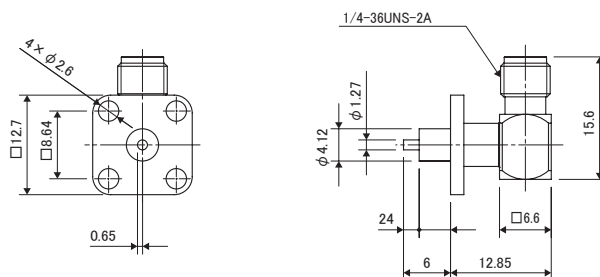

Part No.	HRS No.	Terminal Type	Purchase Unit
HRM-310S(40)	CL0323-0067-0-40	Half Cut	20pcs per bag

● Right Angle (PCB Mounted Type)

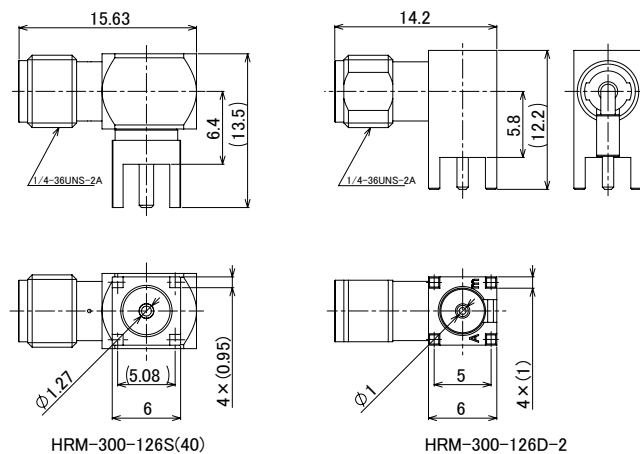

Part No.	HRS No.	Remarks	Purchase Unit
HRM-300-126S(40)	CL0323-0253-4-40		20pcs per bag
HRM-300-126D-2	CL0323-0940-4-00	Recommended, Economy Type	50pcs per tray

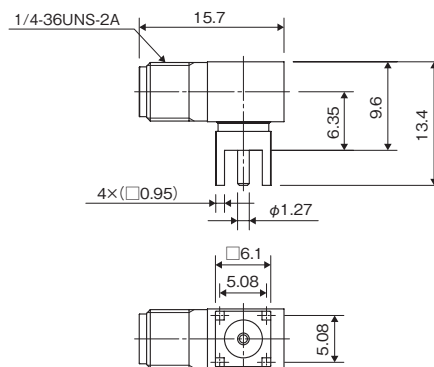

Part No.	HRS No.	Remarks	Purchase Unit
HRM-300-126B(40)	CL0323-0295-4-40	Shell : Brass	20pcs per bag

Jun.1.2024 Copyright 2024 HIROSE ELECTRIC CO., LTD. All Rights Reserved.

### ●PCB Clip Type

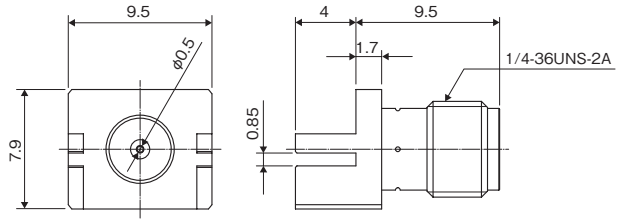
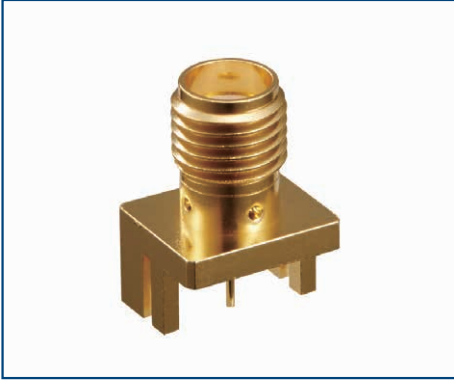

Part No.	HRS No.	Remarks	Purchase Unit
HRM(G)-300-439B	CL0323-0873-9-00	PCB Thickness : 0.8mm	20pcs per bag

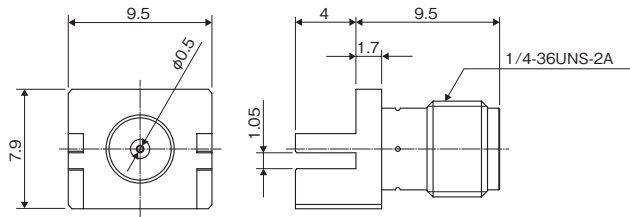
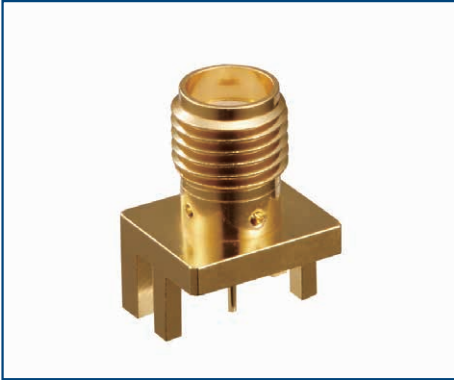

Part No.	HRS No.	Remarks	Purchase Unit
HRM(G)-300-438B	CL0323-0877-0-00	PCB thickness : 1.0mm	20pcs per bag

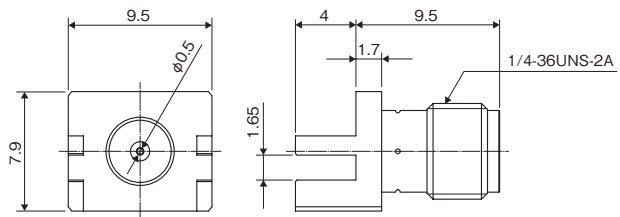

Part No.	HRS No.	Remarks	Purchase Unit
HRM(G)-300-436B	CL0323-0908-1-00	PCB thickness : 1.6mm	20pcs per bag

## Plug Receptacle (Mated Portion : Plug)

We have various type of mounting part of Plug Receptacle. There are for stripline mounting (Microstrip, Tri-Plate, Suspender type), for waveguide mounting, for lead mounting, and more. Mounting methods are 4 or 2 screws type (M2.3).

### ●Straight (4 Screw Type)

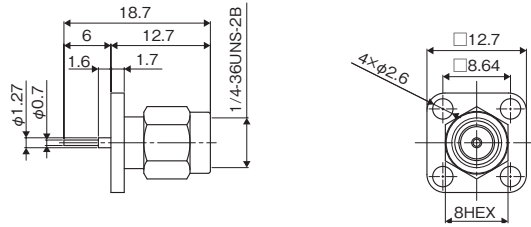

Part No.	HRS No.	Terminal Type	Purchase Unit
HRM-401S(40)	CL0323-0070-4-40	Round Bar	20pcs per bag

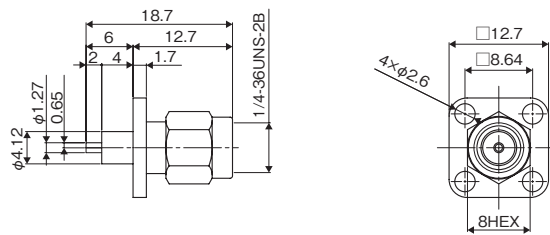

Part No.	HRS No.	Terminal Type	Purchase Unit
HRM-406(40)	CL0323-0026-2-40	Half Cut	20pcs per bag
HRM-406S(40)	CL0323-0075-8-40	Half Cut	

### ●Right Angle (4 Screws Type)

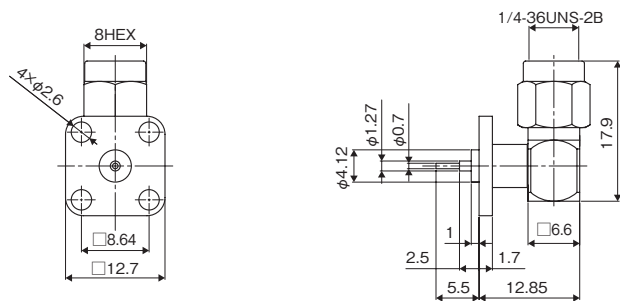

Part No.	HRS No.	Terminal Type	Purchase Unit
HRM-407S(40)	CL0323-0076-0-40	Round Bar	20pcs per bag

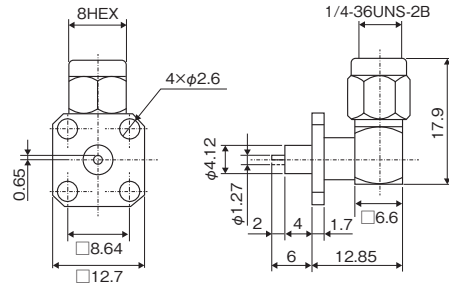

Part No.	HRS No.	Terminal Type	Purchase Unit
HRM-405S(40)	CL0323-0074-5-40	Half Cut	20pcs per bag

## In-Line Adapter

### ● Straight (Mated Portion : Plug - Plug)

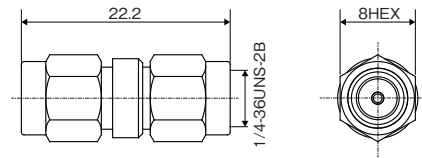

Part No.	HRS No.	Purchase Unit
HRM-502(40)	CL0323-0030-0-40	20pcs per bag
HRM-502S(40)	CL0323-0157-0-40	

### ● Straight (Mated Portion : Jack - Jack)

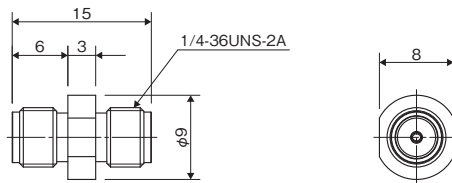

Part No.	HRS No.	Purchase Unit
HRM-501(09)	CL0323-0029-0-09	20pcs per bag
HRM-501S	CL0323-0156-8-00	

●Right Angle (Mated Portion : Plug - Jack)

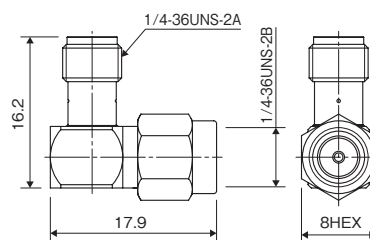

Part No.	HRS No.	Purchase Unit
HRM-503(40)	CL0323-0031-2-40	20pcs per bag
HRM-503S(40)	CL0323-0112-2-40	

●Panel (Mated Portion : Jack - Jack)

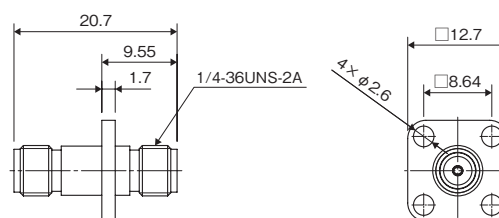

Part No.	HRS No.	Remarks	Purchase Unit
HRM-513(09)	CL0323-0034-0-09	0 to 18GHz	20pcs per bag
HRM-513S	CL0323-0078-6-00		
HRM-513SV	CL0323-0657-3-00	Impedance Matching Type 0 to 20GHz	

Jun.1.2024 Copyright 2024 HIROSE ELECTRIC CO., LTD. All Rights Reserved.

### ● Panel (Nut Type) (Mated Portion : Jack - Jack)

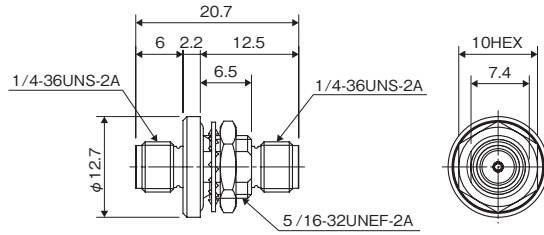

Part No.	HRS No.	Remarks	Purchase Unit
HRM-500-1SV(40)	CL0323-0659-9-40	Impedance Matching Type 0 to 20GHz	20pcs per bag

### ■ Mounting Hole Dimension

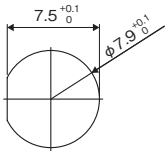

### ● Straight (Mated Portion : Jack - SMA-Compatible Push-on Plug)

Significantly reduces the man-hours required to inspect plug harness products.

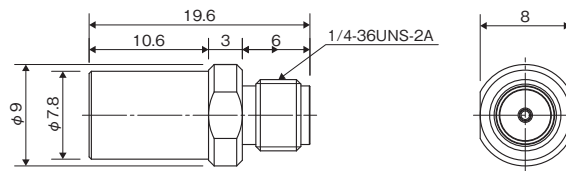

Part No.	HRS No.	Purchase Unit
HRMP(PO)-HRMJ	CL0323-0741-8-00	20pcs per bag

(Note) This adapter converts the mating part of a plug into a push-on type plug.  
It can be used as a measuring tool as the man-hours required for mating with the jack can be significantly reduced.



## Short Connector

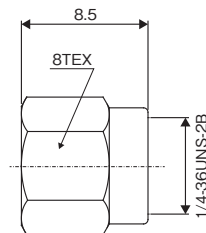

Part No.	HRS No.	Purchase Unit
HRM-504(09)	CL0323-0032-5-09	20pcs per bag

## Dust Cap

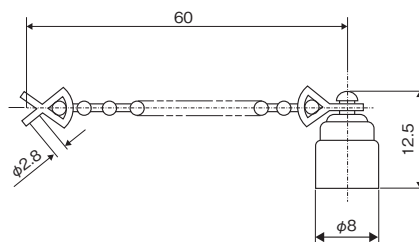
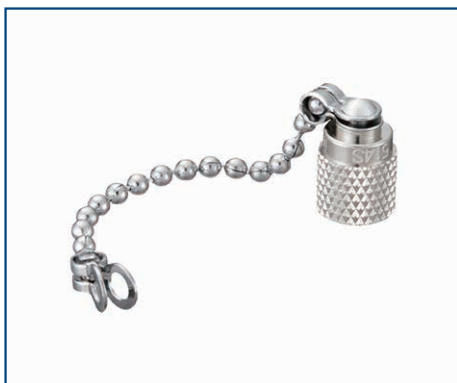

Part No.	HRS No.	Purchase Unit
HRM-514(40)	CL0323-0038-1-40	20pcs per bag
HRM-514S(40)	CL0323-0150-1-40	

## Termination Tools

Below are a table giving an overview of the tools used for connecting the wiring of the HRM series and a table listing the tools used for typical products.

Tool Name	Tool Overview
HRM-T-1	Positioning Tool for Center Contact of Female Joint
HRM-T-2	Positioning Tool for Center Contact of Male Joint

HRM-T-1  
Locator for Jack

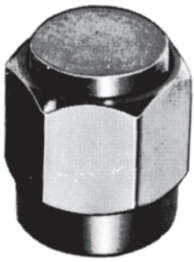

HRM-T-2  
Locator for Plug

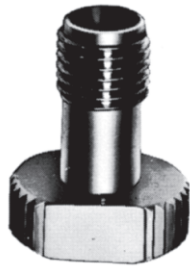

Type	Part No.	Termination Tools	HRS No.	Overview
Straight Plug (Common to Termination Tools)	SMA(R)-200-040PBN(40)	HRM-200/SO-MD	CL0902-3192-6-00	External Solder Receiver
	SMA(R)-200-066PBN(40)	HRM-200/SO-MD2	CL0902-3199-5-00	Center Solder Receiver
	SMA(R)-200-088PBN(40)	HRM-200-PBN/CV-MD	CL0902-3198-2-00	Cord Tube Press-fit
Straight Jack (Common to Termination Tools)	SMA(R)-200-040JBN(40)	HRM-200/SO-MD	CL0902-3192-6-00	External Solder Receiver
	SMA(R)-200-066JBN(40)	HRM-200/SO-MD2	CL0902-3199-5-00	Center Solder Receiver
	SMA(R)-200-088JBN(40)	HRM-200-JBN/CV-MD	CL0902-3195-4-00	Cord Tube Press-fit
Panel Jack, 4 Screws Type (Common to Termination Tools)	SMA(R)-200-040PJ4BN(40)	HRM-200/SO-MD	CL0902-3192-6-00	External Solder Receiver
	SMA(R)-200-066PJ4BN(40)	HRM-200/SO-MD2	CL0902-3199-5-00	Center Solder Receiver
	SMA(R)-200-088PJ4BN(40)	HRM-200-PJ4BN/CV-MD	CL0902-3197-0-00	Cord Tube Press-fit
Panel Jack, 2 Screws Type (Common to Termination Tools)	SMA(R)-200-040PJ2BN(40)	HRM-200/SO-MD	CL0902-3192-6-00	External Solder Receiver
	SMA(R)-200-066PJ2BN(40)	HRM-200/SO-MD2	CL0902-3199-5-00	Center Solder Receiver
	SMA(R)-200-088PJ2BN(40)	HRM-200-PJ2BN/CV-MD	CL0902-3196-7-00	Cord Tube Press-fit
Panel Jack, Nut Type (Common to Termination Tools)	SMA(R)-200-040BPJBN(40)	HRM-200/SO-MD	CL0902-3192-6-00	External Solder Receiver
	SMA(R)-200-066BPJBN(40)	HRM-200/SO-MD2	CL0902-3199-5-00	Center Solder Receiver
	SMA(R)-200-088BPJBN(40)	HRM-200-BP2BN/CV-MD	CL0902-3194-1-00	Cord Tube Press-fit
Panel Jack, Waterproof Nut Type (Common to Termination Tools)	SMA(R)-200-040WBPJBN	HRM-200/SO-MD	CL0902-3192-6-00	External Solder Receiver
	SMA(R)-200-066WBPJBN	HRM-200/SO-MD2	CL0902-3199-5-00	Center Solder Receiver
	SMA(R)-200-088WBPJBN	HRM-200-BP2BN/CV-MD	CL0902-3194-1-00	Cord Tube Press-fit

## Technical Guidance

### ● S-Type Recommendations

S-Type products are on passivated stainless steel, which is the material of the outer housing.

Passivated finish is a surface treatment that is etched with hydrofluoric acid to reduce iron particles on the surface of stainless steel and then forms a thin oxide film that does not affect conductivity.

This treatment makes the stainless steel more resistant to corrosion.

In aluminum combination, the potential difference between them can be as high as 0.9V. It may induce electrical corrosion depending on the environmental conditions.

The S-Type is not only highly resistant to electrical corrosion, but also superior to gold plated type in terms of corrosion resistance as evidenced by salt spray's acceleration testing in a 5000 hour standing test in an area with a high concentration of sulfite gas.

As for other advantages, there is no drawback that gold plating powder accumulates on the surface of the joint, which is seen in gold plating type. Furthermore, it does not use expensive gold, so we offer it at a lower price than gold plating type.

In order to make better use of these advantages, the S-Type will be standardised in preference to the gold-plated type in the future.

In principle, the S-Type surface treatment is passivated finish, in the following cases, other finish will be used.

(1) For right angle type, Nickel Plated is applied because the surface of stainless steel is discolored significantly by the heat applied during the brazing.

In this case, the potential difference with aluminum is 0.6 V.

(2) In the case of semi-rigid cable connectors (HRM100 to 199), products where the external conductor of the cable is soldered (e.g. the shell of HRM-101S( 09)) are gold-plated for solderability.

### ● High-Frequency Performance

#### 1. Frequency Range

The coaxial transmission line interruption frequency can be obtained by the following formula:

$$f_{\text{CUT}} = \frac{191 \times 10^{11}}{\sqrt{\epsilon_0} (d_1 + d_2)} \text{ (Hz)}$$

$d_1$  = Center Contact Outer Diameter (Unit : mm)

$d_2$  = External Contact Outer Diameter (Unit : mm)

$\epsilon_0$  = Insulator (PTFE) 's Relative Permittivity

Using this formula, the cutoff frequency of the HRM series is calculated to be 24.5 GHz. However, this value is only a theoretical value for an ideal transmission line, and the upper limit of industrially usable frequency considering Voltage Standing Wave Ratio is about 18 GHz.

Currently, the guaranteed frequency limit of the HRM series is 12.4 GHz, which is lower than 18 GHz, but some products have achieved satisfactory results up to 18 GHz as a typical value, so please contact us if you wish to use the product above 12.4 GHz.

#### 2. Insertion Loss

The insertion loss of the HRM series can be determined by

$$\text{Loss} \leq 0.03 \sqrt{f(\text{GHz})} \quad (\text{dB})$$

Using this formula, the insertion loss at 12.4 GHz is calculated to be 0.1 dB. That is, the insertion loss of the HRM series is below 0.1 dB over the entire guaranteed bandwidth. This value has been fully confirmed by experiments.

#### 3. High Frequency Leakage

The high-frequency leakage of the HRM series has a performance of more than 100 dB within the guaranteed frequency range under two conditions: tightening the coupling to the specified torque and sufficient screw fastening between the set and the connector.

#### 4. S-Type Performance

Due to the surface effect, the gold-plated type has low conductor losses because the electromagnetic field is concentrated in the gold-plated area. On the other hand, the S type has higher conductor losses because they are distributed in the stainless steel section.

However, it can be almost ignored because of the short transmission line length. (Typical length of the transmission line when a receptacle and plug receptacle are connected together is 15.2 mm.).

Also, passivated finish roughens the surface, which is small enough to exceed the finish accuracy of the cut, so it has no impact on performance.

#### ● Coupling Tightening Torque

---

The appropriate tightening torque for HRM series couplings is 0.6 to 1.0 Nm (6 to 10 kg/cm).

Moreover, the optimum tightening torque within this range is 0.6 Nm (6 kg/cm) when no vibration is applied except during transportation, and 1.0 Nm (10 kg/cm) when vibration is applied.

The reason for setting the range of 0.6 to 1.0 Nm (6 to 10 kg/cm) is that, first, a vibration test under the assumed conditions of vibration during transport confirmed that tightening to 0.3 Nm (3 kg/cm) would not cause loosening.

We doubled the safety factor and set the range of 0.6 Nm (6 kg/cm), and set the upper limit of 1.0 Nm (10 kg/cm) based on the dimensional change in the outer diameter of the male joint's  $\phi 4.56 \pm 0.02$  part.

The tightening torque for the HRM series couplings is thus limited, and failure may occur if the torque is outside this range.

When tightening, use a torque spanner of 8 mm x 0.6 Nm (6 kg / cm) or 8 mm x 1.0 Nm (10 kg / cm).

## Conversion Adapter List

For more information, please see our company BWA series.

Joint 1		Joint 2		Part No.	HRS No.	Remarks	Purchase Unit
Series Name	Joint Part	Series Name	Joint Part				
SMA (HRM)	Plug	N	Plug	HRM-555S(40)	CL0311-0125-4-40		5pcs per bag
			Jack	HRM-553S	CL0311-0121-3-00		
			HRM-557S	CL0311-0138-6-00	Panel Attachment Type		
	Jack		Plug	HRM-554S(40)	CL0311-0123-9-40		
			Jack	HRM-552S	CL0311-0119-1-00		
			HRM-556S	CL0311-0127-0-00	Panel Attachment Type		
	Plug	BNC	Plug	HRM-519(40)	CL0311-0101-6-40		20pcs per bag
			Jack	HRM-517(40)	CL0311-0099-6-40		
	Jack		Plug	HRM-518(40)	CL0311-0100-3-40		5pcs per bag
			Jack	HRM-516(40)	CL0311-0102-9-40		
	Plug	S	Plug	HRM-509(31)	CL0311-0093-0-31		20pcs per bag
			Jack	HRM-512S(40)	CL0311-0144-9-40	Panel Attachment Type	
	Jack		Jack	HRM-506(40)	CL0311-0090-1-40		20pcs per bag
				HRM-511(40)	CL0311-0094-2-40	Panel Attachment Type	
	Jack	TNC	Jack	HRMJ-TNCJ-PA(40)	CL0311-0202-3-40	Panel Attachment Type	5pcs per bag
	Jack	UM	Plug	UM.P-HRM.J(40)	CL0311-0176-5-40		
			Jack	HRMJ-UMJ(40)	CL0311-0164-6-40		
	Plug	POB	Plug	HRMP-POBP-1(40)	CL0311-0169-0-40		20pcs per bag
			Jack	HRMP-POBJ	CL0311-0152-7-00		
	Jack		Plug	HRMJ-POBP(40)	CL0311-0151-4-40		
			Jack	HRMJ-POBJ(40)	CL0311-0149-2-40		
		HRMJ-POBJ-PA(40)	CL0311-0150-1-40	Panel Attachment Type			
	Plug	POD	Jack	HRM.P-POD.J(40)	CL0311-0177-8-40		
			Plug	HRMJ-PODP(40)	CL0311-0157-0-40		
	Plug	PO6	Jack	HRMP-PO6J(40)	CL0311-0172-4-40		
			Plug	HRMJ-PO6P(40)	CL0311-0173-7-40		
	Plug	H.FL	Jack	HRMP-H.FLJ(40)	CL0311-0232-4-40	For Harness Products Inspection	
			Jack	HRMJ-H.FLP-3(40)	CL0311-0264-0-40	For Receptacle Inspection	
	Plug	E.FL	Jack	HRMP-E.FLJ(40)	CL0311-0279-8-40	For Harness Products Inspection	
			Jack	Plug	HRMJ-E.FLP(40)	CL0311-0278-5-40	For Receptacle Inspection
HRMJ-E.FLP-5(40)	CL0311-0294-1-40				For Receptacle Autpmatic Inspection		
Plug	U.FL		Jack	HRMP-U.FLJ(40)	CL0311-0300-2-40	For Harness Products Inspection	
		Jack	HRMJ-U.FLP(40)	CL0311-0301-5-40	For Receptacle Inspection		

## While Taking into Consideration

Specifications mentioned in this catalog are reference values.

When considering to order or use this product, please review the Drawing and Product Specifications sheets.

Use an appropriate cable when using the connector in combination with cables.

If considering usage of a non-specified cable, please contact your sales representative.

If assembly process is done by jigs & tools which are not identified by Hirose, the warranty of the product may be affected.

If considering usage for below mentioned applications, please contact your sales representative.

In cases where the application will demand a high level of reliability, such as automotive, medical instruments, public infrastructure, aerospace/defense etc. Hirose must review before assurance of reliability can be given.

**HIROSE****HIROSE ELECTRIC CO.,LTD.**2-6-3 Nakagawa Chuoh, Tsuzuki-Ku, Yokohama-Shi 224-8540, JAPAN  
<https://www.hirose.com>

HRM-TM Series

# MIL/IEC Standard SMA Connector Non-Reflective Terminator



SMA



MIL Standard

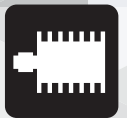

Terminator



Jun.1.2024 Copyright 2024 HIROSE ELECTRIC CO., LTD. All Rights Reserved.





## Materials / Finish

Component	Material	Finish
Exterior (Note)	Stainless Steel	Nickel Plating
Insulator	PTFE	—
Male Contact	Brass	Gold Plating
Female Contact	Beryllium Copper	Gold Plating
Outer Conductor	Brass	Nickel Plating
Coupling (Note)	Stainless Steel	Passivated
Radiator	Aluminum	Black Almite
Resistance	Metal Film	—

(Note) Exterior and coupling of HRM-601(50), HRM-602(50) and HRM-603(50) are gold plated.

## Product Number Structure

Refer to the chart below when determining the product specifications from the product number.

### HRM - [ ] [ ]

①      ②      ③

① Series Name	HRM	③ Power	0.5 : 1/2W 2 : 2W
② Non-Reflective Terminator	600 to 699 (Note) TM		

(Note) S is added for S type.

## High-Frequency Performance

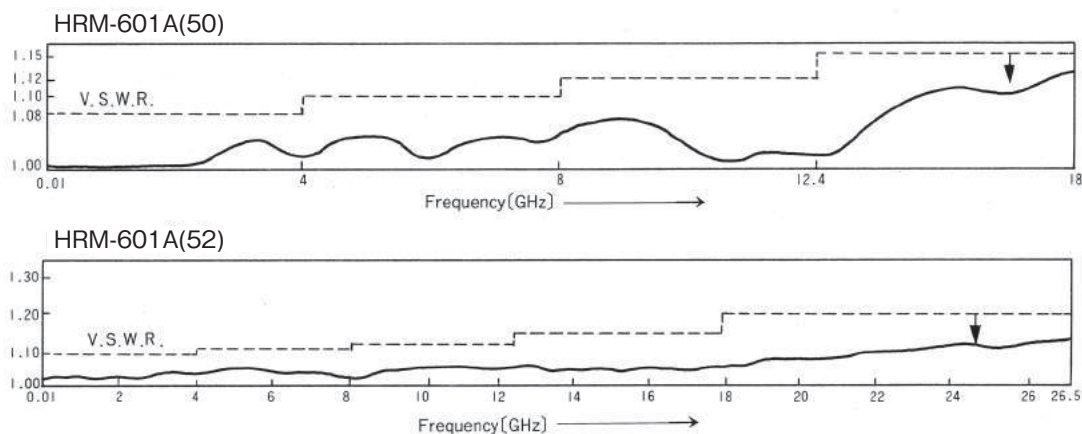

## Non-Reflective Terminator

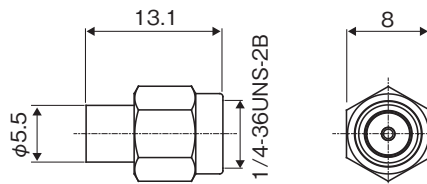

Part No.	HRS No.	Applicable Frequencies	V.S.W.R. (Max)				Power (W)	Connector Type	Purchase Unit
			0 to 4GHz	4 to 8GHz	8 to 12.4GHz	12.4 to 18GHz			
HRM-601(50)	CL0353-0057-8-50	0 to 18GHz	1.08	1.10	1.12	1.15	1/4	Plug	20pcs per bag
HRM-601S(50)	CL0353-0060-2-50								

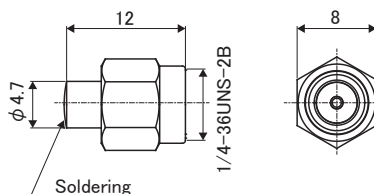

Part No.	HRS No.	Applicable Frequencies	V.S.W.R. (Max)					Power (W)	Connector Type	Purchase Unit
			0 to 4GHz	4 to 8GHz	8 to 12.4GHz	12.4 to 18GHz	18 to 26.5GHz			
HRM-601A(50)	CL0353-0017-3-50	0 to 18GHz	1.08	1.10	1.12	1.15	—	1/4	Plug	20pcs per bag
HRM-601A(52)	CL0353-0017-3-52	0 to 26.5GHz					1.2			

(Note) HRM-601S(50) type without cap.

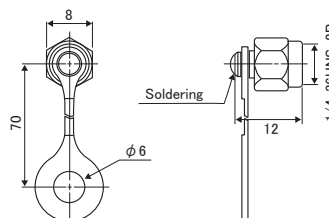

Part No.	HRS No.	Applicable Frequencies	V.S.W.R. (Max)				Power (W)	Connector Type	Purchase Unit
			0 to 4GHz	4 to 8GHz	8 to 12.4GHz	12.4 to 18GHz			
HRM-601D(50)	CL0 353-0064-3-50	0 to 18GHz	1.08	1.10	1.12	1.15	1/4	Plug	20pcs per bag

(Note 1) With Coupling

(Note 2) When attaching a connecting wire to the jack side, use one with a vertical dimension of at least 6.6 mm from the mounting surface.

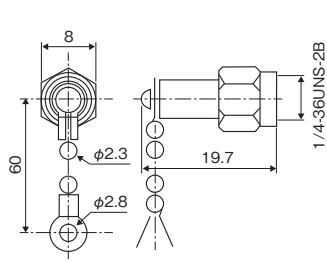
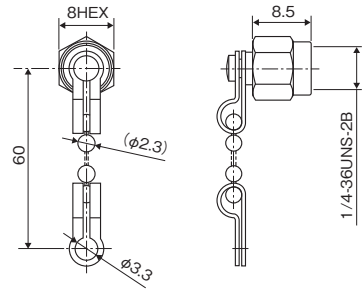

 HRM-603(50)  
 HRM-603S(50)

HRM-601JW(51)

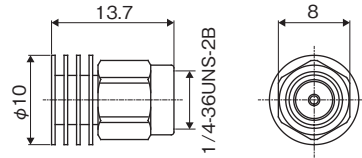
Part No.	HRS No.	Applicable Frequencies	V.S.W.R. (Max)				Power (W)	Connector Type	Purchase Unit
			0 to 4GHz	4 to 8GHz	8 to 12.4GHz	12.4 to 18GHz			
HRM-603(50)	CL0353-0059-3-50	0 to 18GHz	1.08	1.10	1.12	1.15	1/4	Plug	20pcs per bag
HRM-603S(50)	CL0353-0062-8-50								
HRM-601JW(51)	CL0353-0169-1-51								

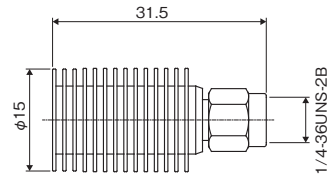

Part No.	HRS No.	Applicable Frequencies	V.S.W.R. (Max)				Power (W)	Connector Type	Purchase Unit
			0 to 4GHz	4 to 8GHz	8 to 12.4GHz	12.4 to 18GHz			
HRM-TMP-05(50)	CL0353-0004-1-50	0 to 18GHz	1.08	1.10	1.12	1.15	1/2	Plug	20pcs per bag



Part No.	HRS No.	Applicable Frequencies	V.S.W.R. (Max)				Power (W)	Connector Type	Purchase Unit
			0 to 2GHz	2 to 4GHz	4 to 8GHz	8 to 18GHz			
HRM-TMP-2(40)	CL0353-0005-4-40	0 to 18GHz	1.10	1.15	1.20	1.25	2	Plug	20pcs per bag

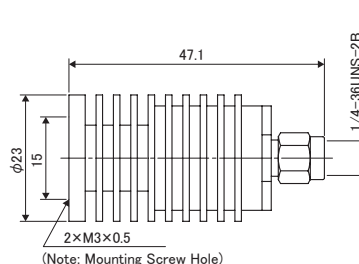

Part No.	HRS No.	Applicable Frequencies	V.S.W.R. (Max)		Power (W)	Connector Type	Purchase Unit
			0 to 10GHz	10 to 18GHz			
HRM-TMP-5-2(40)	CL0353-0088-1-40	0 to 18GHz	1.20	1.30	5	Plug	1pc per bag

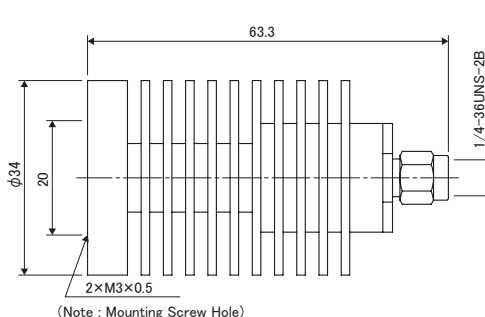

Part No.	HRS No.	Applicable Frequencies	V.S.W.R. (Max)		Power (W)	Connector Type	Purchase Unit
			0 to 10GHz	10 to 18GHz			
HRM-TMP-10-2(40)	CL0353-0089-4-40	0 to 18GHz	1.20	1.30	10	Plug	1pc per bag

Jun.1.2024 Copyright 2024 HIROSE ELECTRIC CO., LTD. All Rights Reserved.

## While Taking into Consideration

Specifications mentioned in this catalog are reference values.

When considering to order or use this product, please review the Drawing and Product Specifications sheets.

Use an appropriate cable when using the connector in combination with cables.

If considering usage of a non-specified cable, please contact your sales representative.

If assembly process is done by jigs & tools which are not identified by Hirose, the warranty of the product may be affected.

If considering usage for below mentioned applications, please contact your sales representative.

In cases where the application will demand a high level of reliability, such as automotive, medical instruments, public infrastructure, aerospace/defense etc. Hirose must review before assurance of reliability can be given.

## HRM-TM-Flange Series

# MIL/IEC Standard SMA Connector Non-Reflective Terminator with Flange



SMA



MIL Standard

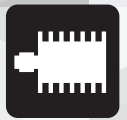

Terminator



Jun.1.2024 Copyright 2024 HIROSE ELECTRIC CO., LTD. All Rights Reserved.



## Materials / Finish

Component	Material	Finish
Exterior (Note)	Brass	Nickel Plating
Insulator	PTFE	—
Contact	Brass	Gold Plating
Resistance	Metal Film	—

(Note) Exterior of HRM-TM-025 is stainless steel, gold plated.

## Product Number Structure

Refer to the chart below when determining the product specifications from the product number.

### HRM - TM - 025 - 17 (50)

- ①      ②      ③      ④      ⑤

① Flange Type	HRM Series	④ Identification No.	
② TM	Non-Reflective Terminator	⑤ Specification	(50) : RoHS Compliant
③ Power	025 : 1/4W, 1W		

## High-Frequency Performance

### ● HRM-TM-025-17(50)

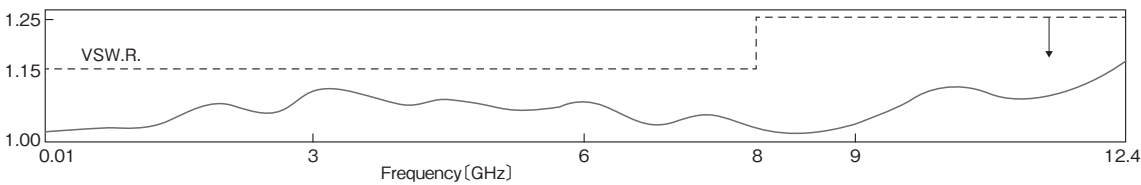

## Non-Reflective Terminator with Flange

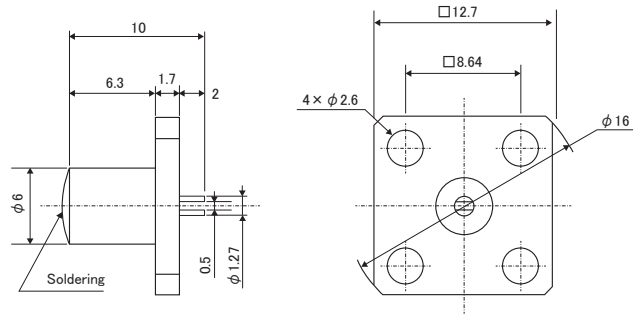

HRM-TM-025-17(50)

Part No.	HRS No.	Frequency (GHz)	V.S.W.R. (Max)	Power (W)	DC Resistance Value ( $\Omega$ )	Temperature Rise ( $^{\circ}\text{C}$ Max)	Operating Temperature ( $^{\circ}\text{C}$ )	Heat Sink Temperature ( $^{\circ}\text{C}$ Max)	Contact Fixed Force ( $\mu\text{N}\cdot\text{m}$ )	Purchase Unit
HRM-TM-025-17(50)	CL0353-0016-0-50	0 to 8 8 to 12.4	1.15 1.25	1	$50 \pm 2$	40	-30 to + 65	+ 65	392	20pcs per bag

(Note) This product contains Beryllia. When disposing of the product, follow the relevant laws and regulations.

## While Taking into Consideration

Specifications mentioned in this catalog are reference values.

When considering to order or use this product, please review the Drawing and Product Specifications sheets.

Use an appropriate cable when using the connector in combination with cables.

If considering usage of a non-specified cable, please contact your sales representative.

If assembly process is done by jigs & tools which are not identified by Hirose, the warranty of the product may be affected.

If considering usage for below mentioned applications, please contact your sales representative.

In cases where the application will demand a high level of reliability, such as automotive, medical instruments, public infrastructure, aerospace/defense etc. Hirose must review before assurance of reliability can be given.

## HRM(G) Series

# Excellence Impedance Matching SMA Connector



RF



SMA



User Friendly



Jun.1.2024 Copyright 2024 HIROSE ELECTRIC CO., LTD. All Rights Reserved.





## Features

---

### 1. Support High-Frequency Band

Internal design optimization enables impedance matching.

### 2. Conforms to SMA Standard

Compatible with HRM Series

### 3. Available in Frequency Band up to 28GHz

### 4. Solderless Mounted

High speed transmission evaluation board receptacle is screw-mounted.

### 5. Board Mounting Thickness

High speed transmission evaluation board receptacle mounting is possible with boards larger than 0.7mm.

### 6. PCB Mounting Direction

High speed transmission evaluation board receptacle is available in two variations: PCB horizontal (end-launch) and PCB vertical.

### 7. RoHS2 Compliant

## Applications

Data transmission measurement, cable or radio communication equipment, broadcasting equipment, radar equipment, and contact for in-flight wiring, unit-to-unit connection, and input/output of components constituting the equipment in electronic measuring device, etc.

## Product Specifications

Nominal Characteristic Impedance	50 $\Omega$	Operating Temperature	-55 to +85°C
Rated Voltage	330V AC	Operating Relative Humidity	95% Max.
Rated Frequency	0 to 18GHz		

Items	Specifications	Conditions
Contact Resistance	Center : 4m $\Omega$ Max. External : 4m $\Omega$ Max.	Measured at 100mA Max.
Insulation Resistance	5000M $\Omega$ Min.	Measured at 500V DC
Withstanding Voltage	No flashover or insulation breakdown	1000V AC for 1 min.
V.S.W.R.*	See below	See below
Pulling force of Female Contact	0.3N Min.	Measured with $\phi$ 0.9017 pin gauge
Center Contact Fixing Torque	16.7mN·m Min.	Measured with applicable connector
Coupling Tightening Torque	0.6 to 1.0Nm	Measured with applicable connector
Coupling Fixed Strength	490N Min.	Measured with applicable connector
Mating Durability	Contact Resistance 6m $\Omega$ Max.	500 cycles
Vibration Resistance	No electrical discontinuity of 1 $\mu$ s or more No damage, cracks or part dislocation.	Frequency : 10 to 2000Hz, single amplitude of 0.75mm Acceleration of 196m/s <sup>2</sup> , 4 hours in the direction of each of the 3 axis
Shock Resistance	No electrical discontinuity of 1 $\mu$ s or more No damage, cracks or part dislocation.	Acceleration of 1960m/s <sup>2</sup> , 6ms duration Sine halfwave : 3 times each in 3 axial both directions
Humidity Resistance	Insulation resistance 100M $\Omega$ Min. (in a high humidity environment) Insulation Resistance 5000M $\Omega$ Min. (in a dry environment)	Left for 10 cycles (240 hours) in an environment with the temperature ranging from +25 to +65°C and the humidity ranging from 90 to 98%.
Thermal Shock	No damage, cracks or part dislocation.	Temperature : -65 $\rightarrow$ +5 to +35 $\rightarrow$ +85 $\rightarrow$ +5 to +35°C Time : 30 $\rightarrow$ 5 $\rightarrow$ 30 $\rightarrow$ 5 minutes for 5 cycles
Corrosion Resistance	Satisfying the V.S.W.R. Standard	Continuous 48 hour cycle in 5% salt water solution

(Note) Information contained in this catalog represents general requirements for this Series. Contact us for the drawings and specifications for a specific part number shown.

\* V.S.W.R. (Voltage Standing Wave Ratio) Measurement System

V.S.W.R. of HRM Series is as shown below.

The above V.S.W.R. specification values were measured using the measurement system shown below.

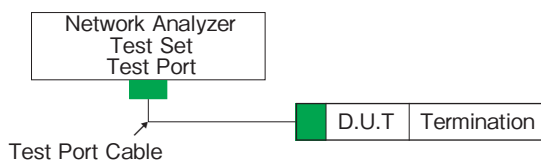

(Note1) The cable connector is measured with the connector attached to the applicable cable.

(Note2) Receptacle and plug receptacle are measured with the measuring adapter installed.

## Materials / Finish

Part	Material	Finish
Shell	Brass	Gold Plating/Nickel Plating
Insulator	PTFE	—
Contact	Beryllium Copper	Gold Plating

## Receptacle (Frequency up to 18GHz)

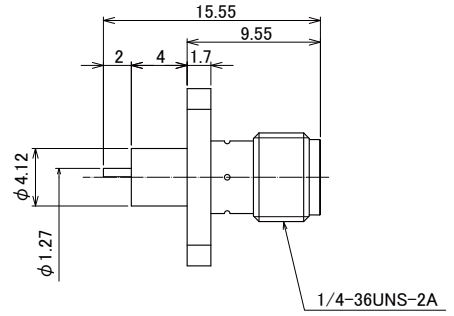
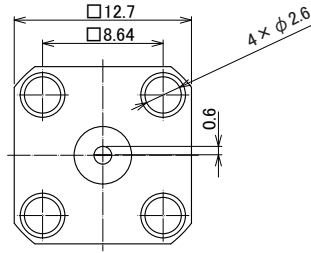

Part No.	HRS No.	Terminal Type	Remarks
HRM(G)-306S	CL0323-0823-0-00	Half Cut	0 to 18GHz compatible HRM-306S compatible

## Receptacle for High Speed Transmission Evaluation Board Ports (Frequency up to 28GHz)

This product is a solderless mounted connector for prototype evaluation of high speed transmission boards. It is not recommended for use in actual commercial equipment.

### ●End Launch Receptacle

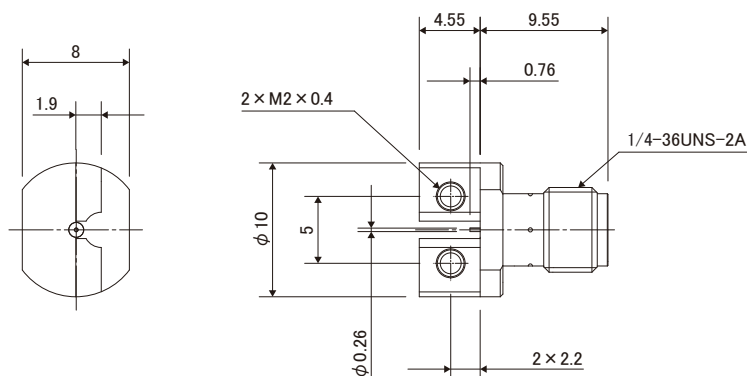

Part No.	HRS No.	Frequency	Mounting Screw	Purchase Unit
HRM(G)-300-467B-1	CL0323-0937-0-00	0 to 28GHz	For No.2-64UNF-2A	20pcs per bag
HRM(G)-300-467B-2	CL0323-0923-5-00	0 to 28GHz	For M2 × 0.4	
HRM(G)-300-467B-2(01)	CL0323-0923-5-01	0 to 28GHz	M2 × 0.4 included	

### V.S.W.R. (Max.)

0 to 20GHz	20 to 28GHz
1.4	1.7

### ◆Frequency Characteristics (TYPICAL)

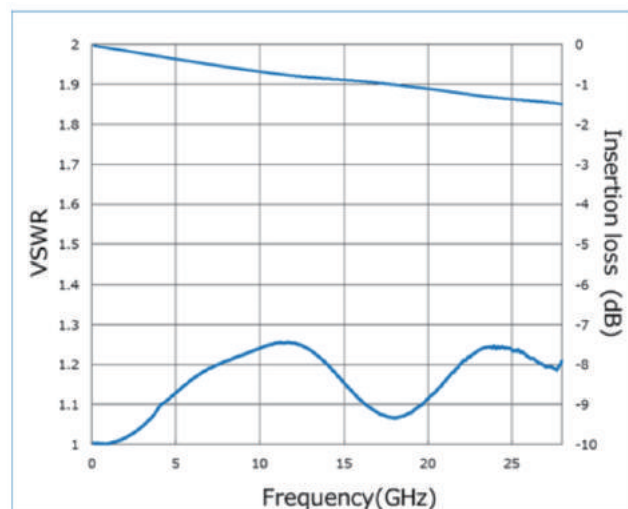

\*Connector+Board Line : 10mm

## ● Straight Receptacle

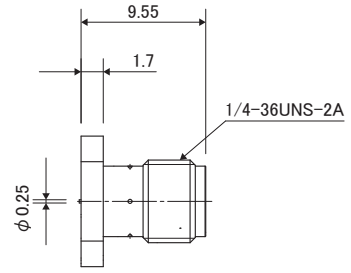
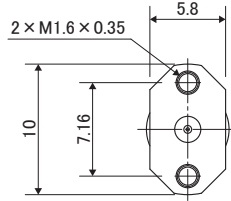

Part No.	HRS No.	Frequency	Mounting Screw	Purchase Unit
HRM(G)-300-468B-1	CL0323-0924-8-00	0 to 28GHz	For No.0-80UNF-2A	20pcs per bag
HRM(G)-300-468B-1(01)	CL0323-0924-8-01	0 to 28GHz	No.0-80UNF-2A included	

## V.S.W.R. (Max.)

0 to 18GHz	18 to 20GHz	20 to 28GHz
1.4	1.5	1.7

## ◆ Frequency Characteristics (TYPICAL)

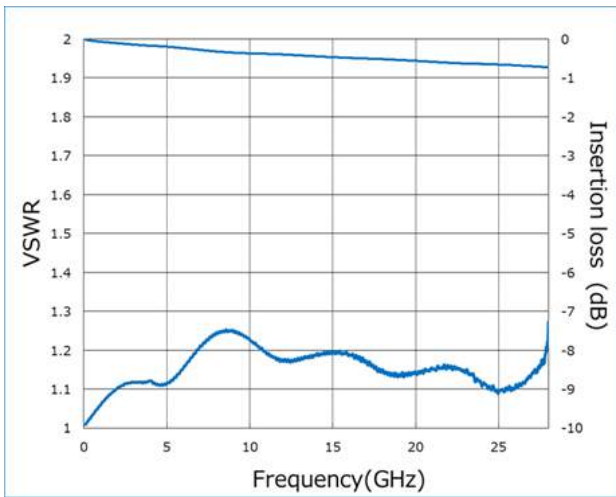

\*Connector+Board Line : 12.5mm

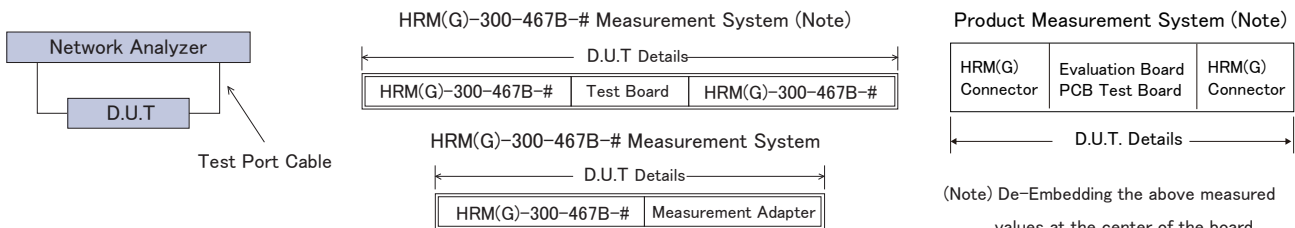

(Note) HRM(G)-300-467B-# were mounted to a 50Ω glass epoxy board and measurements were conducted.

## Material

● HRM(G)-300-467B-#, HRM(G)-300-468B-#

Part	Component	Material
R Shell	Brass	Gold Plating
Insulator	PTFE	-
Female Contact	Beryllium Copper	Gold Plating

## Plug for Micro-Coaxial Cable (Frequency up to 12GHz)

Plugs can be ordered only as terminated cable assemblies.

### ● Straight Plug

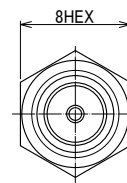
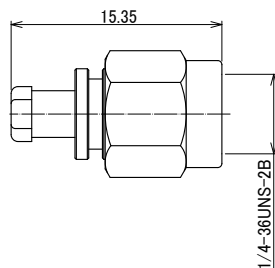

Part No.	HRS No.	Applicable Cable
HRM(G)-200-040PBN	CL0323-0913-0-00	φ 0.81
HRM(G)-200-066PBN	CL0323-0914-0-00	φ 1.13, φ 1.32
HRM(G)-200-088PBN	CL0323-0941-0-00	φ 1.37, φ 1.48

## Jack for Micro-Coaxial Cable (Frequency up to 12GHz)

Jacks can be ordered only as terminated cable assemblies.

### ● Straight Jack

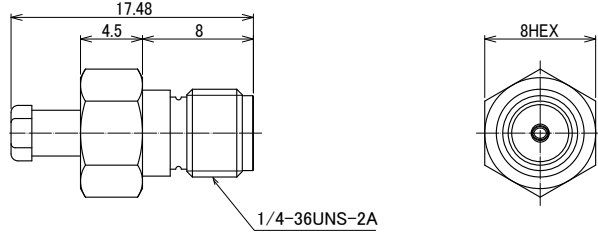

Part No.	HRS No.	Applicable Cable
HRM(G)-200-040JBN	CL0323-0958-0-00	φ 0.81
HRM(G)-200-066JBN	CL0323-0959-0-00	φ 1.13, φ 1.32
HRM(G)-200-088JBN	CL0323-0960-0-00	φ 1.37, φ 1.48

### ● Panel Jack (4 Screws Type)

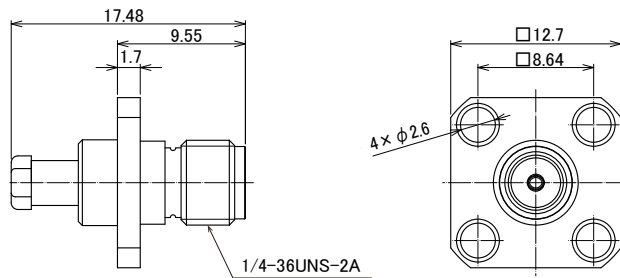

Part No.	HRS No.	Applicable Cable
HRM(G)-200-040PJ4BN	CL0323-0964-0-00	φ 0.81
HRM(G)-200-066PJ4BN	CL0323-0965-0-00	φ 1.13, φ 1.32
HRM(G)-200-088PJ4BN	CL0323-0966-0-00	φ 1.37, φ 1.48

### ●Panel Jack (2 Screws Type)

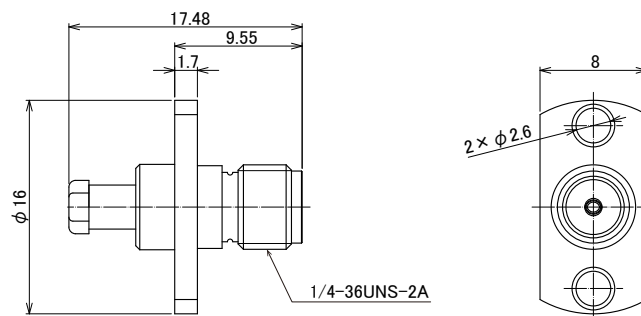

Part No.	HRS No.	Applicable Cable
HRM(G)-200-040PJ2BN	CL0323-0961-0-00	φ 0.81
HRM(G)-200-066PJ2BN	CL0323-0962-0-00	φ 1.13, φ 1.32
HRM(G)-200-088PJ2BN	CL0323-0963-0-00	φ 1.37, φ 1.48

### ●Panel Jack (Nut Type)

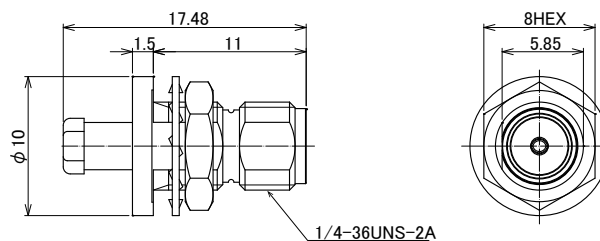

Part No.	HRS No.	Applicable Cable
HRM(G)-200-040BPJBN	CL0323-0967-0-00	φ 0.81
HRM(G)-200-066BPJBN	CL0323-0968-0-00	φ 1.13, φ 1.32
HRM(G)-200-088BPJBN	CL0323-0969-0-00	φ 1.37, φ 1.48

### Mounting Hole Dimension

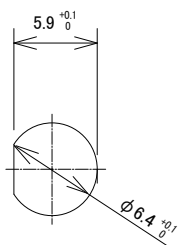



## While Taking into Consideration

Specifications mentioned in this catalog are reference values.

When considering to order or use this product, please review the Drawing and Product Specifications sheets.

Use an appropriate cable when using the connector in combination with cables.

If considering usage of a non-specified cable, please contact your sales representative.

If assembly process is done by jigs & tools which are not identified by Hirose, the warranty of the product may be affected.

If considering usage for below mentioned applications, please contact your sales representative.

In cases where the application will demand a high level of reliability, such as automotive, medical instruments, public infrastructure, aerospace/defense etc. Hirose must review before assurance of reliability can be given.

## SMA(R) Series

# 26.5GHz Compatible RP-SMA Coaxial Connector



RF



MIL Standard



Wide Variation

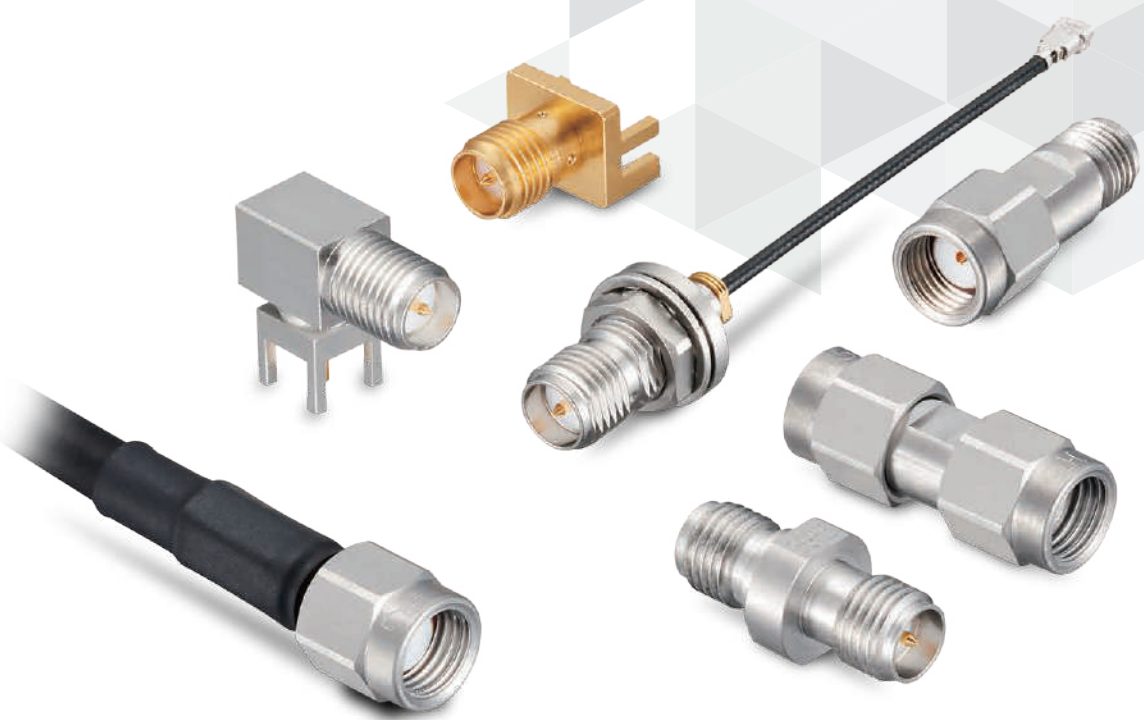

Jun. 1. 2024 Copyright 2024 HIROSE ELECTRIC CO., LTD. All Rights Reserved.



## Features

---

### 1. Excellent High Frequency Characteristics

The same performance as our company HRM Series, the first SMA connector made in Japan. Complies with FCC standard (Part 15 47 CFR 15. 203 \*).

### 2. Small, Light and Robust

### 3. Variations

Various conversion adapters such as SMA and FL are available. Compatible with cable assembly products with FL series.

## Applications

Wi-Fi devices, gaming devices, measuring device, and device-to-device connections requiring special interfaces

## Product Specifications

Nominal Characteristic Impedance	50 $\Omega$	Operating Temperature	-55 to +105°C
Rated Frequency	0 to 26.5GHz	Operating Relative Humidity	95% Max.

Items	Specifications	Conditions
Contact Resistance	<ul style="list-style-type: none"> <li>● SMA(R)-300-126B Center : 6m <math>\Omega</math> Max. External : 6m <math>\Omega</math> Max.</li> </ul>	Measured at 100mA Max.
	<ul style="list-style-type: none"> <li>● HRMJ-SMA(R)P Center : 8m <math>\Omega</math> Max. External : 8m <math>\Omega</math> Max.</li> </ul>	
Withstand Voltage	No breakdown	1000V AC for 1 min.
Insulation Resistance	5000M $\Omega$ Min.	Measured at 500V DC
Moisture Resistance	<ul style="list-style-type: none"> <li>● SMA(R)-300-126B Insulation Resistance : 100M <math>\Omega</math> Min. (in a high humidity environment) Insulation Resistance : 5000M <math>\Omega</math> Min. (in a dry environment)</li> </ul>	Left for 10 cycles (240 hours) in an environment with the temperature ranging from +25 to +65°C and the humidity ranging from 90 to 98%.
	<ul style="list-style-type: none"> <li>● HRMJ-SMA(R)P Insulation Resistance : 100M <math>\Omega</math> Min. (in a high humidity environment) Insulation Resistance : 1000M <math>\Omega</math> Min. (in a dry environment)</li> </ul>	
Temperature Cycle	No broken, cracked, or loose parts	5 cycles of the following test series condition : Temperature : -65 to +125°C Time : 30 min. → 30 min.
Salt Spray	<ul style="list-style-type: none"> <li>● SMA(R)-300-126B V.S.W.R. 1.3 Max. (including PCB) (0 to 3GHz) V.S.W.R. 1.5 Max. (including PCB) (3 to 6GHz)</li> </ul>	Left for 48 hour cycle in 5% salt water solution
	<ul style="list-style-type: none"> <li>● HRMJ-SMA(R)P V.S.W.R. 1.4 Max. (0 to 26.5GHz)</li> </ul>	
Mating Cycles	<ul style="list-style-type: none"> <li>● SMA(R)-300-126B Contact resistance Center : 8m <math>\Omega</math> Max. External : 8m <math>\Omega</math> Max.</li> </ul>	500 cycles
	<ul style="list-style-type: none"> <li>● HRMJ-SMA(R)P Contact resistance Center : 12m <math>\Omega</math> Max. External : 12m <math>\Omega</math> Max.</li> </ul>	1000 cycles
V.S.W.R.	<ul style="list-style-type: none"> <li>● SMA(R)-300-126B V.S.W.R. 1.3 Max. (including PCB) (0 to 3GHz) V.S.W.R. 1.5 Max. (including PCB) (3 to 6GHz)</li> </ul>	
	<ul style="list-style-type: none"> <li>● HRMJ-SMA(R)P V.S.W.R. 1.25 Max. (0 to 12.4GHz) V.S.W.R. 1.3 Max. (12.4 to 18GHz) V.S.W.R. 1.4 Max. (18 to 26.5GHz)</li> </ul>	

## Materials / Finish

Part	Materials	Finish
Shell (Receptacle, etc.)	Brass	Gold Plated
Shell (Plug, Shell body, etc.)	Stainless Steel	Gold Plated, Passivated
Male Center Contact	Brass	Gold Plated
Female Center Contact	Beryllium Copper	Gold Plated
Insulator	PTFE Resin	—

## Product Number Structure

Refer to the chart below when determining the product specifications from the product number.  
Please select from the product numbers listed in this catalog when placing orders.

**SMA(R) - [ ] - [ ] - [ ] - [ ]**

①
②
③
④
⑤

<b>①</b> Series Name	Plug, Receptacle : SMA(R) Adapter or Cable Assembly to HRM Connector : HRM Other Adapter, Cable Assembly : SMA(R), SMAR	<b>④</b> Cable Length Identification Code	Cable Assembly : A
<b>②</b> Connector Type	Plug, Receptacle 200 : Flexible Cable 300 : Receptacle Adapter or Cable Assembly to connect to HRM : SMA(R), SMAR Other Adapter, Cable Assembly : U.FL / BPJ	<b>⑤</b> Cable Length	Cable Assembly : 1 to 3 digits
<b>③</b> Serial Number / Cable Type	Plug, Receptacle : 1 to 3 digits Cable Assembly : 066 / 088		

## Functional Diagram

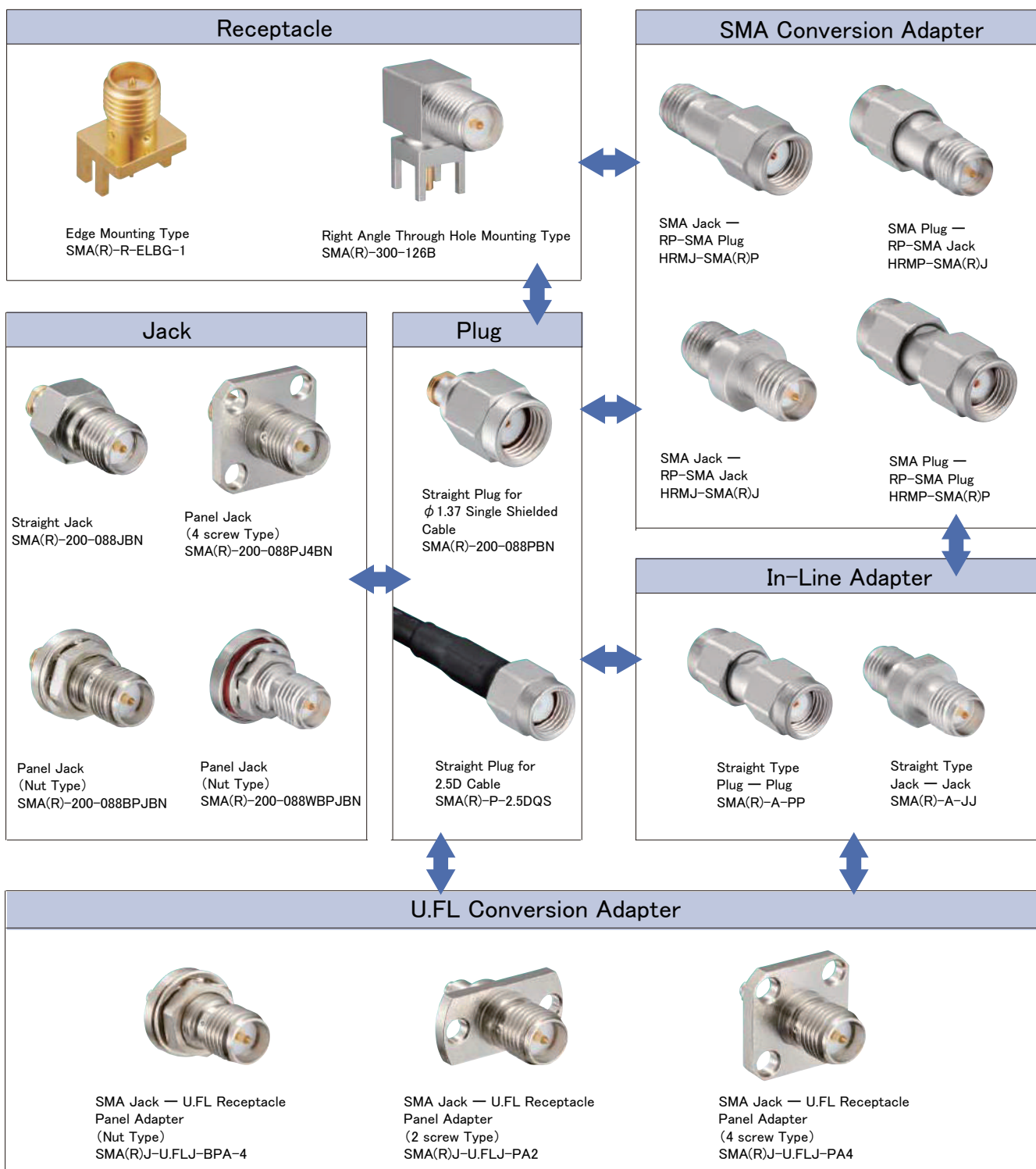

## Frequency Characteristics (Typical Example)

Straight Adapters, the combination of SMA Plug - RP-SMA Plug and SMA Jack - RP-SMA Jack

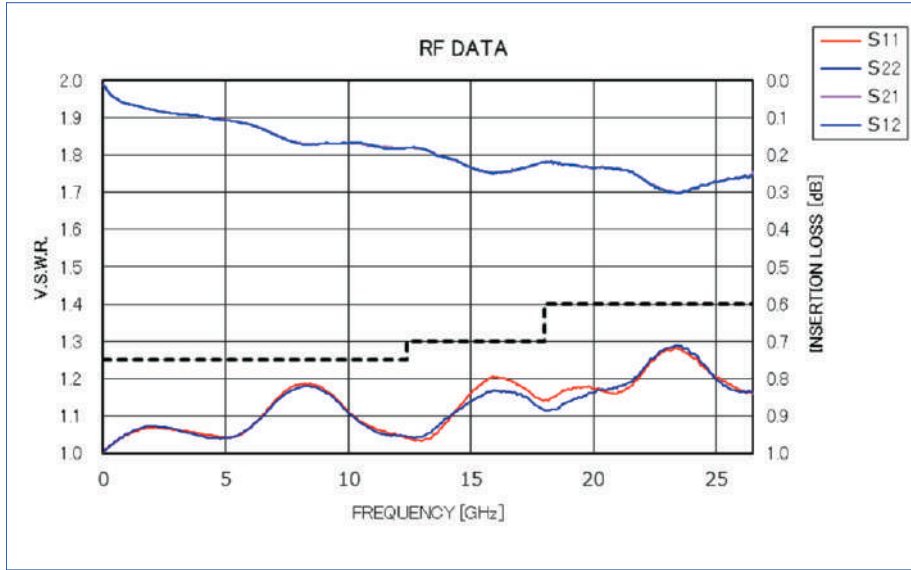
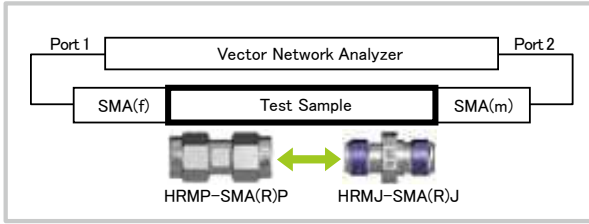

## Dimensions of Mated Portion

### Plug Joints

#### Shape 1

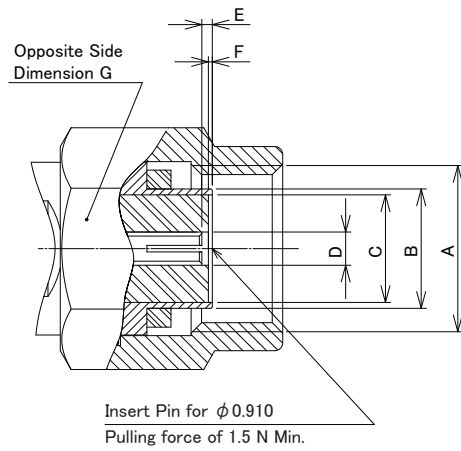

Symbol	Dimension Value
A	1/4-36UNS-2B
B	$\phi 4.56$
C	$\phi 4.11$
D	$\phi 1.27$
E	0.13
F	0.08
G	8

#### Shape 2

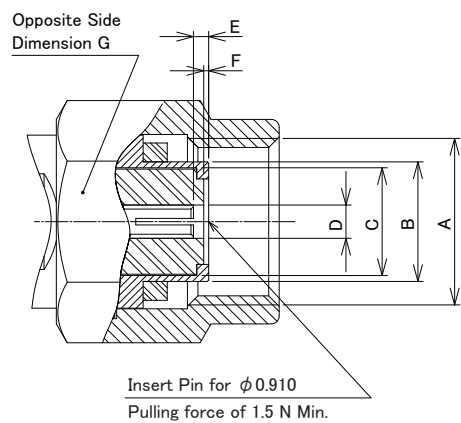

Symbol	Dimension Value
A	1/4-36UNS-2B
B	$\phi 4.56$
C	$\phi 4.11$
D	$\phi 1.27$
E	0.58
F	0.08
G	8



## Jack Joint

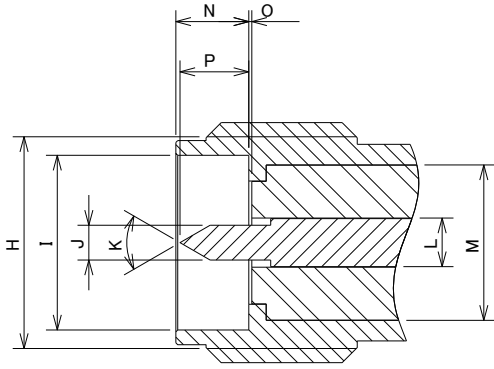

Symbol	Dimension Value
H	1/4-36UNS-2A
I	φ 4.62
J	φ 0.92
K	60°
L	φ 1.27
M	φ 4.11
N	1.93
O	0.08
P	1.8

## For Micro-Coaxial Cable (Frequency up to 8GHz)

### ● Straight Plug

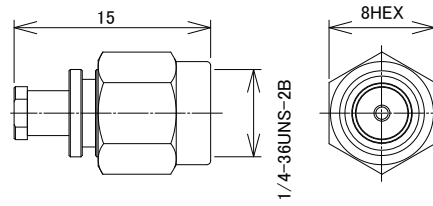

Part No.	HRS No.	Applicable Cable	Purchase Unit
SMA(R)-200-040PBN	CL0323-0925-0-00	φ 0.81	20pcs per bag
SMA(R)-200-066PBN	CL0323-0930-0-00	φ 1.13, φ 1.32	
SMA(R)-200-088PBN	CL0323-0905-3-00	φ 1.37, φ 1.48	

### ● Straight Jack

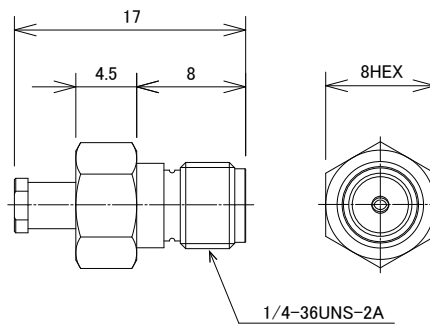

Part No.	HRS No.	Applicable Cable	Purchase Unit
SMA(R)-200-040JBN	CL0323-0926-3-00	φ 0.81	20pcs per bag
SMA(R)-200-066JBN	CL0323-0931-3-00	φ 1.13, φ 1.32	
SMA(R)-200-088JBN	CL0323-0904-0-00	φ 1.37, φ 1.48	

●Panel Jack  
(4 screw Type)

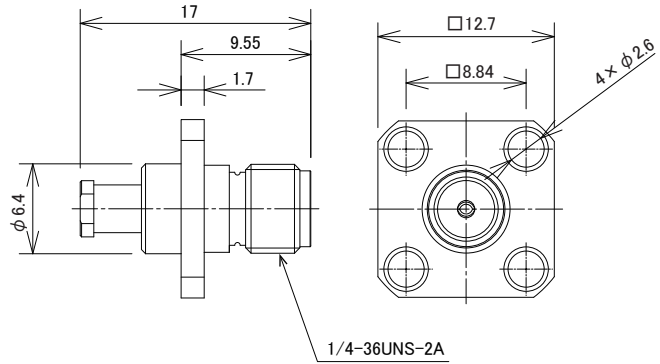

Part No.	HRS No.	Applicable Cable	Purchase Unit
SMA(R)-200-040PJ4BN	CL0323-0928-9-00	φ 0.81	20pcs per bag
SMA(R)-200-066PJ4BN	CL0323-0932-6-00	φ 1.13, φ 1.32	
SMA(R)-200-088PJ4BN	CL0323-0934-1-00	φ 1.37, φ 1.48	

●Panel Jack  
(2 screw Type)

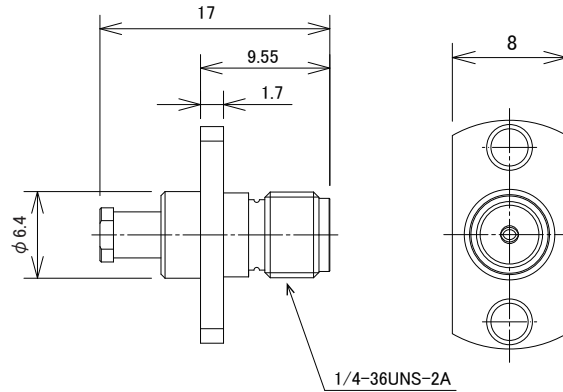

Part No.	HRS No.	Applicable Cable	Purchase Unit
SMA(R)-200-040PJ2BN	CL0323-0929-1-00	φ 0.81	20pcs per bag
SMA(R)-200-066PJ2BN	CL0323-0933-9-00	φ 1.13, φ 1.32	
SMA(R)-200-088PJ2BN	CL0323-0935-4-00	φ 1.37, φ 1.48	

### ●Panel Jack (Nut Type)

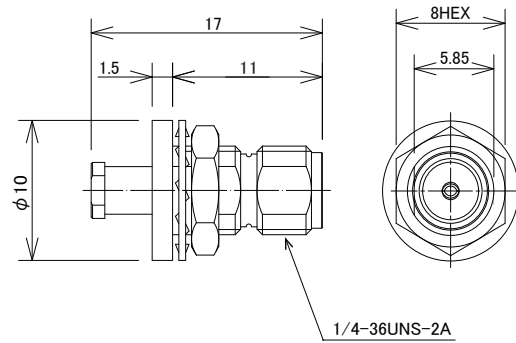

Part No.	HRS No.	Applicable Cable	Purchase Unit
SMA(R)-200-040BPJBN	CL0323-0927-6-00	$\phi$ 0.81	20pcs per bag
SMA(R)-200-066BPJBN	CL0323-0902-5-00	$\phi$ 1.13, $\phi$ 1.32	
SMA(R)-200-088BPJBN	CL0323-0901-2-00	$\phi$ 1.37, $\phi$ 1.48	

### Panel Cut-Out Dimensions

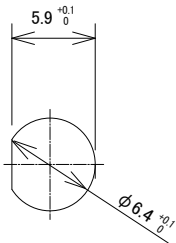

### ●Panel Jack (Nut Type, Flange Part Waterproof)

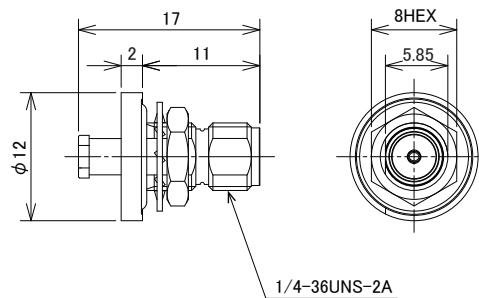

Part No.	HRS No.	Applicable Cable	Purchase Unit
SMA(R)-200-040WBPJBN	CL0323-0947-3-00	$\phi$ 0.81	20pcs per bag
SMA(R)-200-066WBPJBN	CL0323-0948-6-00	$\phi$ 1.13, $\phi$ 1.32	
SMA(R)-200-088WBPJBN	CL0323-0949-9-00	$\phi$ 1.37, $\phi$ 1.48	

### Panel Cut-Out Dimensions

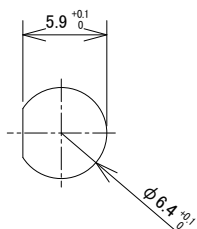

## Straight Plug (Frequency up to 6GHz)

● For Flexible Cables

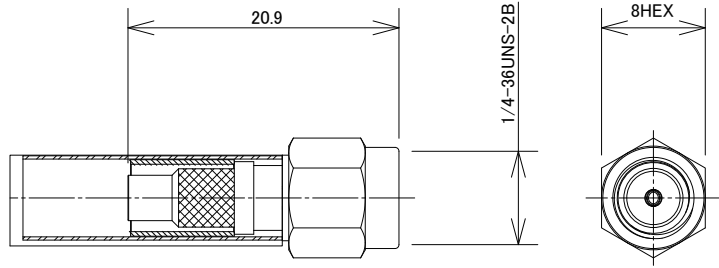

Part No.	HRS No.	Applicable Cable	Purchase Unit
SMA(R)-P-2.5DQS	CL0323-0875-4-00	2.5D-HQ SUPER	20pcs per bag

## Receptacle (Frequency up to 6GHz)

### ● Right Angle Receptacle (PCB Mounting Type)

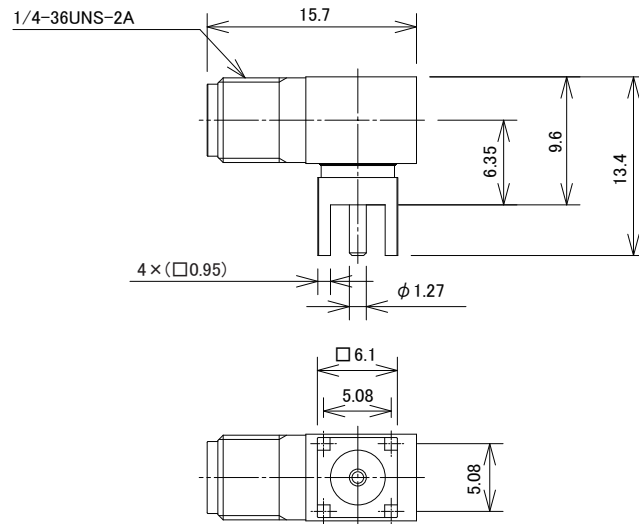
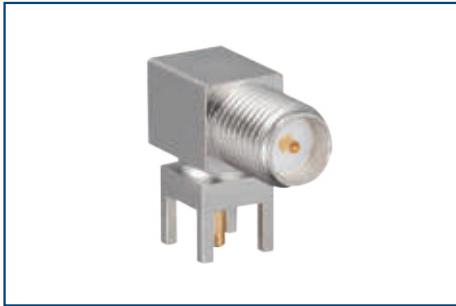

Part No.	HRS No.	Remarks	Purchase Unit
SMA(R)-300-126B	CL0323-0111-0-00	Shell : Brass	20pcs per bag

### ● PCB Clip Type (Frequency up to 3GHz)

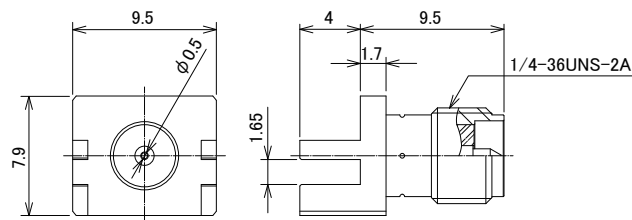

Part No.	HRS No.	Remarks	Purchase Unit
SMA(R)-R-ELBG-1	CL0323-0866-3-00	PCB Thickness : 1.6mm	20pcs per bag

## In-Line Adapter

### ● Jack - Jack

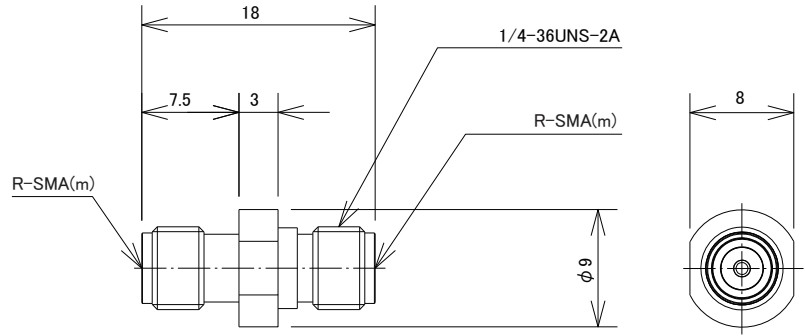

Part No.	HRS No.	Remarks	Purchase Unit
SMA(R)-A-JJ	CL0323-0124-0-00	Shell : Stainless Steel	20pcs per bag

### ● Plug - Plug

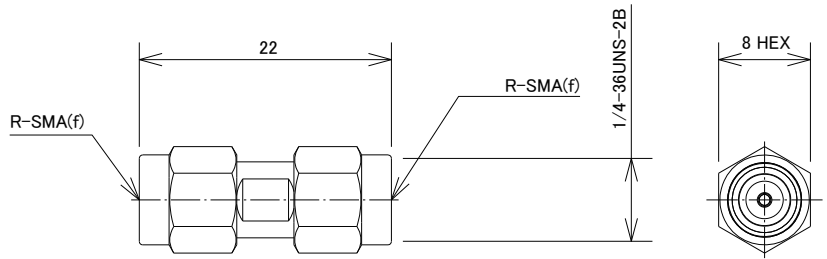

Part No.	HRS No.	Remarks	Purchase Unit
SMA(R)-A-PP	CL0323-0127-0-00	Shell : Stainless Steel	20pcs per bag

## Conversion Adapter

### ● SMA Conversion Adapter (SMA Jack - RP-SMA Plug)

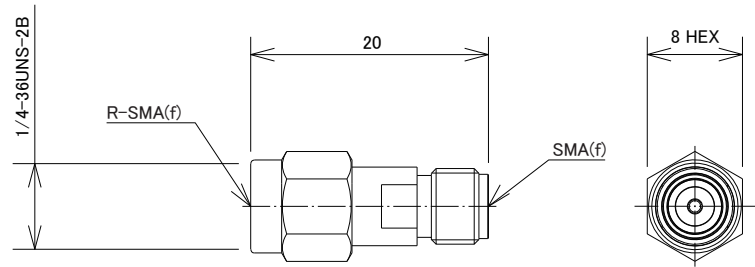

Part No.	HRS No.	Remarks	Purchase Unit
HRMJ-SMA(R)P	CL0323-0035-0-00	Shell : Stainless Steel	20pcs per bag

### ● SMA Conversion Adapter (SMA Plug - RP-SMA Jack)

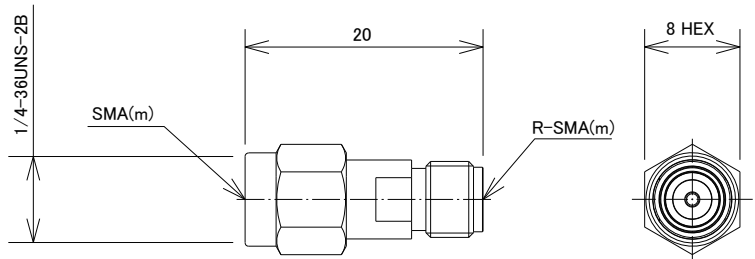

Part No.	HRS No.	Remarks	Purchase Unit
HRMP-SMA(R)J	CL0323-0036-0-00	Shell : Stainless Steel	20pcs per bag



● SMA Conversion Adapter  
(SMA Jack - RP-SMA Jack)

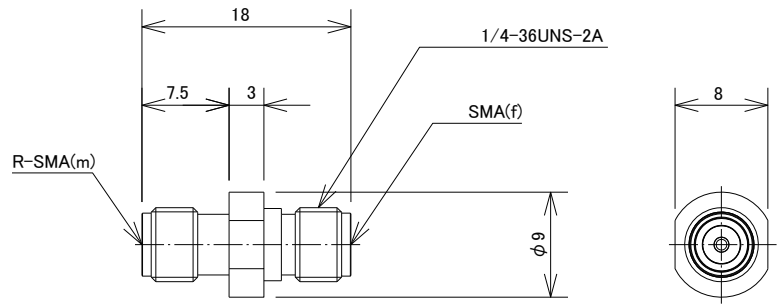

Part No.	HRS No.	Remarks	Purchase Unit
HRMJ-SMA(R)J	CL0323-0011-0-00	Shell : Stainless Steel	20pcs per bag

● SMA Conversion Adapter  
(SMA Plug - RP-SMA Plug)

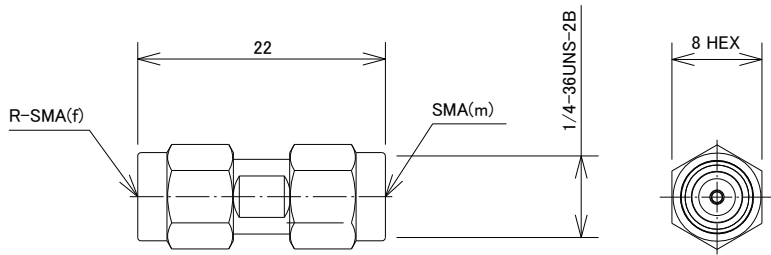

Part No.	HRS No.	Remarks	Purchase Unit
HRMP-SMA(R)P	CL0323-0009-0-00	Shell : Stainless Steel	20pcs per bag

## U.FL-R Conversion Adapter (Frequency up to 8GHz)

### ● Panel Adapter (4 Screw Type)

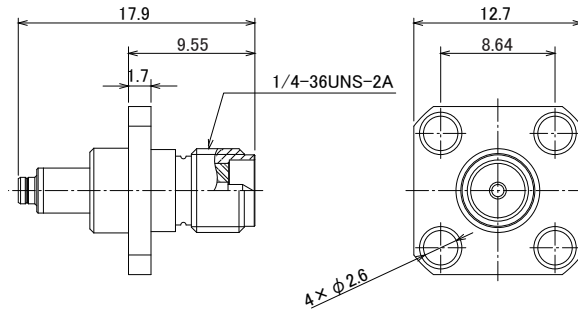

Part No.	HRS No.	Remarks	Purchase Unit
SMA(R)J-U.FLJ-PA4	CL0311-0466-5-00	Shell : Brass	20pcs per bag

### ● Panel Adapter (2 Screw Type)

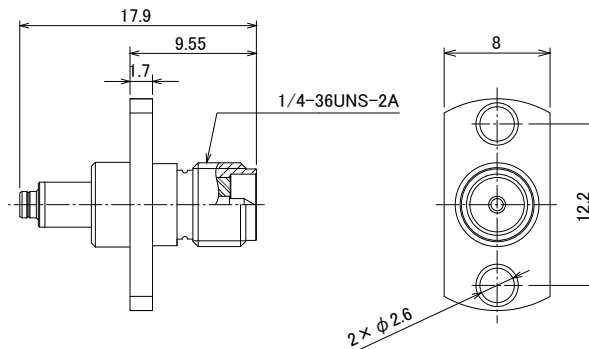

Part No.	HRS No.	Remarks	Purchase Unit
SMA(R)J-U.FLJ-PA2	CL0311-0468-0-00	Shell : Brass	20pcs per bag

### ● Panel Adapter (Nut Type)

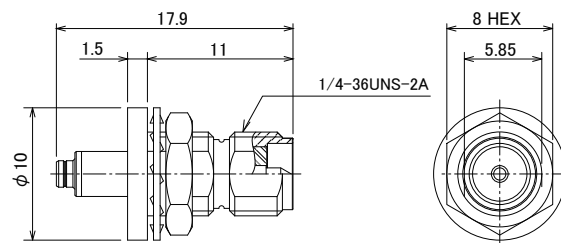

Part No.	HRS No.	Remarks	Purchase Unit
SMA(R)J-U.FLJ-BPA-4	CL0311-0464-0-00	Shell : Brass	20pcs per bag

### Panel Cut-Out Dimensions

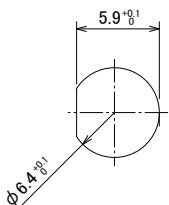

## Termination Tools

Type	Part No.	Termination Tools	HRS No.	Overview
Straight Plug (Common to Termination Tools)	SMA(R)-200-040PBN(40)	HRM-200/SO-MD	CL0902-3192-6-00	External Solder Receiver
	SMA(R)-200-066PBN(40)	HRM-200/SO-MD2	CL0902-3199-5-00	Center Solder Receiver
	SMA(R)-200-088PBN(40)	HRM-200-PBN/CV-MD	CL0902-3198-2-00	Cord Tube Press-fit
Straight Jack (Common to Termination Tools)	SMA(R)-200-040JBN(40)	HRM-200/SO-MD	CL0902-3192-6-00	External Solder Receiver
	SMA(R)-200-066JBN(40)	HRM-200/SO-MD2	CL0902-3199-5-00	Center Solder Receiver
	SMA(R)-200-088JBN(40)	HRM-200-JBN/CV-MD	CL0902-3195-4-00	Cord Tube Press-fit
Panel Jack, 4 Screw Type (Common to Termination Tools)	SMA(R)-200-040PJ4BN(40)	HRM-200/SO-MD	CL0902-3192-6-00	External Solder Receiver
	SMA(R)-200-066PJ4BN(40)	HRM-200/SO-MD2	CL0902-3199-5-00	Center Solder Receiver
	SMA(R)-200-088PJ4BN(40)	HRM-200-PJ4BN/CV-MD	CL0902-3197-0-00	Cord Tube Press-fit
Panel Jack, 2 Screw Type (Common to Termination Tools)	SMA(R)-200-040PJ2BN(40)	HRM-200/SO-MD	CL0902-3192-6-00	External Solder Receiver
	SMA(R)-200-066PJ2BN(40)	HRM-200/SO-MD2	CL0902-3199-5-00	Center Solder Receiver
	SMA(R)-200-088PJ2BN(40)	HRM-200-PJ2BN/CV-MD	CL0902-3196-7-00	Cord Tube Press-fit
Panel Jack, Nut Type (Common to Termination Tools)	SMA(R)-200-040BPJBN(40)	HRM-200/SO-MD	CL0902-3192-6-00	External Solder Receiver
	SMA(R)-200-066BPJBN(40)	HRM-200/SO-MD2	CL0902-3199-5-00	Center Solder Receiver
	SMA(R)-200-088BPJBN(40)	HRM-200-BP2BN/CV-MD	CL0902-3194-1-00	Cord Tube Press-fit
Panel Jack, Waterproof Nut Type (Common to Termination Tools)	SMA(R)-200-040WBPJBN	HRM-200/SO-MD	CL0902-3192-6-00	External Solder Receiver
	SMA(R)-200-066WBPJBN	HRM-200/SO-MD2	CL0902-3199-5-00	Center Solder Receiver
	SMA(R)-200-088WBPJBN	HRM-200-BP2BN/CV-MD	CL0902-3194-1-00	Cord Tube Press-fit

## While Taking into Consideration

Specifications mentioned in this catalog are reference values.

When considering to order or use this product, please review the Drawing and Product Specifications sheets.

Use an appropriate cable when using the connector in combination with cables.

If considering usage of a non-specified cable, please contact your sales representative.

If assembly process is done by jigs & tools which are not identified by Hirose, the warranty of the product may be affected.

If considering usage for below mentioned applications, please contact your sales representative.

In cases where the application will demand a high level of reliability, such as automotive, medical instruments, public infrastructure, aerospace/defense etc. Hirose must review before assurance of reliability can be given.

**HIROSE****HIROSE ELECTRIC CO.,LTD.**2-6-3 Nakagawa Chuoh, Tsuzuki-Ku, Yokohama-Shi 224-8540, JAPAN  
<https://www.hirose.com>