

GT36S Series

Compact Board Connector for Coaxial Line



Space Saving



User Friendly



3 GHz

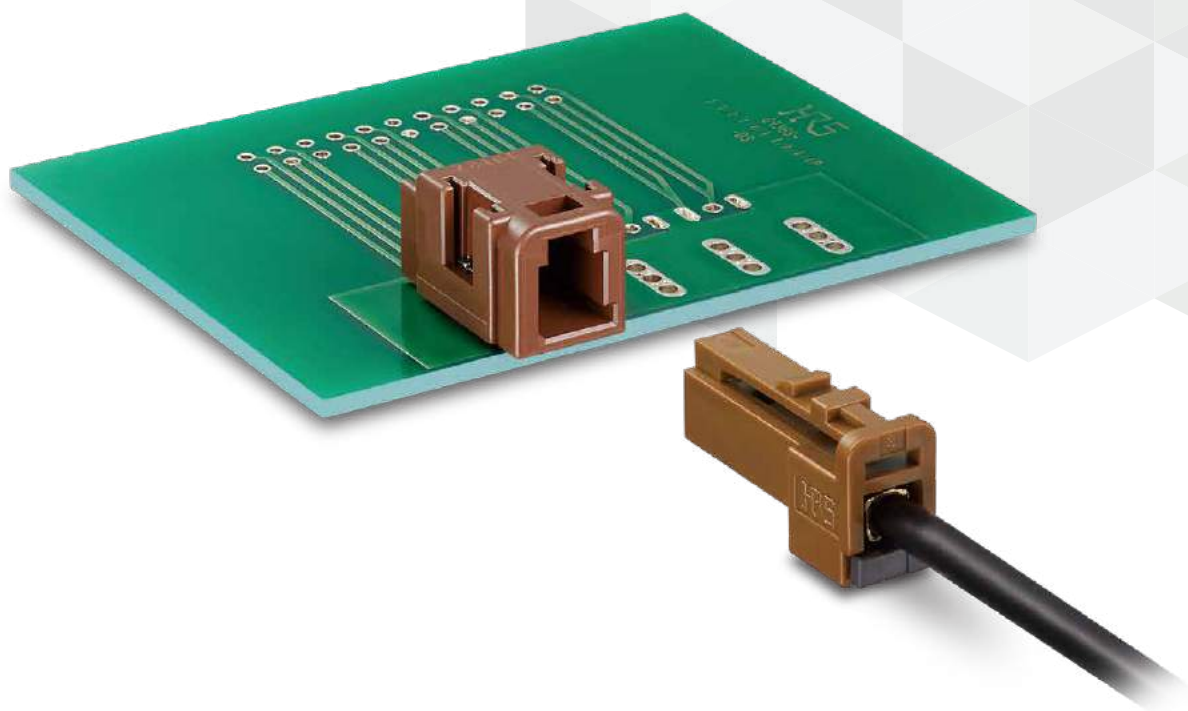

Features

1. Allows crimping of the center conductor and outer conductor in one step

Cable assembly can be completed without touching the center conductor. The positioning accuracy of the center conductor can be maintained regardless of the operator's skill level, contributing to stable cable assembly quality. Additionally, completing crimping of the center and outer conductor in one step reduces harnessing time.

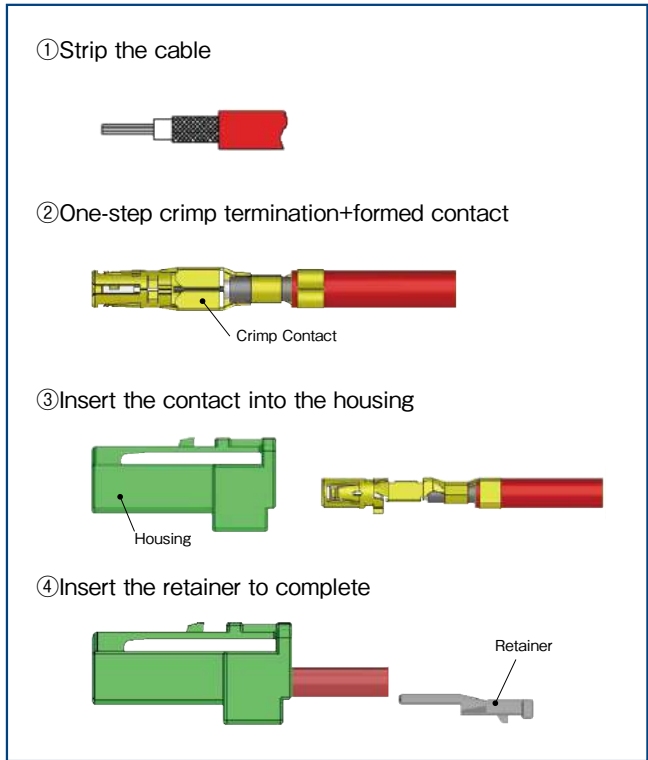

One-step Termination for Quality Consistency and Reduced Labor Hours

2. Space-saving Design

3. Excellent High Frequency Characteristics

V.S.W.R.
DC to 3.0GHz : 1.5 Max.

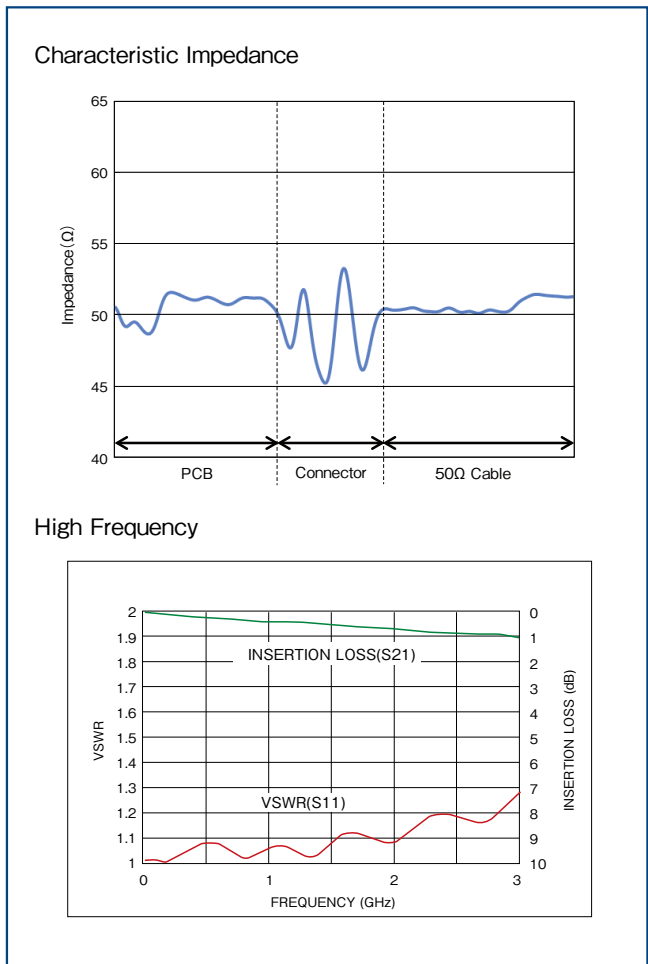

4. Four types of mating keys from A to D are available

Prevents incorrect mating even during blind mating

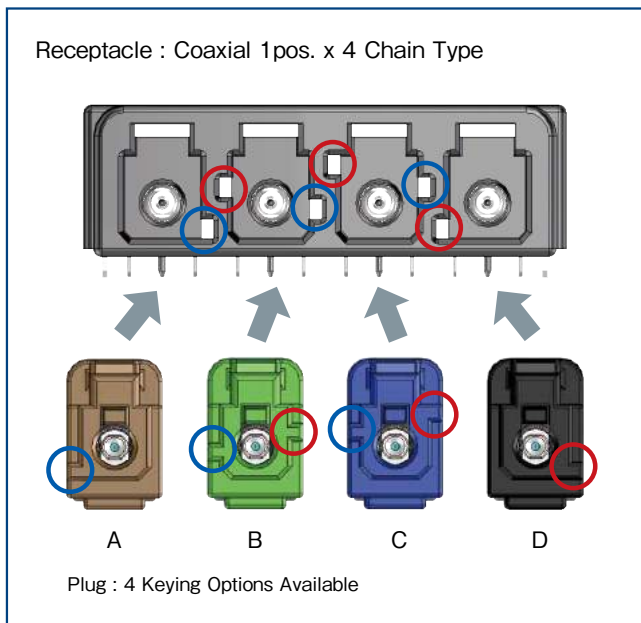

Applications

Digital terrestrial TV, radio, automobile sensors (temperature, pressure, etc.), VICS, GPS, Bluetooth, TEL, satellite radio, etc.

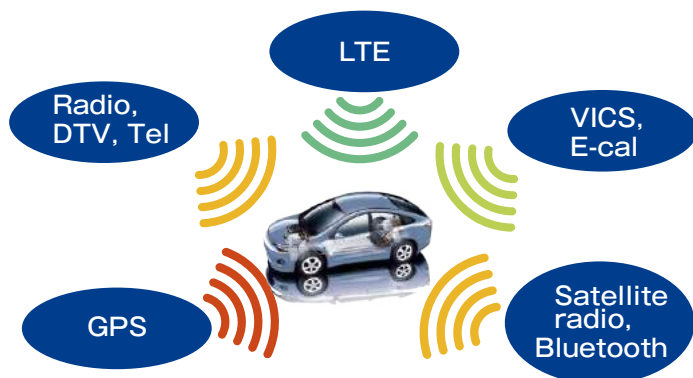

Product Specifications

Rated Current	1A	Operating Temperature (Note 1)	-40 to +105°C
Rated Voltage	50V DC		

Items	Specifications	Conditions
Contact Resistance	50m Ω Max.	Measured at 1A DC
Insulation Resistance	100M Ω Min.	Measured at 500V DC
Withstanding Voltage	There shall be no dielectric breakdown.	Voltage of 500V AC for 1 min.
Mating Durability	Contact Resistance : 100m Ω Max.	30 Insertion/Extraction cycles
Vibration Resistance	No electrical discontinuity of 10 μ s or more. Contact Resistance : 100m Ω Max. No Damage, Cracks or Distortion of Parts	Frequency : 20 to 200Hz, Constant Acceleration of 43.1m/s ² , 3 hours in 3 directions
Thermal Shock	Contact Resistance : 100m Ω Max. No Damage, Cracks or Distortion of Parts	Temperature : -40 → +5 to +35 → +85 → +5 to +35°C Time : 30 → 5 → 30 → 5 minutes for 1000 cycles
Heat Resistance	Contact Resistance : 100m Ω Max. No Damage, Cracks or Distortion of Parts	Left at 105°C for 300 hours
Cold Resistance	Contact Resistance : 100m Ω Max. No Damage, Cracks or Distortion of Parts	Left at -40°C for 120 hours
Humidity Resistance	Contact Resistance : 100m Ω Max. Insulation Resistance : 100M Ω Min. No Damage, Cracks or Distortion of Parts	Left for 500 hours at a temperature of 60°C and a relative humidity 90 to 95%

Note 1 : Includes temperature rise caused by current flow.

Note 2 : The contact resistance of the outer conductor after environment/durability testing is 150 m Ω or less.

Material/Finish

Component	Part	Material	Color / Finish	UL Standard
Receptacle	Central Terminal	Brass	Tin Plated	-
	Housing	PA	Natural	UL94V-0
	Outer Conductor Terminal	Brass	Tin Plated	-
	Housing	PA	Brown, Green, Blue, Black	UL94V-0
	Retention Tab	Brass	Tin Plated	-
Plug	Housing	PBT	Brown, Green, Blue, Black, Light Gray	UL94HB
Plug Retainer	Retainer	PBT	Dark Gray	UL94HB
Coaxial Terminal for Plugs	Central Terminal	Phosphor bronze	Tin Plated	-
	Housing	PA	Black	UL94V-0
	Outer Conductor Terminal	Brass	Tin Plated	-

Product Number Structure

Refer to the chart below when determining the product specifications from the product number.
Please select from the product numbers listed in this catalog when placing orders.

● Receptacle

GT36S - 1 P - DS (A)

① ② ③ ④ ⑤

① Series Name	GT36S	④ Terminal Shape	Right Angle THT Type
② Number of Connections	1 : 1 station 1 / 1 / 1 / 1 : 1 pos. x 4 chains	⑤ Mating Key	A, B, C, D : 1 type each ABCD : 4 types of A, B, C, D
③ Connector Type	P : Receptacle		

● Plug / Retainer

GT36S - 1 S - HU (A)

① ② ③ ④ ⑤

① Series Name	GT36S	④ Part type	HU : Housing R : Retainer
② No. of Pos.	1	⑤ Mating Key	A, B, C, D, M (Note)
③ Connector Type	S : Plug		

Note : GT36S-1S-HU (M) is a master key type without a mating key.

● Plug Coaxial Terminal

GT36S - 2426 / 1.6 - 2.9 SCF

① ② ③ ④ ⑤

① Series Name	GT36S	④ Applicable Wire : Jacket Outer Diameter	Approximately ϕ 2.9mm
② Applicable Wire : Core Wire Size	24-26 AWG	⑤ Form Type / Packing Type	Socket contacts, reels
③ Applicable Wire : Insulation Outer Diameter	Approximately ϕ 1.6mm		

Receptacle

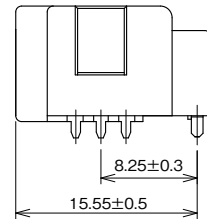
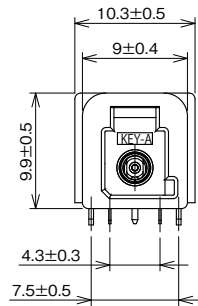
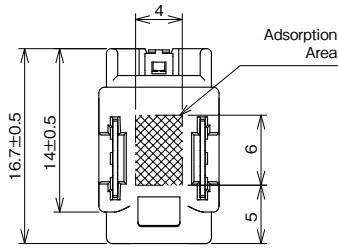

- Recommended PCB Layout
(Board thickness : 1.6 mm, Metal Mask Thickness : 0.15mm)

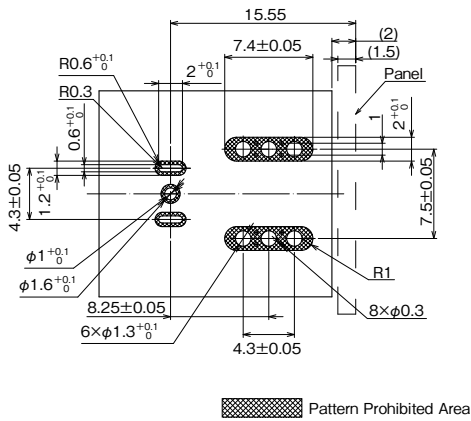

● Panel Mounting Dimensions

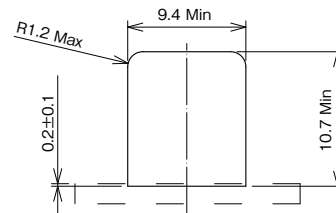

Part No.	HRS No.	Mating Key	Color	Purchase Unit
GT36S-1P-DS(A)	CL0786-0046-0-00	A Key	Brown	70pcs per tray
GT36S-1P-DS(B)	CL0786-0047-0-00	B Key	Green	
GT36S-1P-DS(C)	CL0786-0048-0-00	C Key	Blue	
GT36S-1P-DS(D)	CL0786-0049-0-00	D Key	Black	

Coaxial 1pos. x 4 Chain Type

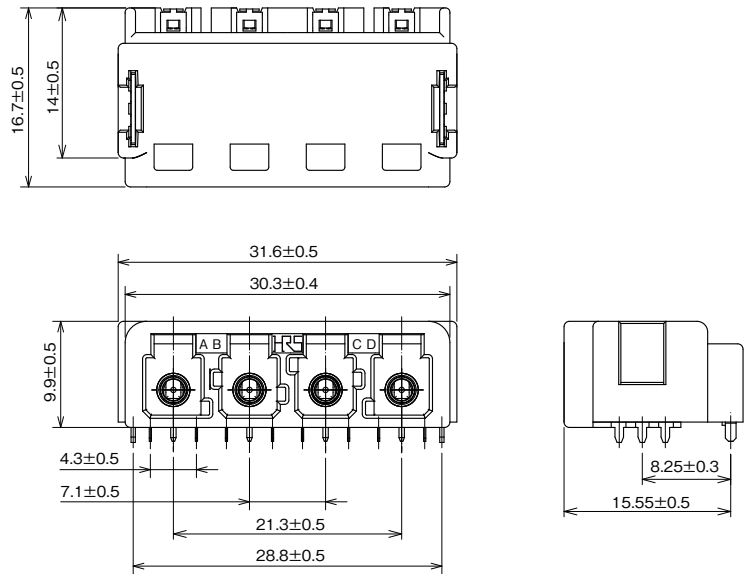

● Recommended PCB Layout

(Board thickness : 1.6 mm, Metal Mask Thickness : 0.15mm)

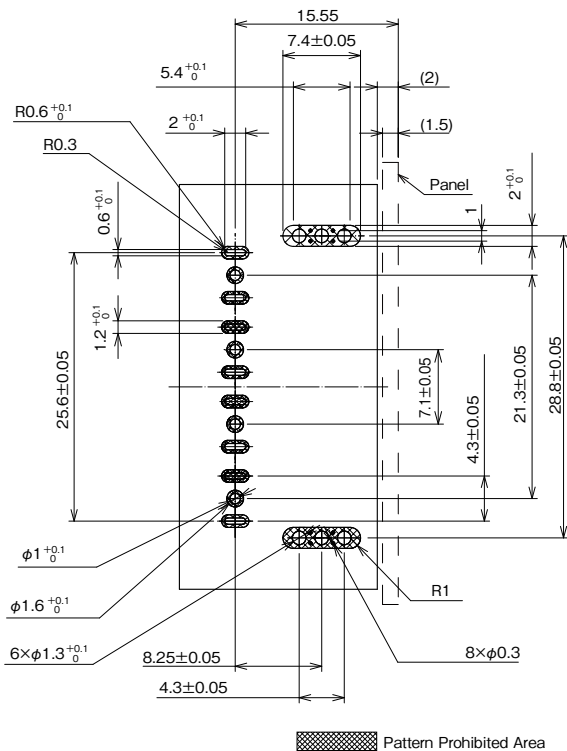

● Panel Mounting Dimensions

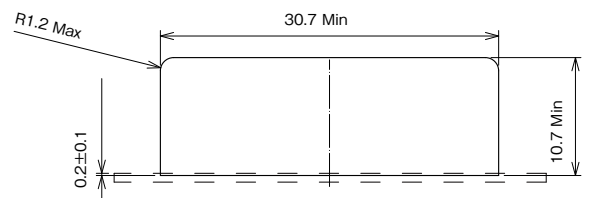

Part No.	HRS No.	Mating Key	Color	Purchase Unit
GT36S-1/1P-DS(AB)	Under Planning (Note)	2 Key Types : A and B	Black	-
GT36S-1/1/1P-DS(ABC)	Under Planning (Note)	3 Key Types : A, B and C		-
GT36S-1/1/1/1P-DS(ABCD)	CL0786-0090-0-00	4 Key Types : A, B, C and D		40pcs per tray

Note : Products without HRS No. are currently being planned for development. Please contact a Hirose representative regarding questions on pin count variation development.

Plug

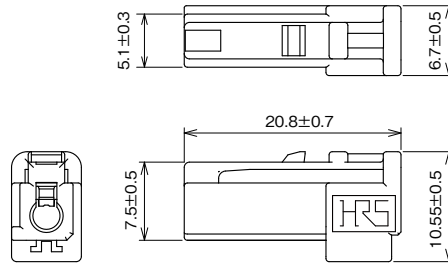
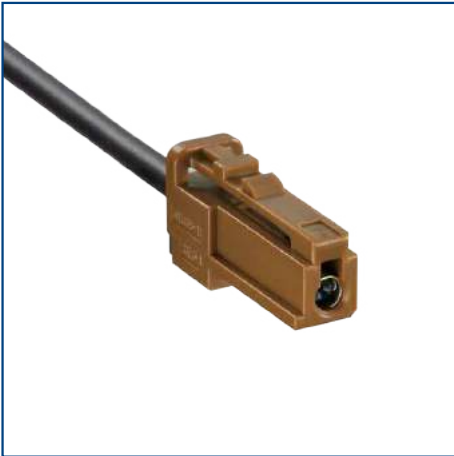

Shown with coaxial terminal inserted.

Part No.	HRS No.	Mating Key	Color	Purchase Unit
GT36S-1S-HU(A)	CL0786-0050-0-00	A Key	Brown	100pcs per bag
GT36S-1S-HU(B)	CL0786-0051-0-00	B Key	Green	
GT36S-1S-HU(C)	CL0786-0052-0-00	C Key	Blue	
GT36S-1S-HU(D)	CL0786-0086-0-00	D Key	Black	
GT36S-1S-HU(M) (Note)	CL0786-0093-0-00	M Key	Light Gray	

Note : GT36S-1S-HU(M) is a master key type without mating key.

Plug Retainer

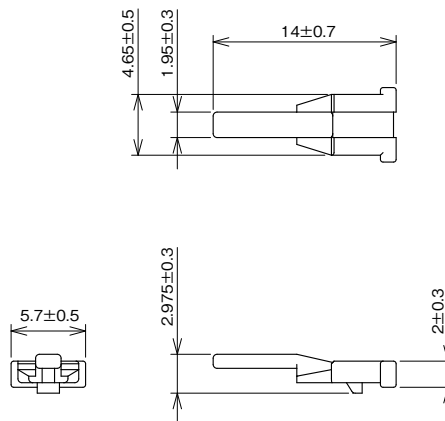

Part No.	HRS No.	Color	Purchase Unit
GT36S-1S-R	CL0786-0087-0-00	Dark Gray	100pcs per bag

Plug Coaxial Terminal

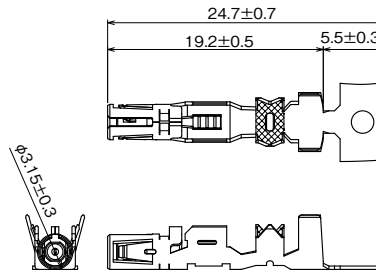

Part No.	HRS No.	Compatible Wire	Purchase Unit
GT36S-2426/1.6-2.9SCF	CL0786-0081-6-00	Core Wire Size : 24-26 AWG equivalent Insulator Outer Diameter : ϕ 1.5-2.0 Jacket Outer Diameter : ϕ 2.6-3.4	2,500pcs per reel

Mated Diagram

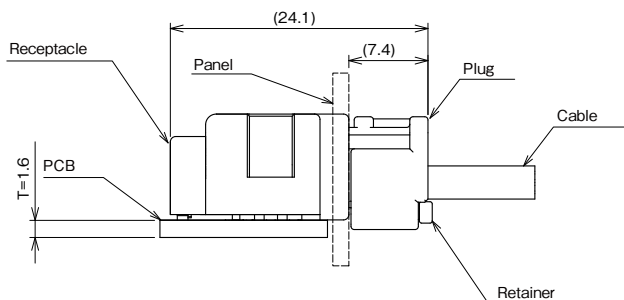

Applicable Crimping Tool

Type	Part No.	HRS No.	Compatible Terminal
Crimping Machine Body	CM-105C	CL0901-0001-0-00	-
Applicator	AP-GT36S-2426/1629S	CL0901-5233-0-00	GT36S-2426/1.6-2.9SCF
Terminal Stamping Tool	GT36S-1629S/FO-AD	CL0902-5139-0-00	GT36S-2426/1.6-2.9SCF

Note 1 : Conduct crimping based on the "Crimping Standards" and "Crimping Conditions Table".

Note 2 : Problems with tools not specified by Hirose are outside the scope of warranty.

Usage Precautions

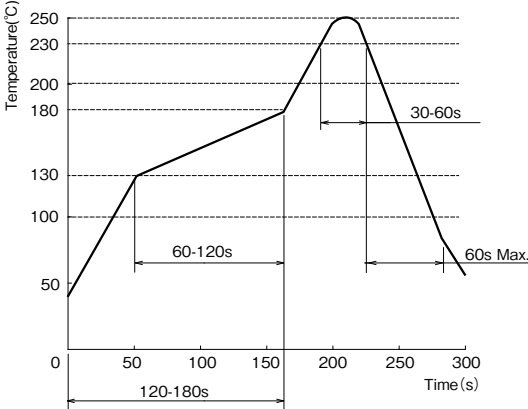
<p>Recommended Temperature Profile</p>	 <p>【Conditions】</p> <ol style="list-style-type: none"> 1. Peak Temperature 250°C Peak 2. Heated part 230°C Min. 30-60s 3. Preheat Temperature 130 to 180°C, 60-120 sec. 4. Cycles 2 times Max.
<p>Recommended Manual Soldering Conditions</p>	<p>Soldering Iron Temperature : 280 to 300°C , Soldering Time : Within 2 Seconds</p>
<p>Precautions</p>	<ol style="list-style-type: none"> 1. Excessive pull force during unmating may damage the connector. If it is difficult to remove, push in lightly once and then release the lock. 2. Always make sure to turn off the power before reinserting the connector. 3. Do not directly contact the terminal when electricity is flowing since it is extremely dangerous. 4. Contact a Hirose representative for harness procedures or handling manuals.

While Taking into Consideration

Specifications mentioned in this catalog are reference values.

When considering to order or use this product, please confirm the Drawing and Product Specifications sheets.

Use an appropriate cable when using the connector in combination with cables.

If considering usage of a non-specified cable, please contact your sales representative.

If assembly process is done by jigs & tools which are not identified by Hirose, assurance will not be given.

If considering usage for below mentioned applications, please contact your sales representative.

In cases where the application will demand a high level of reliability, such as automotive, medical instruments, public infrastructure, aerospace/ defense etc. Hirose must review before assurance of reliability can be given.