

HR41A Series

Waterproof Connectors for Outdoor Use



Harsh Environment



Waterproof



Bayonet



Jun. 1. 2024 Copyright 2024 HIROSE ELECTRIC CO., LTD. All Rights Reserved.



Features

1. Waterproof Connector with Excellent Weather Resistance for Outdoor Use

With a highly weather resistant plastic shell, HR41A is ideal for outdoor applications.

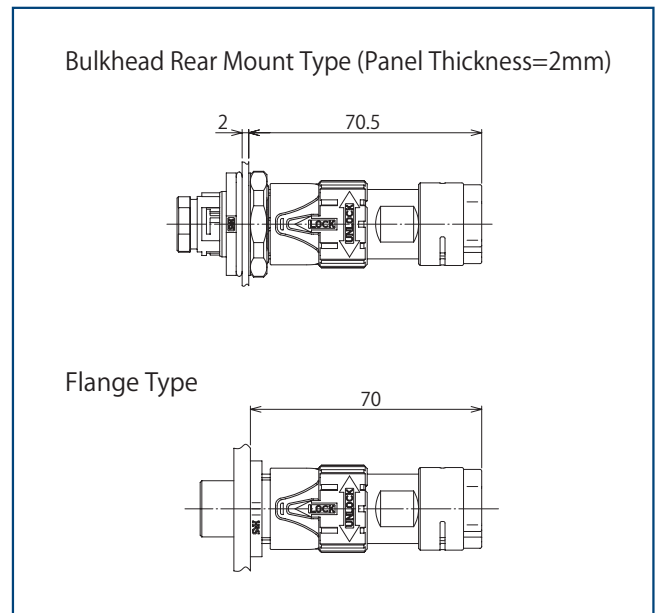

Mated Condition

2. Waterproof Performance

IP67, IP68 when mated.

IP67 : Left for 30 min. at a water depth of 1m.

IP68 : Left for 14 days at a water depth of 2m.

3. Easy to Operate Push-on Bayonet Lock

The push-on bayonet lock quickly achieves complete locking in a single action.

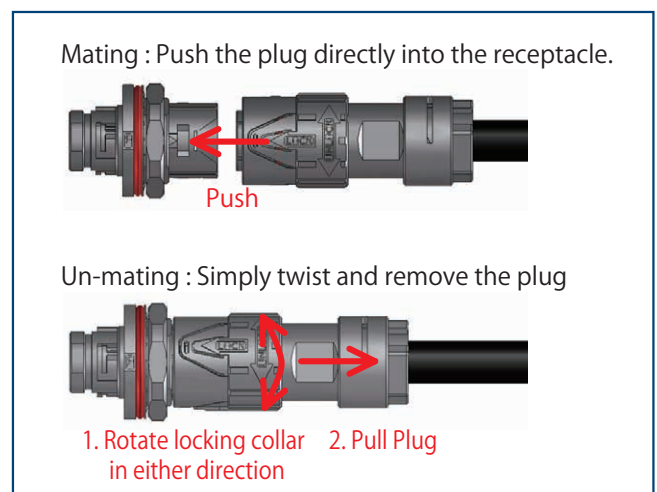

Locking Design (Push-on Bayonet Lock)

4. Easy Field Assembly

The simple crimp connection and easy assembly design are ideal for on-site assembly.

5. Sequential Contacts

Contacts are sequentially arranged.

6. Designed to Accommodate Hot Swapping

Hot swapping condition test methods meet UL1977 standards.

7. Surge Resistant

Walls between adjacent contacts provides insulation against 15kV surges caused by lightning.

Product Specifications

Rated Current (Note 1)	13A (Ambient Temp. 25°C)	Operating Temperature (Note 2)	-40 to +105°C
		Storage Temperature Range	-10 to +60°C
Rated Voltage	1000V AC/DC		

Items	Specifications	Conditions
Contact Resistance	5m Ω Max.	Measured at 1A DC
Insulation Resistance	5000M Ω Min.	Measured at 500V DC
Withstand Voltage	No flashover or breakdown	2200V AC for one min.
Vibration Resistance	No electrical interruption of 10 μ s or more	Frequency : 10 to 55 to 10Hz/cycle Half amplitude 0.75mm, 5 minutes/cycle 10 cycles each in 3 axis directions
Shock Resistance	No electrical interruption of 10 μ s or more	Acceleration : 490m/s ² , duration : 11ms, 3 times each in 3 axis directions
Mating Durability	Contact resistance 10m Ω Max.	500 times
Temperature Cycle	Insulation resistance 500M Ω Min.	-40°C for 30 minutes → Room temperature for 2 to 3 minutes → +105°C for 30 minutes → Room temperature for 2 to 3 minutes. Repeated for 5 cycles.
Moisture Resistance (Steady State)	Insulation Resistance : 50M Ω Min. (High Humidity) 500M Ω Min. (Dry)	Temperature : 40°C , relative humidity : 90 to 95%, left for 96 hours
Water Resistance	No water intrusion inside connector	Left submerged at a water depth of 2m in the mated condition for 14 days

Note 1 : Varies depending on the temperature the connector is used at. Use within the derating curve is recommended.

Note 2 : Includes temperature rise due to current flow.

Note 3 : Depending on the cable design and specifications, cable clamping force, rotation force, waterproof performance, etc. may differ. Please confirm before use.

[Reference] Derating Curve

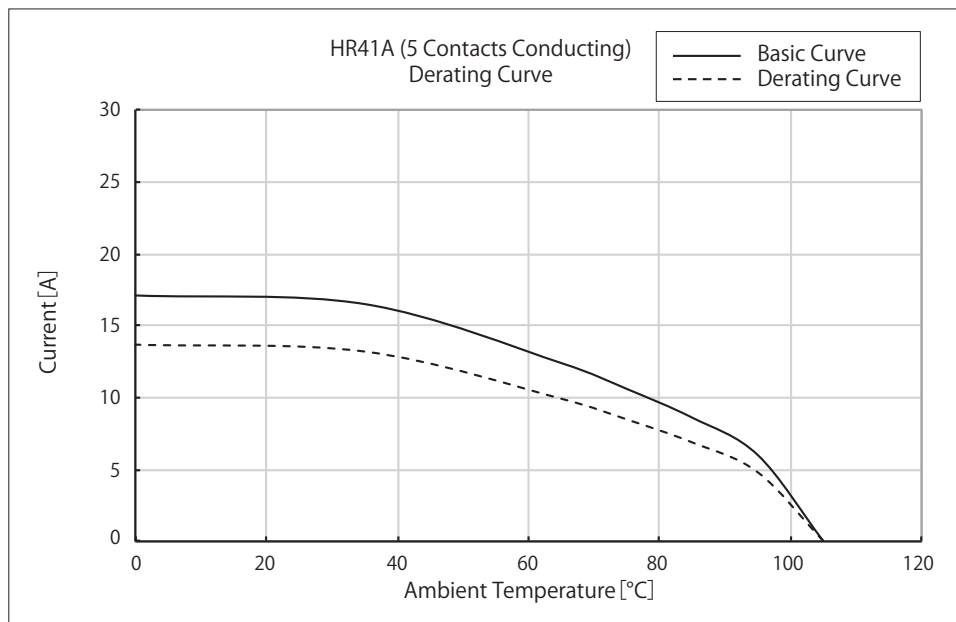

Note 1 : The derating curve is derived from the basic curve multiplied by the derating factor of 0.8.

Note 2 : The measurement method of the derating curve is as follows:

- HR41A, unused prior to testing.
- Conductor cross-sectional area of test cable : 16 AWG (1.31mm²)
- Test condition : Measured after power supplied while the mated connectors are in a stationary state.

Materials / Finish

Component	Materials	Finish
Insulator	Polyamide, PBT	-
Contact	Copper Alloy	Partially Gold Plated
O-ring, Gasket	Silicone Rubber	-

Product Number Structure

Refer to the chart below when determining the product specifications from the product number.
Please select from the product numbers listed in this catalog when placing orders.

■ Connector

HR41A - 17 W B P A - 5 S C (##)

① ② ③ ④ ⑤ ⑥ ⑦ ⑧ ⑨ ⑩

■ Crimp Contact

HR41A - S C - 1 1 1 (##)

① ⑧ ⑨ ⑪ ⑫ ⑬ ⑩

① Series Name	HR41A	⑦ No. of Pos.	3 or 5
② Shell Size	17	⑧ Contact Gender	S : Female Contact P : Male Contact
③ Specialty	W : Waterproof Type	⑨ Contact Assembly	C : Crimp
④ Lock Mechanism	B : Bayonet Lock	⑩	Additional specifications are identified by adding (01), (02), etc.
⑤ Shell Type P : Plug R : Receptacle J : Jack		⑪ Contact Type	1 : Loose Contacts 2 : Reel Contacts
		⑫ Design	1 : If the design of contacts of the same size differs, 1, 2, 3 etc. are added to distinguish them
⑥ Serial Symbol		⑬ Contact Area Plating	1 : Gold Plated

Connector Mating Combinations Diagram

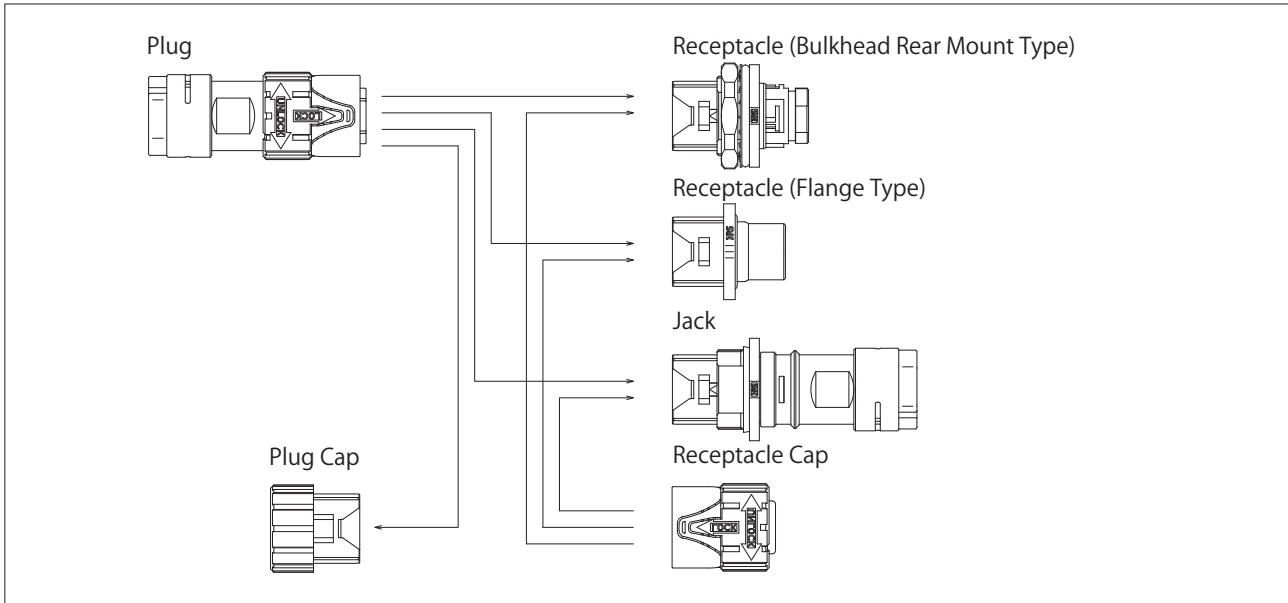

● Connector

Plug	Receptacle	Jack
HR41A-17WBPA-5SC(81)	HR41A-17WBRA-5PC(81) HR41A-17WBRB-5PC(81)	HR41A-17WBJ-5PC(81) HR41A-17WBJB-5PC(81) HR41A-17WBJD-5PC(81) HR41A-17WBJF-5PC(81)
HR41A-17WPAB-5SC(81)		
HR41A-17WPAD-5SC(81)		
HR41A-17WP AE-5SC(81)		
HR41A-17WP AF-5SC(81)		
HR41A-17WBP-3PC(81)	HR41A-17WBRA-3SC(81)	-
HR41A-17WP AB-3PC(81)		

● Plug Cap

Plug	Cap
HR41A-17WBPA-5SC(81)	HR41A-17WBP-C(81)
HR41A-17WPAB-5SC(81)	
HR41A-17WPAD-5SC(81)	
HR41A-17WP AE-5SC(81)	
HR41A-17WP AF-5SC(81)	
HR41A-17WBP-3PC(81)	
HR41A-17WP AB-3PC(81)	

● Receptacle/Jack Cap

Receptacle/Jack	Cap
HR41A-17WBRA-5PC(81)	HR41A-17WBR-C(81)
HR41A-17WBRB-5PC(81)	
HR41A-17WBRA-3SC(81)	
HR41A-17WBJ-5PC(81)	
HR41A-17WBJB-5PC(81)	
HR41A-17WBJD-5PC(81)	
HR41A-17WBJF-5PC(81)	

Plug

● 5pos. Type

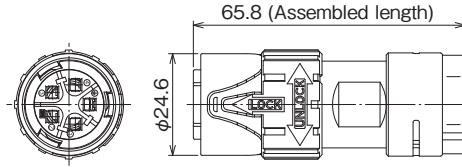

Part No.	HRS No.	No. of Pos.	Applicable Cable Diameter	Remarks	Purchase Unit
HR41A-17WBPAE-5SC(81)	CL0141-0223-9-81	5	φ 7.4 to 8.2	Sequential Mating	20pcs per bag (Note 2)
HR41A-17WBPAD-5SC(81)	CL0141-0226-7-81		φ 8.2 to 9.0		
HR41A-17WBPAE-5SC(81)	CL0141-0210-7-81		φ 9.0 to 9.8		10pcs per bag (Note 3)
HR41A-17WBPAF-5SC(81)	CL0141-0228-0-81		φ 9.9 to 10.7		
HR41A-17WBPA-5SC(81)	CL0141-0203-1-81		φ 10.7 to 11.5		

Note 1 : Please refer to the specification document for details on the sequential mating design.

Note 2 : Orders are accepted in multiples of 20pcs.

Note 3 : Orders are accepted in multiples of 10pcs.

● 3pos. Type

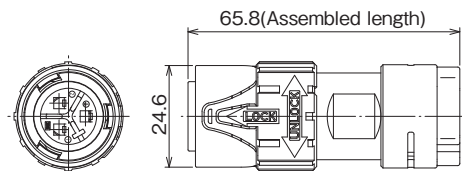

Part No.	HRS No.	No. of Pos.	Applicable Cable Diameter	Remarks	Purchase Unit
HR41A-17WBPAE-3PC(81)	CL0141-0232-0-81	3	φ 9.0 to 9.8	-	20pcs per bag (Note 1)
HR41A-17WBP-3PC(81)	CL0141-0217-6-81		φ 10.7 to 11.5	-	10pcs per bag (Note 2)

Note 1 : Orders are accepted in multiples of 20pcs.

Note 2 : Orders are accepted in multiples of 10pcs.

Receptacle

● Bulkhead Rear Mount Type (5pos. Type)

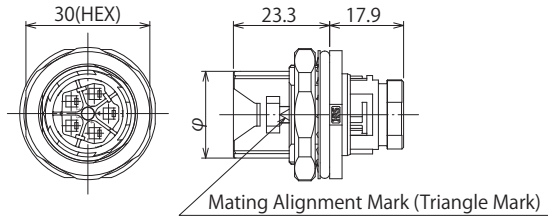

Part No.	HRS No.	No. of Pos.	Purchase Unit
HR41A-17WBRA-5PC(81)	CL0141-0201-6-81	5	10pcs per bag (Note)

Note : Orders are accepted in multiples of 10pcs.

● Bulkhead Rear Mount Type (3pos. Type)

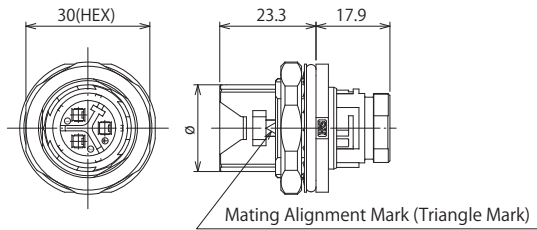

Part No.	HRS No.	No. of Pos.	Remarks	Purchase Unit
HR41A-17WBRA-3SC(81)	CL0141-0218-9-81	3	Sequence Mating	20pcs per bag (Note 2)

Note 1 : Please refer to the specification document for details on the sequential mating design.
 Note 2 : Orders are accepted in multiples of 20pcs.

● Flange Type (5pos.)

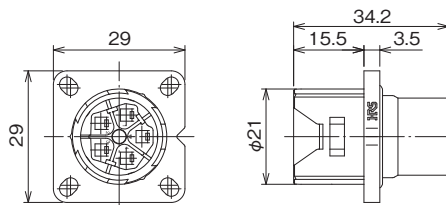

Part No.	HRS No.	No. of Pos.	Purchase Unit
HR41A-17WBRB-5PC(81)	CL0141-0222-6-81	5	20pcs per bag (Note)

Note : Orders are accepted in multiples of 20pcs.

Jack

● 5pos. Type

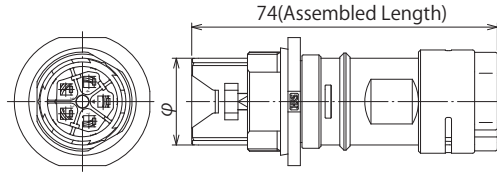

Part No.	HRS No.	No. of Pos.	Applicable Cable Diameter	Purchase Unit
HR41A-17WBJD-5PC(81)	CL0141-0216-3-81	5	φ 8.2 to 9.0	10pcs per bag (Note)
HR41A-17WBJB-5PC(81)	CL0141-0212-2-81		φ 9.0 to 9.8	
HR41A-17WBjf-5PC(81)	CL0141-0229-5-81		φ 9.9 to 10.7	
HR41A-17WBJ-5PC(81)	CL0141-0202-9-81		φ 10.7 to 11.5	

Note : Orders are accepted in multiples of 10pcs.

Caps

● Plug Cap

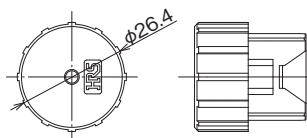

Part No.	HRS No.	Applicable Connectors	Purchase Unit
HR41A-17WBP-C(81)	CL0141-0219-1-81	HR41A-17WBPA-5SC(81) HR41A-17WPAB-5SC(81) HR41A-17WPAD-5SC(81) HR41A-17WBPAE-5SC(81) HR41A-17WBP AF-5SC(81) HR41A-17WBP-3PC(81) HR41A-17WPAB-3PC(81)	20pcs per bag (Note)

Note : Orders are accepted in multiples of 20pcs.

● Receptacle/Jack Cap

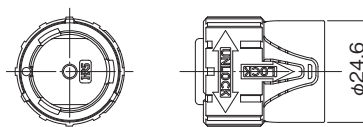

Part No.	HRS No.	Applicable Connectors	Purchase Unit
HR41A-17WBR-C(81)	CL0141-0220-0-81	HR41A-17WBRA-5PC(81) HR41A-17WBRB-5PC(81) HR41A-17WBRA-3SC(81) HR41A-17WB J-5PC(81) HR41A-17WB JB-5PC(81) HR41A-17WB JD-5PC(81) HR41A-17WB JF-5PC(81)	20pcs per bag (Note)

Note : Orders are accepted in multiples of 20pcs.

Crimp Contacts

● Female Contact Gold Plated

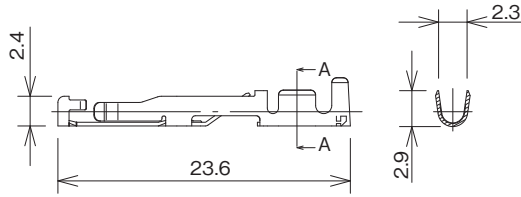

Type	Part No.	HRS No.	Plating Thickness of Contact Portion	Applicable Cable	Remarks
Loose Contacts (Note 1)	HR41A-SC-111	CL0141-0213-5-00	Gold : 0.76 μ m	16 to 20 AWG 0.52 to 1.31mm ²	100pcs per bag (Note 3)
	HR41A-SC-111(01)	CL0141-0213-5 01	Gold : 0.2 μ m		
Reel Contacts (Note 2)	HR41A-SC-211	CL0141-0206-0-00	Gold : 0.76 μ m		5,000pcs per reel
	HR41A-SC-211(01)	CL0141-0206-0-01	Gold : 0.2 μ m		

Note 1 : Use a cable with an outer diameter of ϕ 1.9- 2.55.

Note 2 : Use a cable with an outer diameter of ϕ 1.9- 3.2.

Note 3 : Orders are accepted in bag increments.

Silver Plated

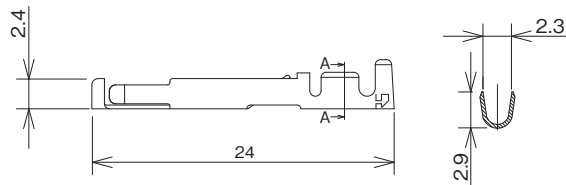
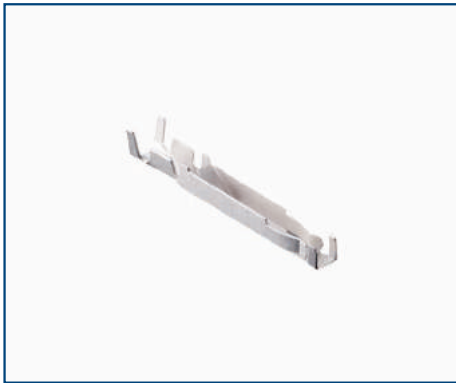

Type	Part No.	HRS No.	Plating Thickness of Contact Portion	Applicable Cable	Remarks
Loose Contacts	JRC-SC-112	CL0114-0241-8-00	Silver : 5 μ m	16 to 20 AWG 0.52 to 1.31mm ²	100pcs per bag (Note 2)
Reel Contacts	JRC-SC-212	CL0114-0242-0-00			5,000pcs per reel

Note 1 : Use a cable with an outer diameter of ϕ 1.9- 2.55.

Note 2 : Orders are accepted in bag increments.

● Male Contact Gold Plated

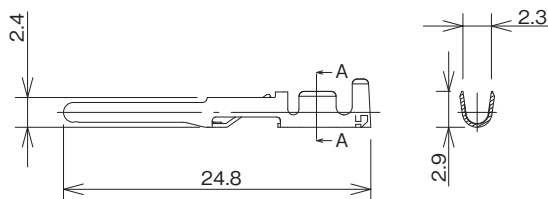

Type	Part No.	HRS No.	Plating Thickness of Contact Portion	Applicable Cable	Remarks
Loose Contacts (Note 1)	HR41A-PC-111	CL0141-0214-8-00	Gold : 0.76 μ m	16 to 20 AWG 0.52 to 1.31mm ²	100pcs per bag (Note 3)
	HR41A-PC-111(01)	CL0141-0214-8-01	Gold : 0.2 μ m		
Reel Contacts (Note 2)	HR41A-PC-211	CL0141-0207-2-00	Gold : 0.76 μ m		5000pcs per reel
	HR41A-PC-211(01)	CL0141-0207-2-01	Gold : 0.2 μ m		

Note 1 : Use a cable with an outer diameter of ϕ 1.9- 2.55.

Note 2 : Use a cable with an outer diameter of ϕ 1.9- 3.2.

Note 3 : Orders are accepted in bag increments.

Silver Plated

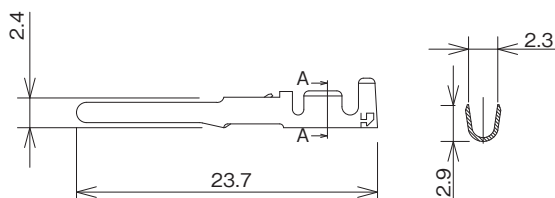

Type	Part No.	HRS No.	Plating Thickness of Contact Portion	Applicable Cable	Remarks
Loose Contacts	JRC-PC-112	CL0114-0239-6-00	Silver : 5 μ m	16 to 20 AWG 0.52 to 1.31mm ²	100pcs per bag (Note 2)
Reel Contacts	JRC-PC-212	CL0114-0240-5-00			5000pcs per reel

Note 1 : Use a cable with an outer diameter of ϕ 1.9- 2.55.

Note 2 : Orders are accepted in bag increments.

Receptacle Panel Mounting Hole Dimensions

Bulkhead, Rear Mount Type

$t=2.0(\text{Max.})$

Mating Guide Position

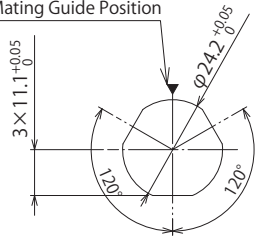

Flange Type

Minimum Mounting Dimensions

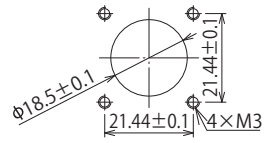

Maximum Mounting Dimensions

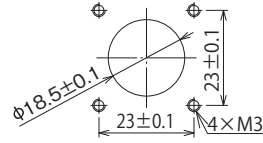

Applicable tools

- Manual Crimp Tool
- Manual Crimp Tool
- Automatic Crimp Press



HT802/HR41A-11



JRC-TC-11, JRC-TC-12



CM-105C

- Extraction Tool



HR41A-TP

Type	Items	Part No.	HRS No.	Applicable Contacts	Applicable Cable
Manual	Manual Crimp Tool (Note)	HT802/ HR41A-11-16	CL0150-0408-5-00	HR41A-SC-111 HR41A-PC-111	16 AWG Jacket Outer Diameter : φ 1.9 to 2.55
		HT802/ HR41A-11-18	CL0150-0404-4-00		18 AWG Jacket Outer Diameter : φ 1.9 to 2.55
		HT802/ HR41A-11-20	CL0150-0407-2-00		20 AWG Jacket Outer Diameter : φ 1.9 to 2.55
		JRC-TC-11	CL0150-0033-4-00	JRC-PC-112 JRC-SC-112	16 AWG Jacket Outer Diameter : φ 1.9 to 2.55
		JRC-TC-12	CL0150-0034-7-00	JRC-PC-112 JRC-SC-112	18 to 20 AWG Jacket Outer Diameter : φ 1.9 to 2.55
Automatic	Automatic Crimp Press	CM-105C	CL0901-0001-0-00	-	-
	Press Applicator (Note)	AP105-HR41A-1	CL0901-2055-3-00	HR41A-SC-211 HR41A-PC-211	16 to 20 AWG Jacket Outer Diameter : φ 1.9 to 3.2
		AP105-JRC-1	CL0901-2039-7-00	JRC-PC-212 JRC-SC-212	16 to 20 AWG Jacket Outer Diameter : φ 1.9 to 2.55
	Extraction Tool	HR41A-TP	CL0150-0405-7-00	-	-

(Note) When using a cable with jacket outer diameter of φ 2.55 to 3.2, use AP105-HR41A-1.

Connector Usage Precautions

1. Assembly and installation of connectors and components should be done in reference to the specified assembly procedures and with the proper amount of tightening torque.
If the torque is too low or too strong it may result in loosening or damage.
(Please contact your Hirose representative for the correct procedures.)
2. After mating a connector, pull on the cable slightly to confirm the connector is firmly in place.

While Taking into Consideration

Specifications mentioned in this catalog are reference values.

When considering to order or use this product, please confirm the Drawing and Product Specifications sheets.

Use an appropriate cable when using the connector in combination with cables.

If considering usage of a non-specified cable, please contact your sales representative.

If assembly process is done by jigs & tools which are not identified by Hirose, assurance will not be given.

If considering usage for below mentioned applications, please contact your sales representative.

In cases where the application will demand a high level of reliability, such as automotive, medical instruments, public infrastructure, aerospace/ defense etc. Hirose must review before assurance of reliability can be given.

HIROSE



HIROSE ELECTRIC CO.,LTD.

2-6-3 Nakagawa Chuoh, Tsuzuki-Ku, Yokohama-Shi 224-8540, JAPAN
<https://www.hirose.com>