



Photocoupler
Product Data Sheet
LTV-3213

Spec No. :DS70-2018-0163
Effective Date: 01/10/2019
Revision: A

LITE-ON DCC

RELEASE

BNS-OD-FC001/A4

Photocoupler LTV-22X3 series LTV-32X3 series

1. DESCRIPTION

Solid State Relays (SSR) are integration of an AlGaAs Light Emitting Diode, a Phototriac Detector and a main power Triac. These devices are ideally suited for controlling high voltage AC loads with solid state reliability while providing 5 KV isolation ($V_{iso}(rms)$) between input to output.

1.1 Features

- 8 pin DIP package
- High repetitive peak off-state voltage V_{DRM} : Min. 600 V
- Isolation voltage between input and output V_{iso} : 5,000 V_{rms}
- Safety approval
VDE DIN EN 60747-5-5 / IEC 60747-5-5
UL 1577 (E113898)
UL 508 (E490256)
CUL CA5A (E113898)
CQC GB4943.1-2011/GB8898-2011 (meet Altitude up to 5000m)
DEMKO IEC/EN62368-1; IEC/EN 60950-1; IEC/EN 60065
- RoHS Compliance
All materials be used in device are followed EU RoHS directive (No.2002/95/EC)

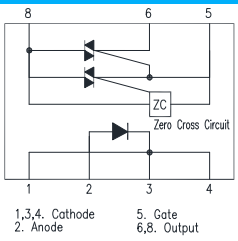
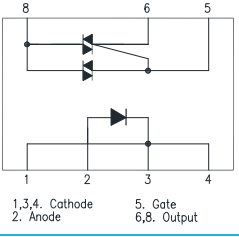
Part Number	Output Rating			Functional Diagram
	Peak Off-state Voltage	On-state RMS Current	Type	
LTV-2213	600 V	0.9 A	Zero-Crossing	
LTV-3213		1.2 A		
LTV-2223		0.9 A	Random Phase	
LTV-3223		1.2 A		

1.2 Applications

- Home appliances
- Industrial equipment

Photocoupler LTV-22X3 series LTV-32X3 series

2. PACKAGE DIMENSIONS

2.1 Through Hole

LTV-X2X3

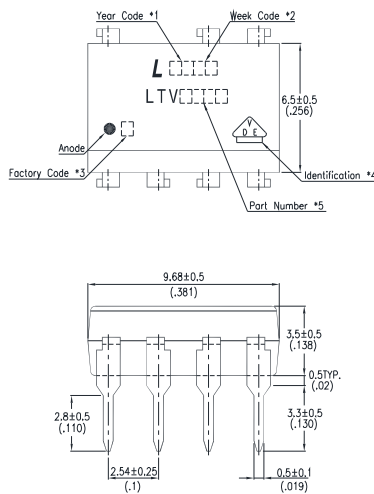

2.2 Wide Lead

LTV-X2X3M

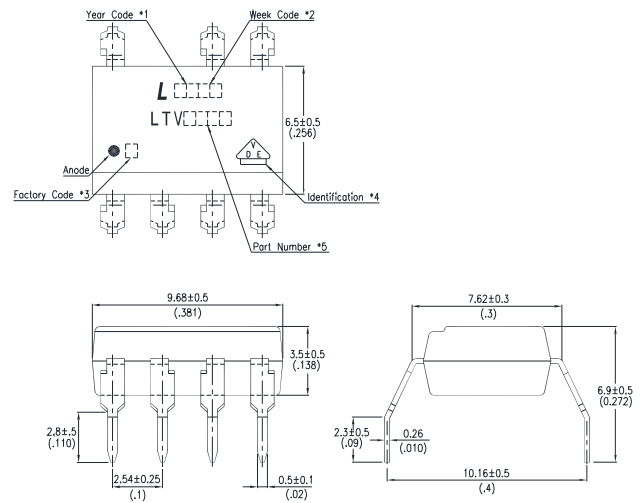

2.3 SMT

LTV-X2X3S

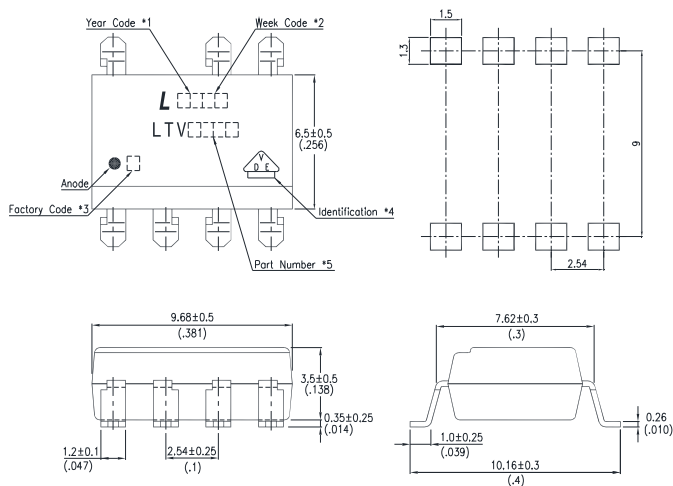

Notes:

1. 2-digit year code
2. 2-digit work week code
3. Factory identification mark shall be marked (W: China-CZ, Y: Thailand)
4. VDE option
5. Part number (LTV2213, LTV2223, LTV3213, LTV3223)

Dimensions in millimeters (inches)

Photocoupler LTV-22X3 series LTV-32X3 series

3. TAPING DIMENSIONS

3.1 LTV-22X3S-TA

LTV-32X3S-TA

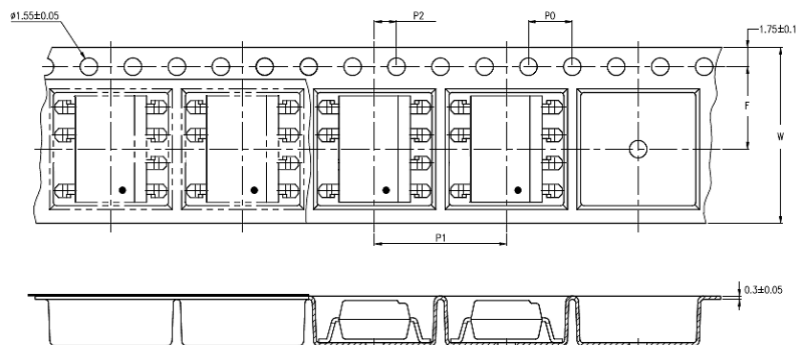

3.2 LTV-22X3S-TA1

LTV-32X3S-TA1

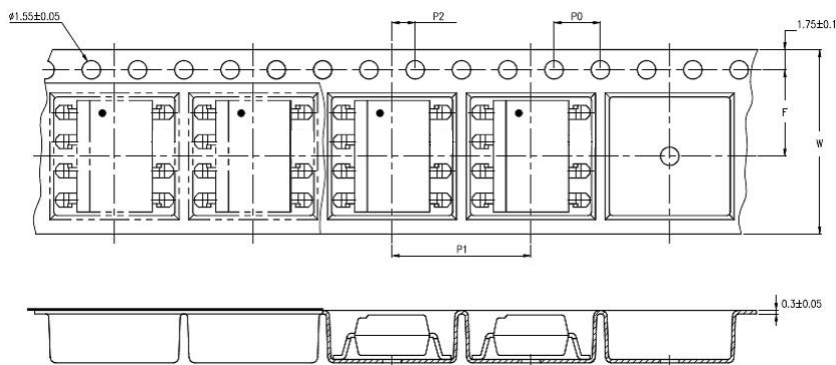

Description	Symbol	Dimension in mm (inch)
Tape wide	W	16±0.3 (0.63)
Pitch of sprocket holes	P ₀	4±0.1 (0.15)
Distance of compartment	F	7.5±0.1 (0.295)
	P ₂	2±0.1 (0.079)
Distance of compartment to compartment	P ₁	12±0.1 (0.47)

3.3 Quantities Per Reel

Package Type	LTV-22X3 series LTV-32X3 series
Quantities (pcs)	1000

Photocoupler LTV-22X3 series LTV-32X3 series

4. RATING AND CHARACTERISTICS

4.1 Absolute Maximum Ratings at Ta=25°C

Parameter		Symbol	Rating	Unit
Input	Forward Current	I_F	50	mA
	Reverse Voltage	V_R	6	V
	Peak Forward Current	I_{FP}	1	A
	Junction Temperature	T_J	125	°C
	Power Dissipation	P_{in}	140	mW
Output	Repetitive peak OFF-state voltage	V_{DRM}	600	V
	ON-state RMS current	LTV-2213, LTV-2223	0.9	A
		LTV-3213, LTV-3223	1.2	
	Non-repetitive Surge current *3	LTV-2213, LTV-2223	9	A
		LTV-3213, LTV-3223	12	
Power Dissipation	P_{out}	1100	mW	
*1.	Isolation Voltage	V_{iso}	5000	V_{rms}
	Operating Temperature	T_{opr}	-30 ~ +85	°C
	Storage Temperature	T_{stg}	-40 ~ +125	°C
*2.	Soldering Temperature	T_{sol}	260	°C

1. AC For 1 Minute, R.H. = 40 ~ 60%
Isolation voltage shall be measured using the following method.
 - (1) Short between anode and cathode on the primary side and between collector and emitter on the secondary side.
 - (2) The isolation voltage tester with zero-cross circuit shall be used.
 - (3) The waveform of applied voltage shall be a sine wave.
2. For 10 Seconds
3. Sine wave; f=60Hz, 1 cycle

Photocoupler LTV-22X3 series LTV-32X3 series

4.2 ELECTRICAL OPTICAL CHARACTERISTICS at Ta=25°C

		Symbol	Min.	Typ.	Max.	Unit	Test Condition
Input	Forward Voltage	V_F	—	1.2	1.3	V	$I_F=20\text{mA}$
	Reverse Current	I_R	—	—	10	μA	$V_R=6\text{V}$
Output	Peak Blocking Current, Either Direction	I_{DRM}	—	—	100	μA	$I_F=0\text{mA}$ $V_{DRM} = 600\text{V}$
	Peak On-State Voltage, Either Direction	V_{TM}	—	—	2.5	V	$I_F = 10\text{mA}$ $I_{TM} = \text{Max.}$
	Critical rate of Rise of Off-State Voltage	dv/dt	200	—	—	$\text{V}/\mu\text{s}$	$V_{DRM} = 600\text{V} \cdot 1/\sqrt{2}$
Transfer characteristics	Led Trigger Current, Current Required to Latch Output, Either Direction	I_{FT}	—	—	10	mA	$V_D = 6\text{V}$ $R_L = 100\ \Omega$
	Holding Current, Either Direction	I_H	—	—	25	mA	
	Zero Crossing Voltage (LTV-X213 Series)	V_{ZC}	—	—	50	V	$I_F = 10\text{mA}$
	Turn on time	T_{ON}	—	—	100	μs	$I_F = 20\text{mA}$ $V_D = 6\text{V}$ $R_L = 100\ \Omega$
	I/O isolation resistance	R_{ISO}	5×10^{10}	10^{11}	—	Ω	500V DC

5. CHARACTERISTICS CURVES (TYPICAL PERFORMACNE) AND TESTING DIAGRAM

Fig 1. ON-state RMS current vs.
Ambient Temperature

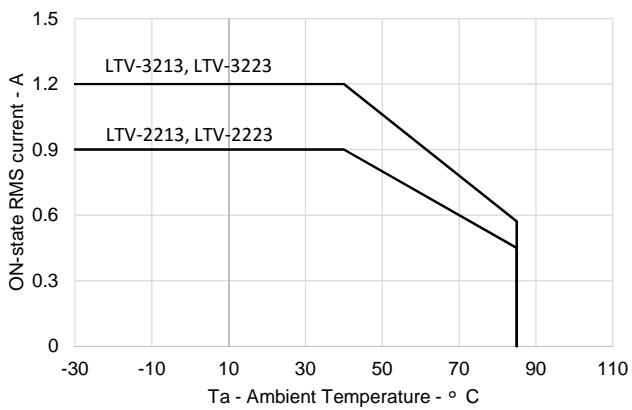

Fig 2. Peak ON-state voltage vs.
Ambient Temperature

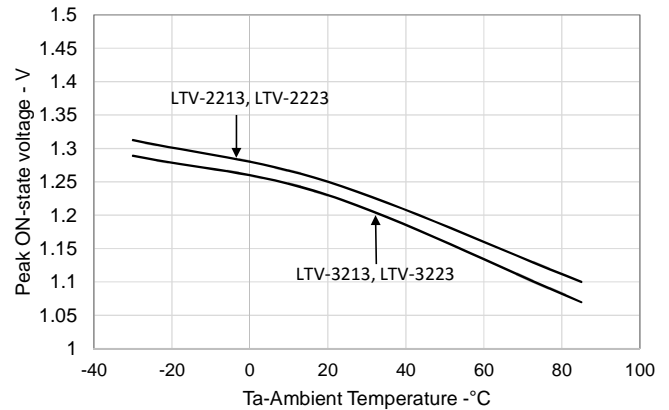

Fig 3. Trigger LED current vs.
Ambient Temperature

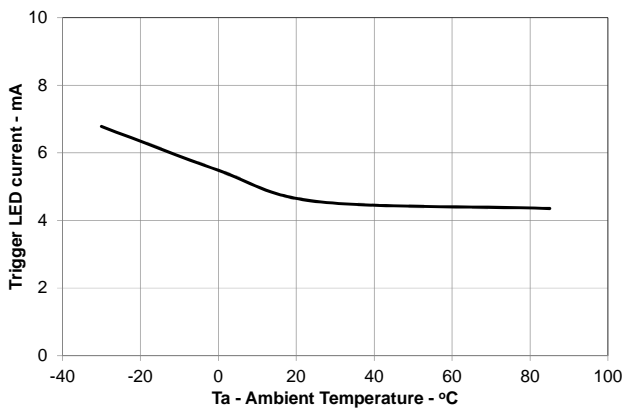
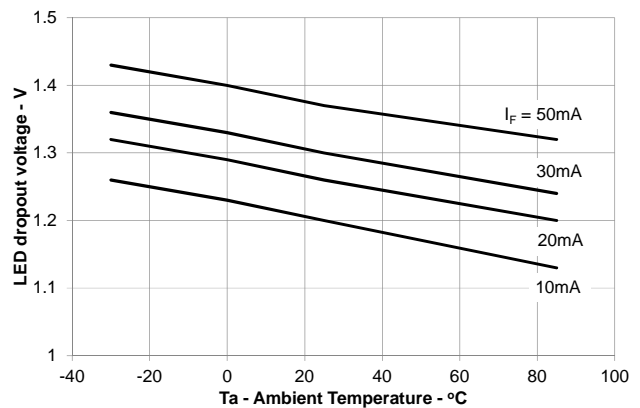

Fig 4. LED dropout voltage vs.
Ambient Temperature



Photocoupler LTV-22X3 series LTV-32X3 series

Fig 5. Turn on time vs. LED current

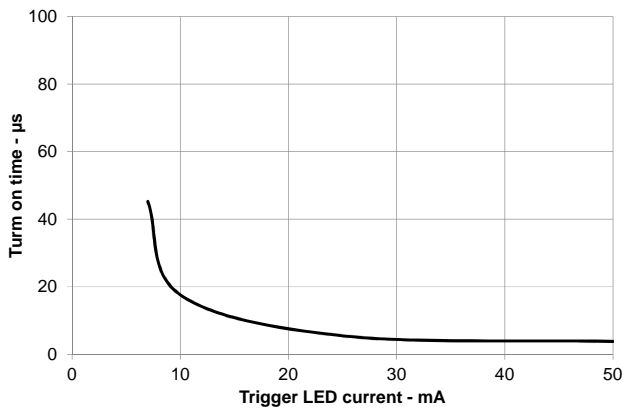

Fig 6. Repetitive peak OFF-state current vs. Load voltage

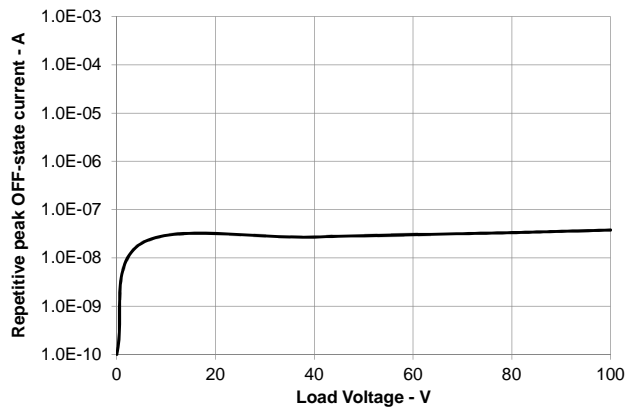

Fig 7. Hold current vs. Ambient Temperature

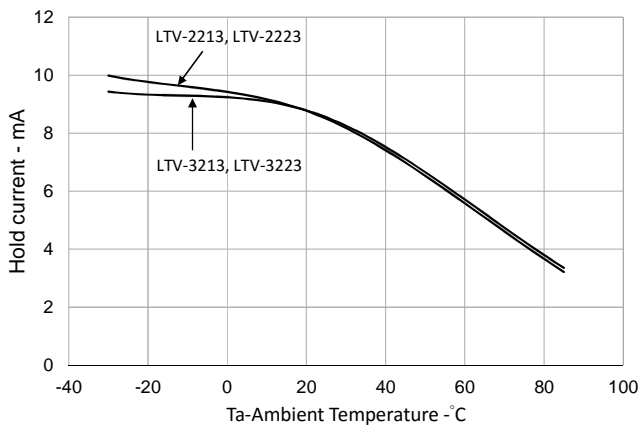

Fig.8 Testing diagram of Turn on time

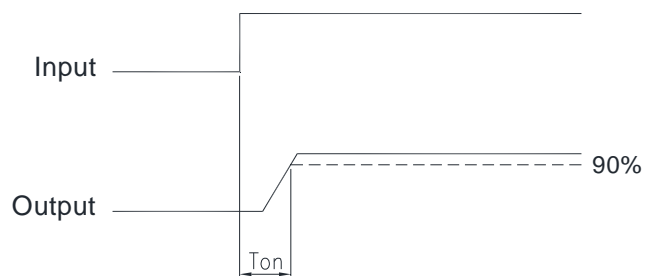
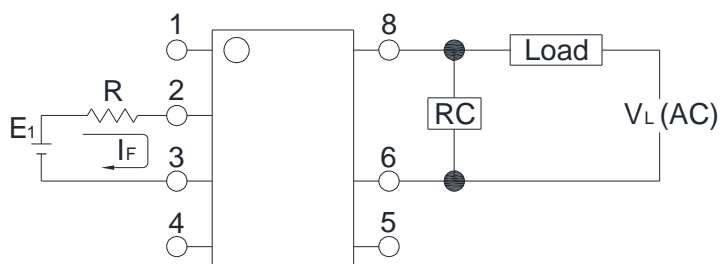

Fig 9. Basic diagrams



RC: Snubber circuit

Photocoupler LTV-22X3 series LTV-32X3 series

6. TEMPERATURE PROFILE OF SOLDERING

6.1 IR Reflow soldering (JEDEC-STD-020C compliant)

One time soldering reflow is recommended within the condition of temperature and time profile shown below. Do not solder more than twice.

Profile item	Conditions
Preheat	
- Temperature Min (T_{Smin})	150°C
- Temperature Max (T_{Smax})	200°C
- Time (min to max) (ts)	90±30 sec
Soldering zone	
- Temperature (T_L)	217°C
- Time (t_L)	60 sec
Peak Temperature (T_P)	260°C
Ramp-up rate	3°C / sec max.
Ramp-down rate	3~6°C / sec

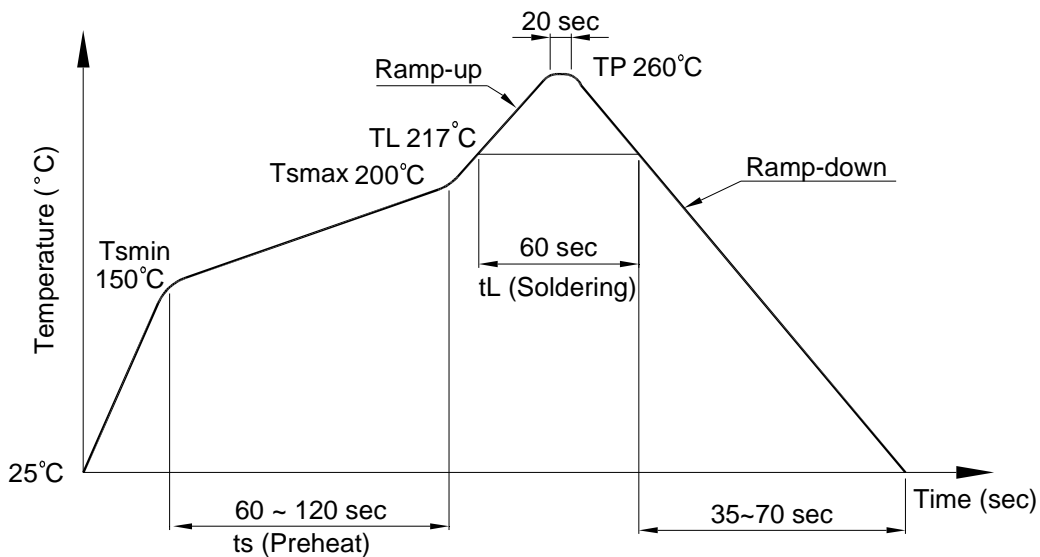

Photocoupler LTV-22X3 series LTV-32X3 series

6.2 Wave soldering (JEDEC22A111 compliant)

One time soldering is recommended within the condition of temperature.

Temperature: $260+0/-5^{\circ}\text{C}$

Time: 10 sec.

Preheat temperature: 25 to 140°C

Preheat time: 30 to 80 sec.

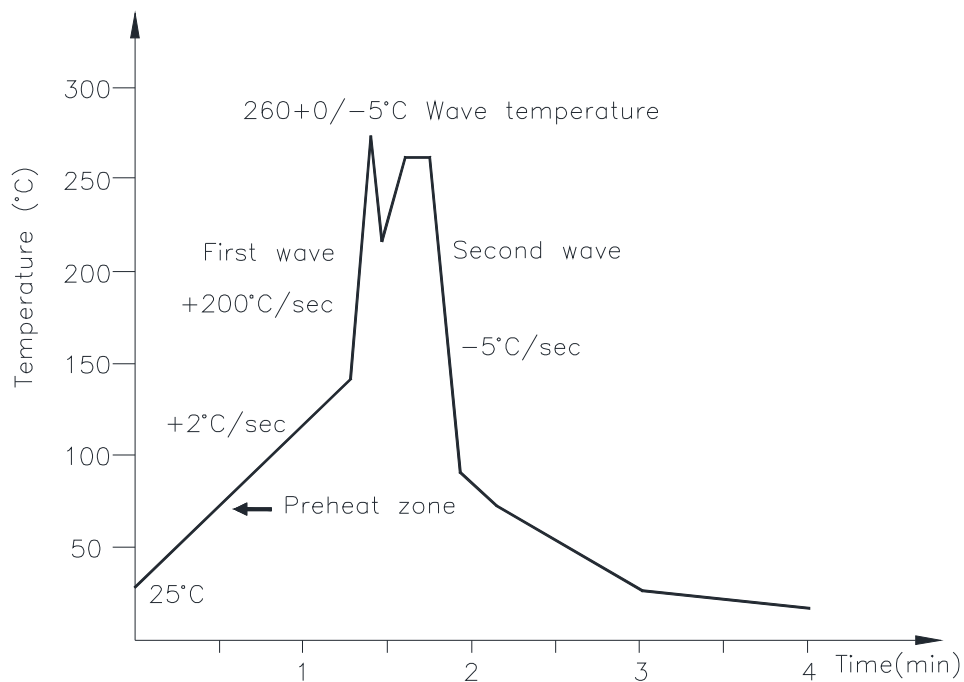

6.3 Hand soldering by soldering iron

Allow single lead soldering in every single process. One time soldering is recommended.

Temperature: $380+0/-5^{\circ}\text{C}$

Time: 3 sec max.

7. NAMING RULE

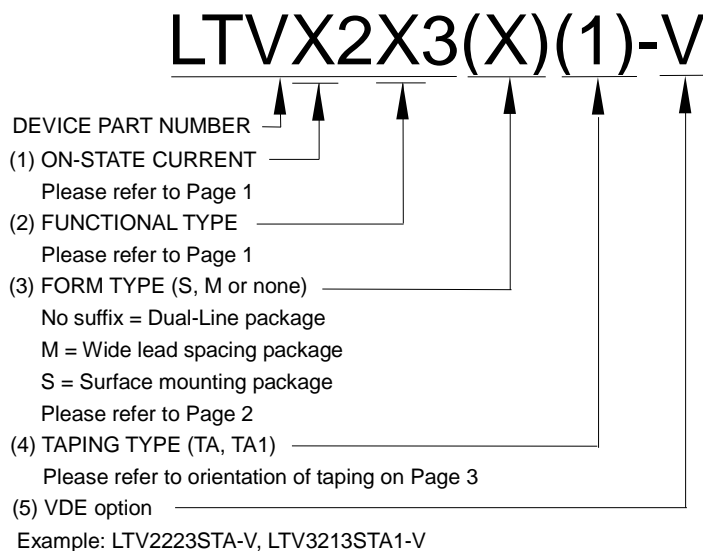
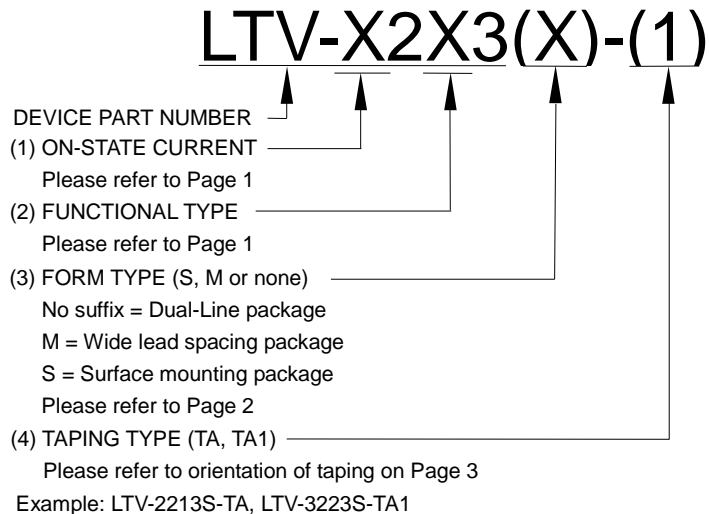

8. NOTES

1. LiteOn is continually improving the quality, reliability, function or design and LiteOn reserves the right to make changes without further notices.
2. The products shown in this publication are designed for the general use in electronic applications such as office automation equipment, communications devices, audio/visual equipment, electrical application and instrumentation.
3. For equipment/devices where high reliability or safety is required, such as space applications, nuclear power control equipment, medical equipment, etc, please contact our sales representatives.
4. When requiring a device for any "specific" application, please contact our sales in advice.
5. If there are any questions about the contents of this publication, please contact us at your convenience.
6. The contents described herein are subject to change without prior notice.
7. Immerge unit's body in solder paste is not recommended.