

DELIVERY SPECIFICATION

SPEC. No. C2024-FA

D A T E : May 2024

To

Non-Controlled Copy

CUSTOMER'S PRODUCT NAME

TDK'S PRODUCT NAME

Multilayer Ceramic Capacitors
Dipped Radial Lead Type
FA18, FA14, FA16, FA11,
FA28, FA24, FA26, FA20, FA22, FA23 Type
【Halogen-free, RoHS2 compliant】

Please return this specification to TDK representatives with your signature.
If orders are placed without returned specification, please allow us to judge that specification is accepted by your side.

RECEIPT CONFIRMATION

DATE: _____ YEAR _____ MONTH _____ DAY _____

Test conditions in this specification based on AEC-Q200 for automotive application.

TDK Corporation

Sales

Electronic Components

Sales & Marketing Group

Engineering

Electronic Components Business Company

Ceramic Capacitors Business Group

APPROVED	Person in charge

APPROVED	CHECKED	Person in charge

SCOPE

This delivery specification shall be applied to Multilayer ceramic capacitors Dipped Radial Lead type to be delivered to_____.

PRODUCTION PLACES

Production places defined in this specification shall be TDK Xiamen Co., (China).

PRODUCT NAME

The name of the product to be defined in this specifications shall be FA○○△△△□□□×××◎****.

REFERENCE STANDARD

JIS	C 5101-1	Fixed capacitors for use in electronic equipment-Part 1 : Generic specification
	C 0806-2	Packaging of components for automatic handing-Part 2 : Packaging of components with unidirectional leads on continuous tapes
JEITA	RCR-2335 C	Safety application guide for fixed ceramic capacitors for use in electronic equipment

CONTENTS

1. CODE CONSTRUCTION
2. COMBINATION OF RATED CAPACITANCE AND TOLERANCE
3. OPERATING TEMPERATURE RANGE
4. STORING CONDITION AND TERM
5. INDUSTRIAL WASTE DISPOSAL
6. PERFORMANCE
7. INDICATION
8. INSIDE STRUCTURE AND MATERIAL
9. PACKAGING
10. CAUTION
11. TAPE PACKAGING SPECIFICATION

<EXPLANATORY NOTE>

When the mistrust in the spec arises, this specification is given priority. And it will be confirmed by written spec change after conference of both posts involved.

This specification warrants the quality of the ceramic capacitor. Capacitors should be evaluated or confirmed a state of mounted on your product.

If the use of the capacitors goes beyond the bounds of this specification, we can not afford to guarantee.

Division	Date	SPEC. No.
Ceramic Capacitors Business Group	May 2024	C2024-FA

1. CODE CONSTRUCTION

(Example) FA28 X7R 1H 104 K NU0 6
 (1) (2) (3) (4) (5) (6) (7)

(1) Case size

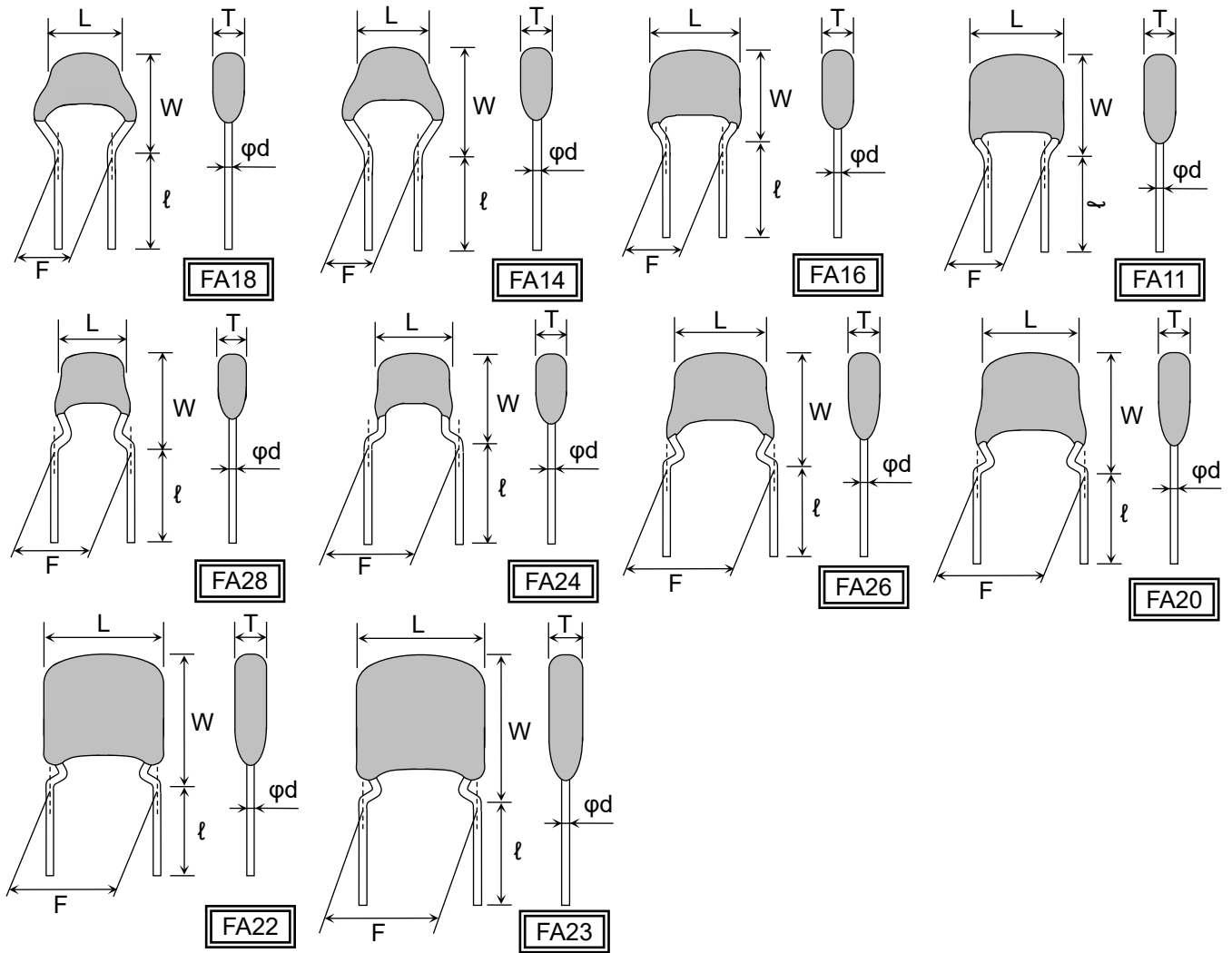

Case size *1	Dimensions (mm)					
	L(max.) *2	W(max.)	T(max.)	F *3	l *3	φd
FA18	4.0	5.5	2.5	2.5±0.8	7.0±2.0	0.5 ^{+0.10} _{-0.03}
FA14	4.5	5.5	3.0			
FA16	5.5	6.0	3.5			
FA11	5.5	7.0	4.0			
FA28	4.0	5.5	2.5	5.0±1.0	7.0±2.0	0.5 ^{+0.10} _{-0.03}
FA24	4.5	5.5	3.0			
FA26	5.5	6.0	3.5			
FA20	5.5	7.0	4.0			
FA22	7.5	8.5	4.5			
FA23	8.5	11.0	5.5			

*1 FA denotes forming lead.

The first digit refers to a distance between leads (1:2.5mm, 2:5.0mm), the second digit is for TDK internal code.

*2 The FA18, FA14, FA28 and FA24 types represent dimensions 1 mm below the top of the body.

Other types represent the dimensions of the central part of the body.

*3 Dimension F and l is applied to bulk packaging.

The measurement point of F dimensions is 1.5 to 2.0mm below the kink.

Refer to Appendix 2 and 3 for dimension of taping packaging.

*4 As for each item, please refer to detail page on TDK web.

(2) Temperature Characteristics (Details are shown in para 6 No.7,8)

(3) Rated Voltage

Symbol	Rated Voltage
2 J	DC 630 V
2 W	DC 450 V
2 E	DC 250 V
2 A	DC 100 V
1 H	DC 50 V
1 E	DC 25 V

(4) Rated Capacitance

Stated in three digits and in units of pico farads (pF). The first and second digits identify the first and second significant figures of the capacitance, the third digit identifies the multiplier. R is designated for a decimal point.

(Example)

Symbol	Rated Capacitance
2R2	2.2pF
104	100,000pF

(5) Capacitance tolerance

Symbol	Tolerance	Capacitance(C)
C	± 0.25 pF	$C \leq 5$ pF
D	± 0.5 pF	5 pF $< C \leq 10$ pF
J	± 5 %	Over 10pF
K	± 10 %	
M	± 20 %	

(6) Internal code

(7) Packaging

Symbol	Packaging
0	Bulk
6	Ammo Pack

2. COMBINATION OF RATED CAPACITANCE AND TOLERANCE

Class	Temperature Characteristics	Capacitance tolerance		Rated capacitance(C)
1	C0G NP0	$C \leq 5 \text{ pF}$	C ($\pm 0.25 \text{ pF}$)	1, 1.5, 2, 2.2, 3.3, 4, 4.7
		$5 \text{ pF} < C \leq 10 \text{ pF}$	D ($\pm 0.5 \text{ pF}$)	6.8, 10
		$10 \text{ pF} < C \leq 10,000 \text{ pF}$	J ($\pm 5 \%$)	E-12 series
		$10,000 \text{ pF} < C$	J ($\pm 5 \%$)	E-6 series
2	X7R X7S X7T X8R X8L	$C \leq 10 \mu\text{F}$	K ($\pm 10 \%$)	E-6 series
		$10 \mu\text{F} < C$	M ($\pm 20 \%$)	

Capacitance Step in E series

E series	Capacitance Step											
E-6	1.0		1.5		2.2		3.3		4.7		6.8	
E-12	1.0	1.2	1.5	1.8	2.2	2.7	3.3	3.9	4.7	5.6	6.8	8.2

3. OPERATING TEMPERATURE RANGE

T.C.	Min. operating Temperature	Max. operating Temperature	Reference Temperature
C0G	-55°C	125°C	25°C
NP0	-55°C	150°C	25°C
X7R/X7S/X7T	-55°C	125°C	25°C
X8R/X8L	-55°C	150°C	25°C

4. STORING CONDITION AND TERM

Storing temperature	Storing humidity	Storing term
5~40°C	20~70%RH	Within 6 months upon receipt.

5. INDUSTRIAL WASTE DISPOSAL

Dispose this product as industrial waste in accordance with the industrial Waste Law.

6. PERFORMANCE

Table 1

No.	Item		Performance	Test or inspection method																	
1	External Appearance		No defects which may affect performance.	By visual checking.																	
2	Indication	Appearance	Meet a requirement per para 7.	<table border="1"> <thead> <tr> <th>Solvent</th> <th>Solvent temp.</th> <th>Dipping time</th> </tr> </thead> <tbody> <tr> <td>Isopropyl alcohol</td> <td>20~25°C</td> <td>30±5s.</td> </tr> </tbody> </table>	Solvent	Solvent temp.	Dipping time	Isopropyl alcohol	20~25°C	30±5s.											
		Solvent	Solvent temp.		Dipping time																
Isopropyl alcohol	20~25°C	30±5s.																			
Resistance to solvent	Shall be visible.																				
3	Voltage Proof	Between termination	No insulation breakdown or other damage.	<table border="1"> <thead> <tr> <th>Class</th> <th>Rated voltage(RV)</th> <th>Apply voltage</th> </tr> </thead> <tbody> <tr> <td rowspan="3">1</td> <td>$RV \leq 100V$</td> <td>3 × rated voltage</td> </tr> <tr> <td>$100V < RV \leq 500V$</td> <td>1.5 × rated voltage</td> </tr> <tr> <td>$500V < RV$</td> <td>1.3 × rated voltage</td> </tr> <tr> <td rowspan="3">2</td> <td>$RV \leq 100V$</td> <td>2.5 × rated voltage</td> </tr> <tr> <td>$100V < RV \leq 500V$</td> <td>1.5 × rated voltage</td> </tr> <tr> <td>$500V < RV$</td> <td>1.3 × rated voltage</td> </tr> </tbody> </table> <p>Voltage application time : 1s. Charge / discharge current : 50mA or lower</p>	Class	Rated voltage(RV)	Apply voltage	1	$RV \leq 100V$	3 × rated voltage	$100V < RV \leq 500V$	1.5 × rated voltage	$500V < RV$	1.3 × rated voltage	2	$RV \leq 100V$	2.5 × rated voltage	$100V < RV \leq 500V$	1.5 × rated voltage	$500V < RV$	1.3 × rated voltage
		Class	Rated voltage(RV)	Apply voltage																	
	1	$RV \leq 100V$	3 × rated voltage																		
$100V < RV \leq 500V$		1.5 × rated voltage																			
$500V < RV$		1.3 × rated voltage																			
2	$RV \leq 100V$	2.5 × rated voltage																			
	$100V < RV \leq 500V$	1.5 × rated voltage																			
	$500V < RV$	1.3 × rated voltage																			
Between termination coating	No insulation breakdown or other damage.	Apply voltage : 2.5 × rated voltage (By metallic small ball method.)																			
4	Insulation Resistance		Please refer to detail page on TDK web.	Measuring voltage : Rated voltage (As for the capacitor of rated voltage 630V DC, apply 500V DC.) Voltage application time : 60s.																	
5	Capacitance		Within the specified tolerance.	As for measuring condition, please contact with our sales representative.																	
6	Q (Class 1)		Please refer to detail page on TDK web.	See No.5 in this table for measuring condition.																	
	Dissipation Factor (Class 2)																				
7	Temperature Characteristics of Capacitance (Class 1)		<table border="1"> <thead> <tr> <th>T.C.</th> <th>Temperature Coefficient (ppm/°C)</th> </tr> </thead> <tbody> <tr> <td>COG NPO</td> <td>0 ± 30</td> </tr> </tbody> </table>	T.C.	Temperature Coefficient (ppm/°C)	COG NPO	0 ± 30	Temperature Coefficient shall be calculated based on values at 25°C and 85°C temperature. Measuring temperature below 20°C shall be -10°C and -25°C													
			T.C.	Temperature Coefficient (ppm/°C)																	
COG NPO	0 ± 30																				
Capacitance drift Within ±0.2% or ±0.05pF, whichever larger.																					

(continued)

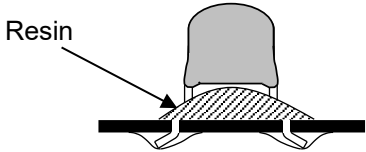
No.	Item		Performance	Test or inspection method										
8	Temperature Characteristics of Capacitance (Class 2)		<p style="text-align: center;">Capacitance Change(%)</p> <hr/> <p style="text-align: center;">No voltage applied</p> <hr/> <p style="text-align: center;">X7R : ±15</p> <p style="text-align: center;">X7S : ±22</p> <p style="text-align: center;">X7T : +22 -33</p> <p style="text-align: center;">X8R : ±15</p> <p style="text-align: center;">X8L : +15 -40</p> <hr/>	<p>Capacitance shall be measured by the steps shown in the following table, after thermal equilibrium is obtained for each step.</p> <p>ΔC be calculated ref. STEP3 reading.</p> <table border="1" style="margin-left: auto; margin-right: auto;"> <thead> <tr> <th>Step</th> <th>Temperature(°C)</th> </tr> </thead> <tbody> <tr> <td>1</td> <td>Reference temp. ±2</td> </tr> <tr> <td>2</td> <td>Min. operating temp. ±2</td> </tr> <tr> <td>3</td> <td>Reference temp. ±2</td> </tr> <tr> <td>4</td> <td>Max. operating temp. ±2</td> </tr> </tbody> </table> <p>As for Min. / Max. operating temp and Reference temp., please refer to "3. OPERATING TEMPERATURE RANGE". As for measuring condition, please contact with our sales representative.</p>	Step	Temperature(°C)	1	Reference temp. ±2	2	Min. operating temp. ±2	3	Reference temp. ±2	4	Max. operating temp. ±2
Step	Temperature(°C)													
1	Reference temp. ±2													
2	Min. operating temp. ±2													
3	Reference temp. ±2													
4	Max. operating temp. ±2													
9	Lead Strength	Tensile Strength	No mechanical damage such as lead breakage and loosing.	With holding the parts, apply pulling force to lead drawing direction gradually. Pulling strength : 10N Holding time : 10±1s.										
		Bending Strength	No mechanical damage such as lead breakage and loosing.	With holding the capacitors to keep the axis vertical, bend it 90 degrees with weighting and put it back to the original position. This operation shall be done for 2~3s. and repeat the following times. Bending forth : 5N Testing time : 2 times										
10	Mechanical Shock	External appearance	No mechanical damage.	<p>Waveform : Half-sine Acceleration : 100G max. Velocity change : 12.3ft/s. Duration : 6 msec. Shocks : 18shocks in each 3 mutually perpendicular axes.</p> <p>Solder the capacitors on a P.C.Board shown in Appendix1 before testing. For the FA23 type, fix the capacitor with resin as shown in the figure below.</p> <div style="text-align: center;">  </div>										
		Capacitance	<table border="1" style="width: 100%; border-collapse: collapse;"> <thead> <tr> <th colspan="2">Characteristics</th> <th>Change from the value before test</th> </tr> </thead> <tbody> <tr> <td style="text-align: center;">Class 1</td> <td style="text-align: center;">C0G NP0</td> <td style="text-align: center;">±2.5% or ±0.25pF, whichever larger.</td> </tr> <tr> <td style="text-align: center;">Class 2</td> <td style="text-align: center;">X7R X7S X7T X8R X8L</td> <td style="text-align: center;">±7.5 %</td> </tr> </tbody> </table>		Characteristics		Change from the value before test	Class 1	C0G NP0	±2.5% or ±0.25pF, whichever larger.	Class 2	X7R X7S X7T X8R X8L	±7.5 %	
			Characteristics		Change from the value before test									
		Class 1	C0G NP0		±2.5% or ±0.25pF, whichever larger.									
Class 2	X7R X7S X7T X8R X8L	±7.5 %												
Q (Class1)	Meet the initial spec.													
D.F. (Class2)	Meet the initial spec.													

(continued)

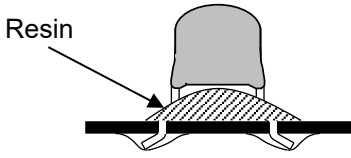
No.	Item		Performance	Test or inspection method									
11	Vibration	External appearance	No mechanical damage.	<p>Applied force : 5G max. Frequency : 10~2,000Hz Reciprocating sweep time : 20 min. Cycle : 12 cycles in each 3 mutually perpendicular directions.</p> <p>Solder the capacitors on a P.C.Board shown in Appendix 1 before testing. For the FA23 type, fix the capacitor with resin as shown in the figure below.</p> <div style="text-align: center;">  <p>Resin</p> </div>									
		Capacitance	<table border="1" style="width: 100%; border-collapse: collapse;"> <thead> <tr> <th colspan="2">Characteristics</th> <th>Change from the value before test</th> </tr> </thead> <tbody> <tr> <td rowspan="2">Class 1</td> <td>C0G NP0</td> <td>±2.5% or ±0.25pF, whichever larger.</td> </tr> <tr> <td>X7R X7S X7T X8R X8L</td> <td>±7.5 %</td> </tr> </tbody> </table>		Characteristics		Change from the value before test	Class 1	C0G NP0	±2.5% or ±0.25pF, whichever larger.	X7R X7S X7T X8R X8L	±7.5 %	
			Characteristics		Change from the value before test								
		Class 1	C0G NP0		±2.5% or ±0.25pF, whichever larger.								
X7R X7S X7T X8R X8L	±7.5 %												
Q (Class1)	Meet the initial spec.												
D.F. (Class2)	Meet the initial spec.												
12	Solderability		Leads shall be covered by new solder more than 75% of its surface.	<p>Solder : Sn-3.0Ag-0.5Cu Flux : Isopropyl alcohol (JIS K 8839) Rosin (JIS K 5902) 25% solid solution. Solder temp. : 245±3°C Dwell time : 3±0.3s. Dipping : By 1.5~2.0mm from the root of lead.</p>									
13	Resistance to solder heat	External appearance	No defects which may affect performance.	<p>Solder : Sn-3.0Ag-0.5Cu Flux : Isopropyl alcohol (JIS K 8839) Rosin (JIS K 5902) 25% solid solution. Solder temp. : 260±3°C Dwell time : 10±1s. Dipping : By 1.5~2.0mm from the root of lead.</p> <p>Leave the capacitors in ambient condition for Class 1 : 6~24h Class 2 : 24±2h before measurement.</p>									
		Capacitance	<table border="1" style="width: 100%; border-collapse: collapse;"> <thead> <tr> <th colspan="2">Characteristics</th> <th>Change from the value before test</th> </tr> </thead> <tbody> <tr> <td rowspan="2">Class 1</td> <td>C0G NP0</td> <td>±2.5 % or ±0.25pF whichever larger.</td> </tr> <tr> <td>X7R X7S X7T X8R X8L</td> <td>±7.5 %</td> </tr> </tbody> </table>		Characteristics		Change from the value before test	Class 1	C0G NP0	±2.5 % or ±0.25pF whichever larger.	X7R X7S X7T X8R X8L	±7.5 %	
			Characteristics		Change from the value before test								
		Class 1	C0G NP0		±2.5 % or ±0.25pF whichever larger.								
			X7R X7S X7T X8R X8L		±7.5 %								
		Q (Class1)	Meet the initial spec.										
D.F. (Class2)	Meet the initial spec.												
Insulation Resistance	Meet the initial spec.												
Voltage proof (Between termination)	No insulation breakdown or other damage.												

(continued)

No.	Item	Performance	Test or inspection method																	
14	Heat shock	External appearance	No mechanical damage.																	
	Capacitance	<table border="1" data-bbox="515 309 938 656"> <thead> <tr> <th colspan="2">Characteristics</th> <th>Change from the value before test</th> </tr> </thead> <tbody> <tr> <td>Class 1</td> <td>C0G NP0</td> <td rowspan="2">Please contact with our sales representative.</td> </tr> <tr> <td>Class 2</td> <td>X7R X7S X7T X8R X8L</td> </tr> </tbody> </table>	Characteristics		Change from the value before test	Class 1	C0G NP0	Please contact with our sales representative.	Class 2	X7R X7S X7T X8R X8L	<table border="1" data-bbox="1002 309 1465 499"> <thead> <tr> <th>Step</th> <th>Temp.(°C)</th> <th>Time(min.)</th> </tr> </thead> <tbody> <tr> <td>1</td> <td>Min. operating temp.±3</td> <td>30±3</td> </tr> <tr> <td>2</td> <td>Max. operating temp.±2</td> <td>30±3</td> </tr> </tbody> </table> <p>Test cycle : 1,000cycles Transit time : Less than 1min.</p> <p>Leave the capacitors in ambient condition for Class 1 : 6~24h Class 2 : 24±2h before measurement.</p> <p>Solder the capacitors on a P.C.Board shown in Appendix1 before testing.</p>	Step	Temp.(°C)	Time(min.)	1	Min. operating temp.±3	30±3	2	Max. operating temp.±2	30±3
	Characteristics		Change from the value before test																	
	Class 1	C0G NP0	Please contact with our sales representative.																	
	Class 2	X7R X7S X7T X8R X8L																		
Step	Temp.(°C)	Time(min.)																		
1	Min. operating temp.±3	30±3																		
2	Max. operating temp.±2	30±3																		
Q (Class1)	Meet the initial spec.																			
D.F (Class2)	Meet the initial spec.																			
Insulation Resistance	Meet the initial spec.																			
Voltage proof (Between termination)	No insulation breakdown or other damage.																			
15	Moisture Resistance	External appearance	No mechanical damage.																	
	Capacitance	<table border="1" data-bbox="515 1160 938 1440"> <thead> <tr> <th colspan="2">Characteristics</th> <th>Change from the value before test</th> </tr> </thead> <tbody> <tr> <td>Class 1</td> <td>C0G NP0</td> <td rowspan="2">Please contact with our sales representative.</td> </tr> <tr> <td>Class 2</td> <td>X7R X7S X7T X8R X8L</td> </tr> </tbody> </table>	Characteristics		Change from the value before test	Class 1	C0G NP0	Please contact with our sales representative.	Class 2	X7R X7S X7T X8R X8L	<p>Test temp. : 85±2°C Test humidity : 85%RH Applied voltage : Rated voltage Test time : 1,000 +48,0h Charge/discharge current : 50mA or lower</p> <p>Leave the capacitors in ambient condition for Class 1 : 6~24h Class 2 : 24±2h before measurement.</p> <p>Solder the capacitors on a P.C.Board shown in Appendix1 before testing.</p> <p>Initial value setting (only for class 2) Voltage conditioning «After voltage treat the capacitors under testing temperature and voltage for 1 hour,» leave the capacitors in ambient condition for 24±2h before measurement. Use this measurement for initial value.</p>									
	Characteristics		Change from the value before test																	
	Class 1	C0G NP0	Please contact with our sales representative.																	
	Class 2	X7R X7S X7T X8R X8L																		
Q (Class1)	<table border="1" data-bbox="515 1496 938 1664"> <thead> <tr> <th>Capacitance</th> <th>Q</th> </tr> </thead> <tbody> <tr> <td>30pF and over</td> <td>200 min.</td> </tr> <tr> <td>Under 30pF</td> <td>100+10/3×C min.</td> </tr> </tbody> </table> <p>C : Rated capacitance (pF)</p>	Capacitance	Q	30pF and over	200 min.	Under 30pF	100+10/3×C min.													
Capacitance	Q																			
30pF and over	200 min.																			
Under 30pF	100+10/3×C min.																			
D.F. (Class2)	200% of initial spec max.																			
Insulation Resistance	Please contact with our sales representative.																			

(continued)

No.	Item	Performance	Test or inspection method											
16	Life	External appearance	No mechanical damage.											
		Capacitance	<table border="1"> <thead> <tr> <th colspan="2">Characteristics</th> <th>Change from the value before test</th> </tr> </thead> <tbody> <tr> <td>Class 1</td> <td>C0G NP0</td> <td rowspan="5">Please contact with our sales representative.</td> </tr> <tr> <td rowspan="4">Class 2</td> <td>X7R</td> </tr> <tr> <td>X7S</td> </tr> <tr> <td>X7T</td> </tr> <tr> <td>X8R X8L</td> </tr> </tbody> </table>	Characteristics		Change from the value before test	Class 1	C0G NP0	Please contact with our sales representative.	Class 2	X7R	X7S	X7T	X8R X8L
			Characteristics		Change from the value before test									
		Class 1	C0G NP0	Please contact with our sales representative.										
		Class 2	X7R											
X7S														
X7T														
X8R X8L														
Q (Class1)	<table border="1"> <thead> <tr> <th>Capacitance</th> <th>Q</th> </tr> </thead> <tbody> <tr> <td>30pF and over</td> <td>350 min.</td> </tr> <tr> <td>10pF and over under 30pF</td> <td>$275+5/2 \times C$ min.</td> </tr> <tr> <td>Under 10pF</td> <td>$200+10 \times C$ min.</td> </tr> </tbody> </table> <p>C : Rated capacitance (pF)</p>	Capacitance	Q	30pF and over	350 min.	10pF and over under 30pF	$275+5/2 \times C$ min.	Under 10pF	$200+10 \times C$ min.					
	Capacitance	Q												
	30pF and over	350 min.												
	10pF and over under 30pF	$275+5/2 \times C$ min.												
Under 10pF	$200+10 \times C$ min.													
D.F. (Class2)	200% of initial spec max.													
Insulation Resistance	Please contact with our sales representative.													
			<p>Test temp. : Maximum operating temperature$\pm 2^{\circ}\text{C}$</p> <p>Applied voltage : Please contact with our sales representative.</p> <p>Test time : 1,000 +48,0h</p> <p>Charge/discharge current : 50mA or lower</p> <p>Leave the capacitors in ambient condition for Class 1 : 6~24h Class 2 : 24\pm2h before measurement.</p> <p>Solder the capacitors on a P.C.Board shown in Appendix1 before testing.</p> <p>Initial value setting (only for class 2) Voltage conditioning «After voltage treat the capacitors under testing temperature and voltage for 1 hour,» leave the capacitors in ambient condition for 24\pm2h before measurement. Use this measurement for initial value.</p>											

* As for the initial measurement of capacitors (Class2) on number 8, 10, 11, 13, and 14, leave capacitors at 150 - 10,0°C for 1h and measure the value after leaving capacitors for 24 \pm 2h in ambient condition.

Appendix 1

P.C. board

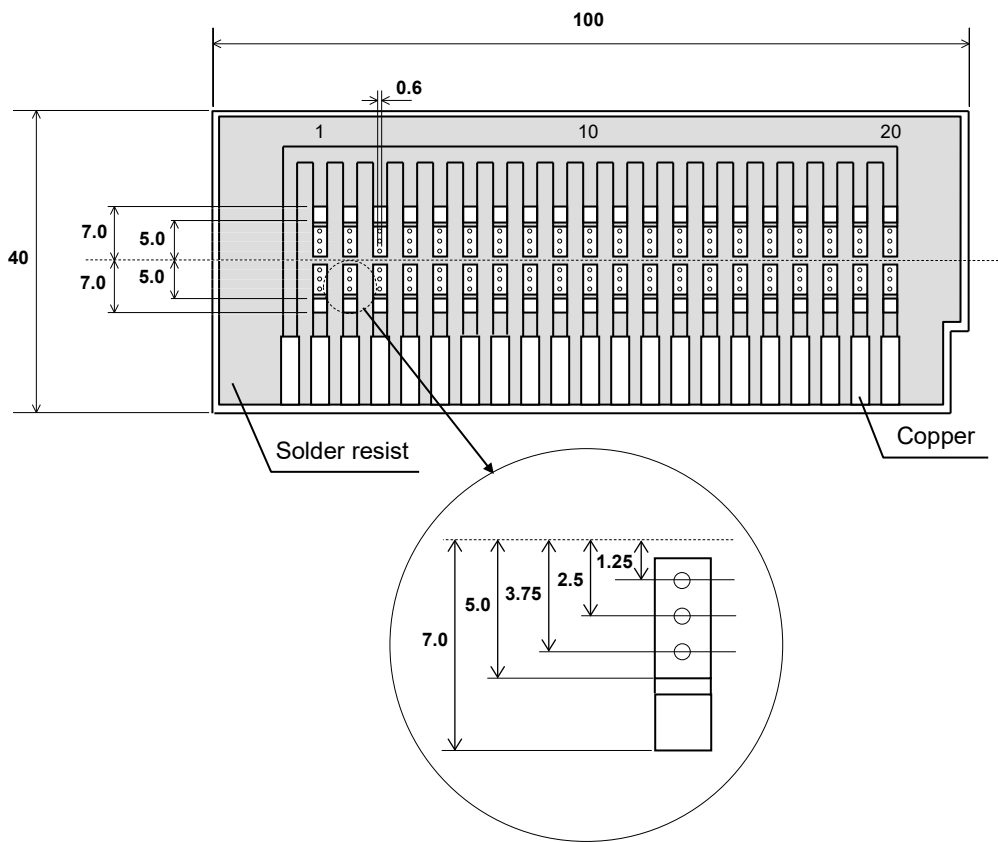

(Unit : mm)

1. Material : Glass Epoxy(As per JIS C6484 GE4)

2. Thickness : 1.6mm

 Copper(Thickness:0.035mm)

 Solder resist

7. INDICATION

7.1 Indication (Example)

Type T.C.	FA18 FA28	FA14 FA24	FA16 FA26	FA11 FA20	FA22	FA23
	C0G	(1) → 333	(1) → 104J (3) ↗	(1) → 104J (3) ↗	(1) → 224J (3) ↗	(1) → 224J (3) ↗
X7R X7S X7T X8R X8L	(1) → 104	(1) → 155K (3) ↗	(1) → 155K (3) ↗	(1) → 335K (3) ↗	(1) → 335K (3) ↗	(1) → 335K (2) ← (3) ↗ (4) ←

7.2 Meaning of indication

No.	Item	Detail
(1)	Rated Capacitance	Indicate in three digits.
(2)	Capacitance tolerance	Indicates the symbol.
(3)	Rated voltage	For DC50V, indicate a bar under the rated capacitance.
(4)	Manufacturer	Indicates " TDK ".

8. INSIDE STRUCTURE AND MATERIAL

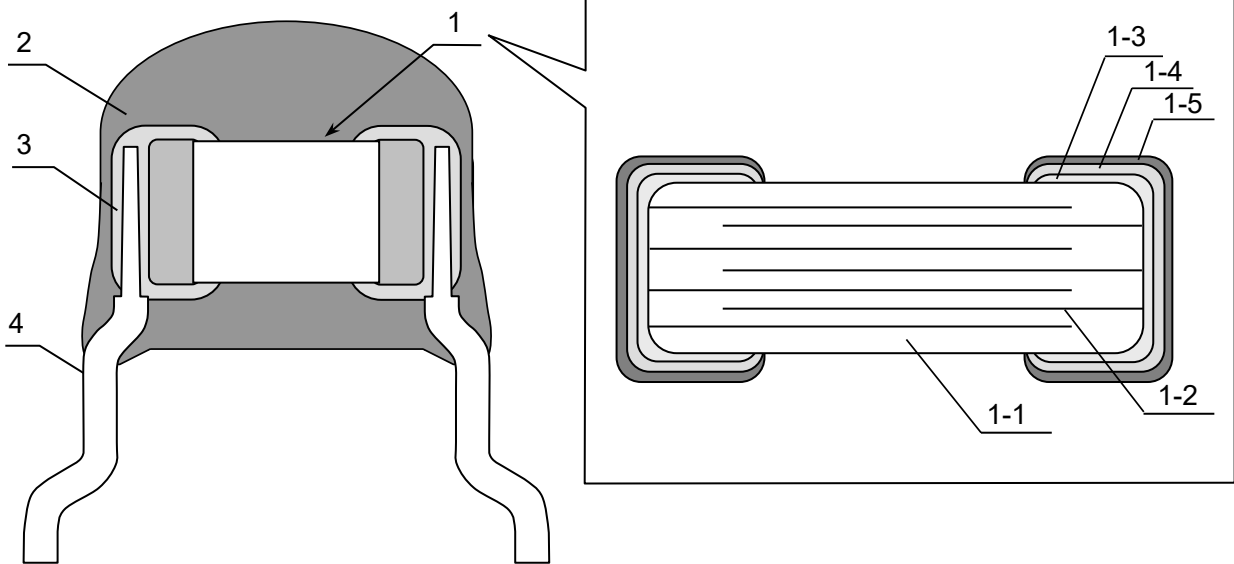

No.	NAME	No.	NAME	MATERIAL	
				Class 1	Class 2
1	Multilayer Ceramic Chip Capacitors	1-1	Dielectric	CaZrO ₃	BaTiO ₃
		1-2	Electrode	Ni	
		1-3	Termination	Cu	
		1-4		Ni	
		1-5		Sn	
2	Coating			Epoxy 【Halogen-free】	
3	Solder for joint			Lead free solder	
4	Lead wire			Tin plated copper covers steel wire	

9. PACKAGING

Packaging shall be done to protect the components from the damage during Transportation and storing, and a label which has the following information shall be attached.

9.1 Each plastic bag for bulk packaging contains 500pcs. And the minimum quantity for Bulk packaging is 500pcs.

*Each plastic bag for FA23 type contains 200pcs. And the minimum quantity for Bulk packaging is 200pcs.

9.2 Tape packaging is as per 11. TAPE PACKAGING SPECIFICATION.

- 1) Inspection No. *
- 2) TDK P/N
- 3) Customer's P/N
- 4) Quantity

* Composition of Inspection No.

Example X 4 A - 23 - 001
 (a) (b) (c) (d) (e)

- a) Inspection factory code
- b) Last digit of year
- c) Month and A for January and B for February and so on. (Skip I)
- d) Inspection Date of the month.
- e) Serial No. of the day

10. CAUTION

No.	Process	Condition
1	Operating Condition (Storage, Use, Transportation)	<p>1-1. Storage, Use</p> <p>The capacitors must be stored in an ambient temperature of 5 to 40°C with a relative humidity of 20 to 70%RH. JIS C 60721-3-1 Class 1K2 should be followed for the other climatic conditions.</p> <ol style="list-style-type: none"> 1) High temperature and humidity environment may affect a capacitor's solder ability because it accelerates Lead wire oxidization. They also deteriorate performance of taping and packaging. Therefore, SMD capacitors shall be used within 6 months. 2) When capacitors are stored for a longer time period than 6 months, confirm the solderability of the capacitors prior to use. During storage, keep the minimum packaging unit in its original packaging without opening it. Do not deviate from the above temperature and humidity conditions even for a short term. 3) Corrosive gasses in the air or atmosphere may result in deterioration of the reliability, such as poor solderability of the Lead wire. Do not store capacitors where they will be exposed to corrosive gas (e.g., hydrogen sulfide, sulfur dioxide, chlorine ammonia etc.) 4) Solderability and electrical performance may deteriorate due to photochemical change in the Lead wire if stored in direct sunlight, or due to condensation from rapid changes in humidity. The capacitors especially which use resin material must be operated and stored in an environment free of dew condensation, as moisture absorption due to condensation may affect the performance. 5) Refer to JIS C 60721-3-1, class 1K2 for other climate conditions. <p>1-2. Handling in transportation</p> <ol style="list-style-type: none"> 1) In case of the transportation of the capacitors, the performance of the capacitors may be deteriorated depending on the transportation condition. (Refer to JEITA RCR-2335C 9.2 Handling in transportation)
2	Circuit design  Caution	<p>2-1. Operating temperature</p> <ol style="list-style-type: none"> 1) Upper category temperature (maximum operating temperature) is specified. It is necessary to select a capacitor whose rated temperature is higher than the operating temperature. Also, it is necessary to consider the temperature distribution in the equipment and seasonal temperature variation. 2) Surface temperature including self heating should be below maximum operating temperature. Due to dielectric loss, capacitors will heat itself when AC is applied due to ESR. Especially at high frequencies, please be careful that the heat might be so extreme. Also, even if the surface temperature of the capacitor includes self-heating and is the maximum operating temperature or lower, excessive heating of the capacitor due to self-heating may cause deterioration of the characteristics and reliability of the capacitor. The self-heating temperature rise of the capacitor changes depending on the difference in heat radiation due to the mounting method to the device, the ambient temperature, the cooling method of the device and circuit board material and the design, etc. The load should be contained so that the self-heating temperature rise of the capacitor body in a natural convection environment at an ambient temperature of 25°C remain below 20°C. When using in a high-frequency circuit or a circuit in which a capacitor generates heat, such as when a high-frequency ripple current flows, pay attention to the above precautions. (Note that accurate measurement may not be possible with self-heating measurement when the equipment applies cooling other than natural convection such as a cooling fan.) 3) The electrical characteristics of the capacitors will vary depending on the temperature. The capacitors should be selected and designed in taking the temperature into consideration.

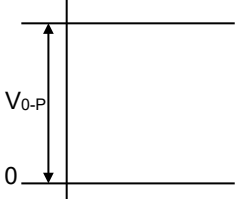
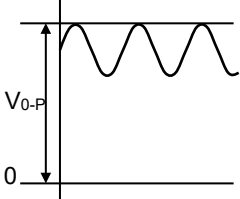
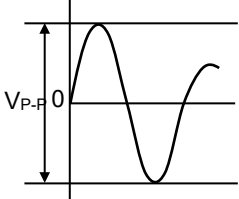
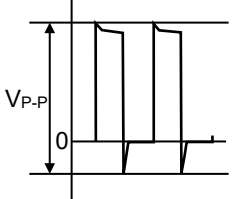
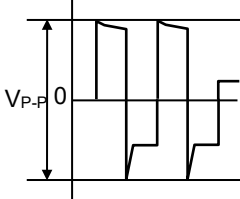
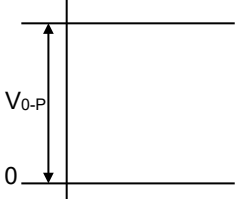
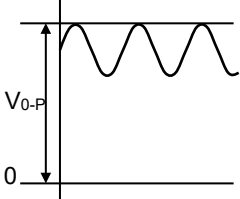
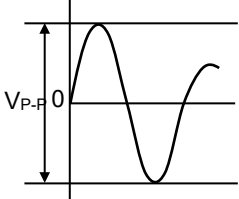
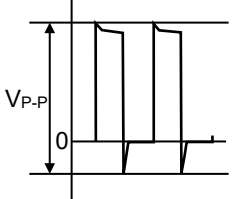
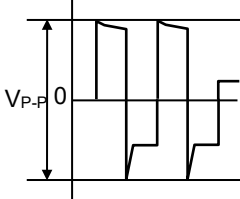
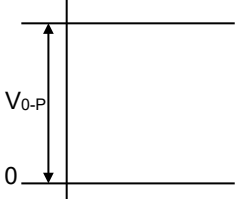
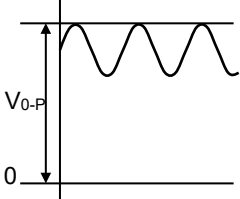
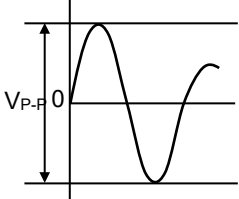
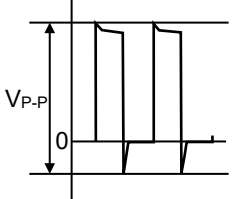
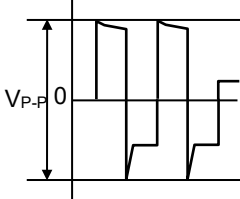
No.	Process	Condition														
2	Circuit design  Caution	<p>2-2. When overvoltage is applied Applying overvoltage to a capacitor may cause dielectric breakdown and result in a short circuit. The duration until dielectric breakdown depends on the applied voltage and the ambient temperature.</p> <p>2-3. Operating voltage</p> <p>1) Operating voltage across the terminals should be below the rated voltage. When AC and DC are super imposed, V_{0-P} must be below the rated voltage. _____ (1) and (2) AC or pulse with overshooting, V_{P-P} must be below the rated voltage. _____ (3), (4) and (5)</p> <p>When the voltage is started to apply to the circuit or it is stopped applying, the irregular voltage may be generated for a transit period because of resonance or switching. Be sure to use a capacitor within rated voltage containing these irregular voltage.</p> <table border="1" data-bbox="435 696 1441 1223"> <thead> <tr> <th data-bbox="435 696 643 730">Voltage</th> <th data-bbox="643 696 908 730">(1) DC voltage</th> <th data-bbox="908 696 1173 730">(2) DC + AC voltage</th> <th data-bbox="1173 696 1441 730">(3) AC voltage</th> </tr> </thead> <tbody> <tr> <td data-bbox="435 730 643 949">Positional Measurement (Rated voltage)</td> <td data-bbox="643 730 908 949">  </td> <td data-bbox="908 730 1173 949">  </td> <td data-bbox="1173 730 1441 949">  </td> </tr> <tr> <th data-bbox="435 972 643 1005">Voltage</th> <th data-bbox="643 972 908 1005">(4) Pulse voltage (A)</th> <th data-bbox="908 972 1173 1005">(5) Pulse voltage (B)</th> </tr> <tr> <td data-bbox="435 1005 643 1223">Positional Measurement (Rated voltage)</td> <td data-bbox="643 1005 908 1223">  </td> <td data-bbox="908 1005 1173 1223">  </td> </tr> </tbody> </table> <p>2) Even below the rated voltage, if repetitive high frequency AC or pulse is applied, the reliability of the capacitors may be reduced.</p> <p>3) The effective capacitance will vary depending on applied DC and AC voltages. The capacitors should be selected and designed in taking the voltages into consideration.</p> <p>4) Abnormal voltage (surge voltage, static electricity, pulse voltage, etc.) shall not exceed the rated voltage.</p> <p>5) When capacitors are used in a series connection, it is necessary to add a balancing circuit such as voltage dividing resistors in order to avoid an imbalance in the voltage applied to each capacitor.</p> <p>2-4. Frequency When the capacitors (Class 2) are used in AC and/or pulse voltages, the capacitors may vibrate themselves and generate audible sound.</p>	Voltage	(1) DC voltage	(2) DC + AC voltage	(3) AC voltage	Positional Measurement (Rated voltage)				Voltage	(4) Pulse voltage (A)	(5) Pulse voltage (B)	Positional Measurement (Rated voltage)		
Voltage	(1) DC voltage	(2) DC + AC voltage	(3) AC voltage													
Positional Measurement (Rated voltage)																
Voltage	(4) Pulse voltage (A)	(5) Pulse voltage (B)														
Positional Measurement (Rated voltage)																

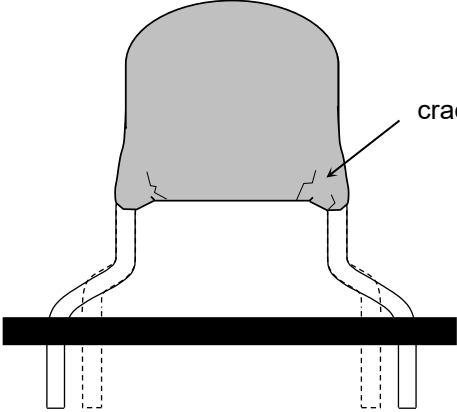
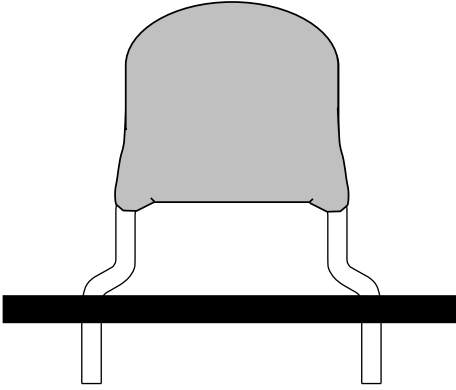
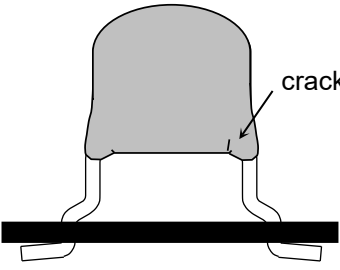
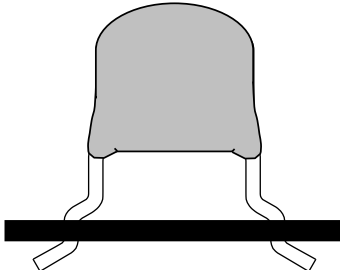
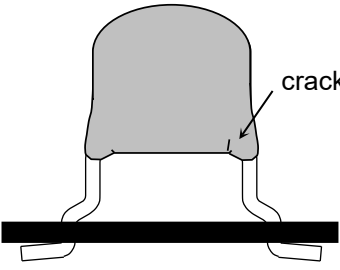
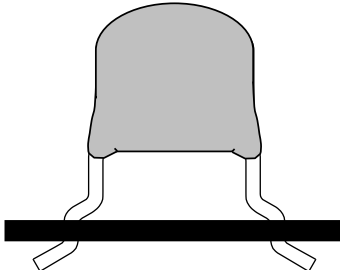
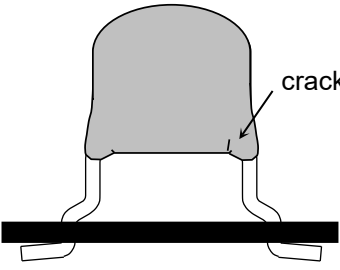
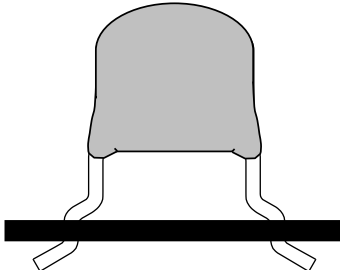
No.	Process	Condition						
3	Designing P.C.board	<p>If capacitor leads are inserted into different pitch holes, it may induce excessive stress in the capacitor or outer resin to result in cracking, and it may degrade the quality. Recommend capacitor layout is as following.</p> <div style="display: flex; justify-content: space-around; align-items: center;"> <div style="text-align: center;"> <p>Not recommended</p>  </div> <div style="text-align: center;"> <p>Recommended</p>  </div> </div>						
4	Lead wire insertion	<p>1) If the leads clinching is too tight, the lead wire tend to be pulled excessively to cause lead wire breakage or cracking of the coating and quality degradation. Please adjust the clinching and provide sufficient preventive maintenance. Recommended capacitor layout is as following.</p> <table border="1" style="width: 100%; border-collapse: collapse;"> <thead> <tr> <th style="width: 30%;"></th> <th style="width: 35%; text-align: center;">Not recommended</th> <th style="width: 35%; text-align: center;">Recommended</th> </tr> </thead> <tbody> <tr> <td style="vertical-align: middle; text-align: center;">Clinching</td> <td style="text-align: center;">  </td> <td style="text-align: center;">  </td> </tr> </tbody> </table> <p>2) If capacitor leads are inserted into different pitch holes, it may induce excessive stress in the capacitor or outer resin to result in cracking, and it may degrade the quality. When the lead pitch does not fit with the through hole on the pc board, please adjust the lead pitch so that the capacitor body would not receive excessive force.</p>		Not recommended	Recommended	Clinching		
	Not recommended	Recommended						
Clinching								

No.	Process	Condition						
5	Soldering	<p>5-1. Flux selection Although highly-activated flux gives better solderability, substances which increase activity may also degrade the insulation of the capacitors. To avoid such degradation, it is recommended following.</p> <ol style="list-style-type: none"> 1) It is recommended to use a mildly activated rosin flux (less than 0.1wt% chlorine). Do not use acidic flux is not recommended. 2) Excessive flux must be avoided. Please provide proper amount of flux. 3) When water-soluble flux is used, enough washing is necessary. <p>5-2. Recommended soldering profile by various methods</p> <div style="display: flex; justify-content: space-around;"> <div data-bbox="347 660 853 1108"> <p style="text-align: center;">Flow soldering</p> </div> <div data-bbox="877 660 1460 1075"> <p style="text-align: center;">Manual soldering (Solder iron)</p> </div> </div> <p>5-3. Avoiding thermal shock</p> <ol style="list-style-type: none"> 1) Preheating condition <table border="1" data-bbox="534 1198 1085 1332" style="margin-left: auto; margin-right: auto;"> <thead> <tr> <th>Soldering</th> <th>Temp.(°C)</th> </tr> </thead> <tbody> <tr> <td>Wave soldering</td> <td>$\Delta T \leq 150$</td> </tr> <tr> <td>Manual soldering</td> <td>$\Delta T \leq 150$</td> </tr> </tbody> </table> <ol style="list-style-type: none"> 2) Cooling condition Natural cooling using air is recommended. If the capacitors are dipped into a solvent for cleaning, the temperature difference(ΔT) must be less than 100°C. <p>5-4. Amount of solder In sufficient solder may detach the capacitor from the P.C.board. See below for example of solder amount.</p> <div style="display: flex; justify-content: space-around; align-items: center;"> <div data-bbox="486 1680 614 1713" style="text-align: center;">Adequate</div> <div data-bbox="742 1624 1013 1780" style="text-align: center;"> </div> </div> <hr/> <div style="display: flex; justify-content: space-around; align-items: center;"> <div data-bbox="486 1825 614 1892" style="text-align: center;">Insufficient solder</div> <div data-bbox="742 1792 1013 1937" style="text-align: center;"> </div> <div data-bbox="1109 1803 1396 1926" style="text-align: center;"> <p>Low robustness may cause contact failure or capacitor comes off the P.C.board.</p> </div> </div>	Soldering	Temp.(°C)	Wave soldering	$\Delta T \leq 150$	Manual soldering	$\Delta T \leq 150$
Soldering	Temp.(°C)							
Wave soldering	$\Delta T \leq 150$							
Manual soldering	$\Delta T \leq 150$							

No.	Process	Condition								
5	Soldering	<p>5-5. Solder repair by solder iron Tip temperature of solder iron varies by its type, P.C.board material and solder land size. Higher the tip temperature, quick the operation is, but the heat shock may crack the capacitor. Following condition is recommended.</p> <p style="text-align: center;">(Recommended solder iron condition)</p> <table border="1" style="width: 100%; border-collapse: collapse;"> <thead> <tr> <th data-bbox="464 394 687 439">Temp. (°C)</th> <th data-bbox="687 394 911 439">Wattage (W)</th> <th data-bbox="911 394 1134 439">Shape (mm)</th> <th data-bbox="1134 394 1358 439">Time (sec.)</th> </tr> </thead> <tbody> <tr> <td data-bbox="464 439 687 506">350 MAX.</td> <td data-bbox="687 439 911 506">20 MAX.</td> <td data-bbox="911 439 1134 506">φ3.0 MAX.</td> <td data-bbox="1134 439 1358 506">3 MAX.</td> </tr> </tbody> </table>	Temp. (°C)	Wattage (W)	Shape (mm)	Time (sec.)	350 MAX.	20 MAX.	φ3.0 MAX.	3 MAX.
Temp. (°C)	Wattage (W)	Shape (mm)	Time (sec.)							
350 MAX.	20 MAX.	φ3.0 MAX.	3 MAX.							
6	Cleaning	<p>1) If an unsuitable cleaning fluid is used, flux residue or some foreign articles may stick to capacitor surface to deteriorate especially the insulation resistance.</p> <p>2) If cleaning condition is not suitable, it may damage the capacitor.</p> <p>2)-1. Insufficient washing (1) Terminal electrodes may corrode by Halogen in the flux. (2) Halogen in the flux may adhere on the surface of capacitor, and lower the insulation resistance. (3) Water soluble flux has higher tendency to have above mentioned problems (1) and (2).</p> <p>2)-2. Excessive washing (1) Excessive washing way damage the coating material of coated capacitor and deteriorate it. (2) When ultrasonic cleaning is used, excessively high ultrasonic energy output can affect the adhesion between the ceramic dielectric and the terminal electrodes. To avoid this, following is the recommended condition.</p> <p style="text-align: center;">Power : 20W/ℓ max. Frequency : 40kHz max. Washing time : 5 minutes max.</p> <p>2)-3. If the cleaning fluid is contaminated, density of Halogen increases, and it may bring the same result as insufficient cleaning.</p>								
7	Coating and molding of the P.C.board	<p>1) When the P.C.board is coated, please verify the quality influence on the product.</p> <p>2) Please verify carefully that there is no harmful decomposing or reaction gas emission during curing which may damage the capacitor.</p> <p>3) Please verify the curing temperature.</p>								

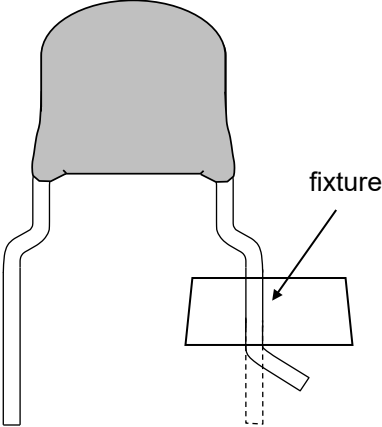
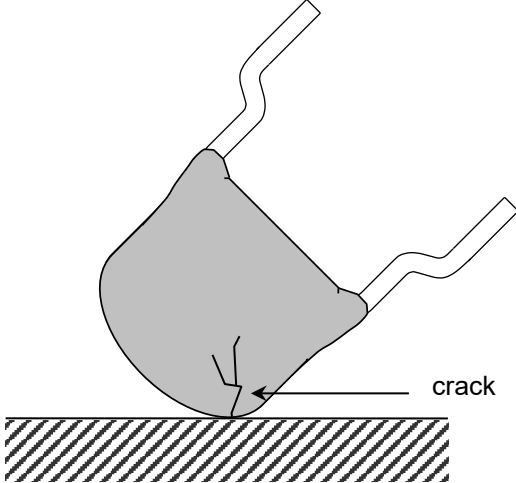
No.	Process	Condition
8	Lead wire bending	<p>During lead wire bending process, mechanical stress often concentrates in one part of capacitor body and it may damage the ceramic and the coating. Refer to following for bending the lead wire.</p>  <p>When bending the lead wire, hold the wire closer to the capacitor with a fixture so that the lead bending would not affect the capacitor body.</p>
9	Handling of loose capacitor	<p>If dropped the capacitor may crack. Once dropped do not use it. Especially, the large case sized capacitor is tendency to have cracks easily, so please handle with care.</p> 
10	Capacitance aging	<p>The capacitors (Class 2) have aging in the capacitance. They may not be used in precision time constant circuit. In case of the time constant circuit, the evaluation should be done well.</p>
11	Estimated life and estimated failure rate of capacitors	<p>The estimated life and the estimated failure rate depend on the temperature and the voltage. This can be calculated by the equation described in JEITA RCR-2335C Annex F(Informative) Calculation of the estimated lifetime and the estimated failure rate (Temperature acceleration : 3rd powered law, Voltage acceleration : 10degC law) The failure rate can be decreased by reducing the temperature and the voltage but they will not be guaranteed.</p>

No.	Process	Condition
12	Caution during operation of equipment	<p>1) A capacitor shall not be touched directly with bare hands during operation in order to avoid electric shock. Electric energy held by the capacitor may be discharged through the human body when touched with a bare hand. Even when the equipment is off, a capacitor may stay charged. The capacitor should be handled after being completely discharged using a resistor.</p> <p>2) The terminals of a capacitor shall not be short-circuited by any accidental contact with a conductive object. A capacitor shall not be exposed to a conductive liquid such as an acid or alkali solution. A conductive object or liquid, such as acid and alkali, between the terminals may lead to the breakdown of a capacitor due to short circuit</p> <p>3) Confirm that the environment to which the equipment will be exposed during transportation and operation meets the specified conditions. Do not to use the equipment in the following environments.</p> <p>(1) Environment where a capacitor is spattered with water or oil (2) Environment where a capacitor is exposed to direct sunlight (3) Environment where a capacitor is exposed to Ozone, ultraviolet rays or radiation (4) Environment where a capacitor exposed to corrosive gas(e.g. hydrogen sulfide, sulfur dioxide, chlorine. ammonia gas etc.) (5) Environment where a capacitor exposed to vibration or mechanical shock exceeding the specified limits. (6) Atmosphere change with causes condensation</p>
13	Others  Caution	<p>The product listed in this specification is intended for use in automotive applications under-normal operation and usage conditions.</p> <p>The product is not designed or warranted to meet the requirements of the applications listed below, whose performance and/or quality requires a more stringent level of safety or reliability, or whose failure, malfunction or defect could cause serious damage to society, person or property. Please understand that we are not responsible for any damage or liability caused by use of the products in any of the applications below or for any other use exceeding the range or conditions set forth in this specification sheet. If you intend to use the products in the applications listed below or if you have special requirements exceeding the range or conditions set forth in this specification, please contact us.</p> <p>(1) Aerospace/Aviation equipment (2) Transportation equipment (electric trains, ships etc.) (3) Medical equipment (Excepting Pharmaceutical Affairs Law classification Class1,2) (4) Power-generation control equipment (5) Atomic energy-related equipment (6) Seabed equipment (7) Transportation control equipment (8) Public information-processing equipment (9) Military equipment (10) Electric heating apparatus, burning equipment (11) Disaster prevention/crime prevention equipment (12) Safety equipment (13) Other applications that are not considered general-purpose applications</p> <p>When designing your equipment even for general-purpose applications, you are kindly requested to take into consideration securing protection circuit/device or providing backup circuits in your equipment.</p> <p>In addition, although the product listed in this specification is intended for use in automotive applications as described above, it is not prohibited to use in general electronic equipment, whose performance and/or quality doesn't require a more stringent level of safety or reliability, or whose failure, malfunction or defect could not cause serious damage to society, person or property.</p> <p>Therefore, the description of this caution will be applied, when the products are used in general electronic equipment under a normal operation and usage conditions.</p>

11.TAPE PACKAGING SPECIFICATION

1. DIMENSION OF TAPING

Dimensions of FA1* type shall be according to Appendix 2.

Dimensions of FA2* type shall be according to Appendix 3.

2. QUANTITY

Type	Parts quantity/box (pcs.)
FA18, FA28 FA14, FA24 FA16, FA26	2,000
FA11, FA20	1,500
FA22, FA23	1,000

3. PERFORMANCE SPECIFICATIONS

- 3-1. The missing of components shall be within consecutive 3pcs.
- 3-2. Empty part for min 3pcs shall be provided at the beginning and the end of taping.
- 3-3. Shipping label must be attached at the side of carton.
- 3-4. When pull the carrier tape for left side with keeping the head of capacitors to the direction of the above figure, adhesive tape shall be upper side.
- 3-5. Folded tape shall contain 25pcs. of components.

4. PACKAGING SPECIFICATION (Ammo pack)

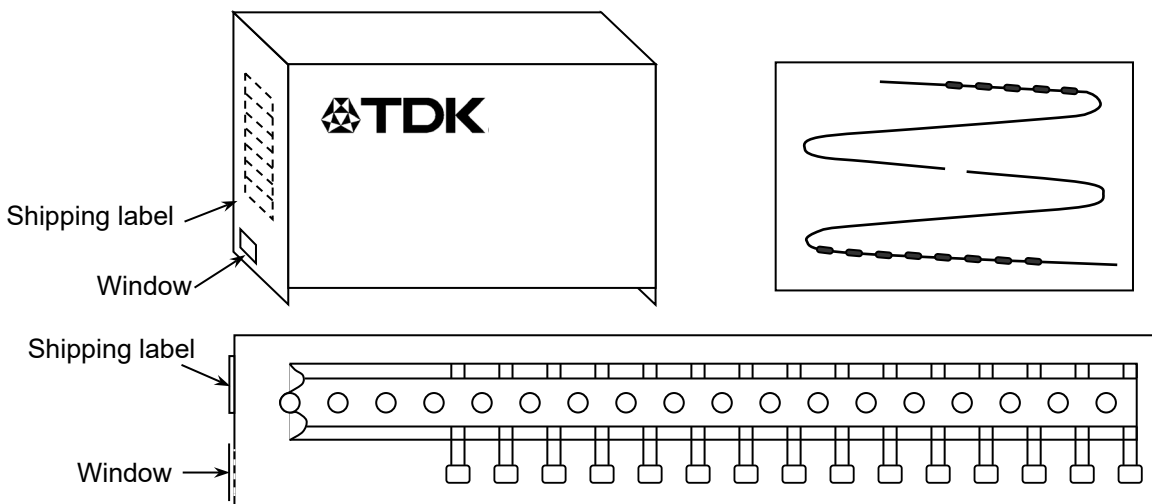

- 4-1. Head of the capacitors shall face the window.
- 4-2. In case of FA22 and FA23 series, a stainless round steel is put in a hole of tape. Please remove a stainless round steel at the time of use.

Appendix 2

Taping dimensions

(FA18,FA14,FA16,FA11)

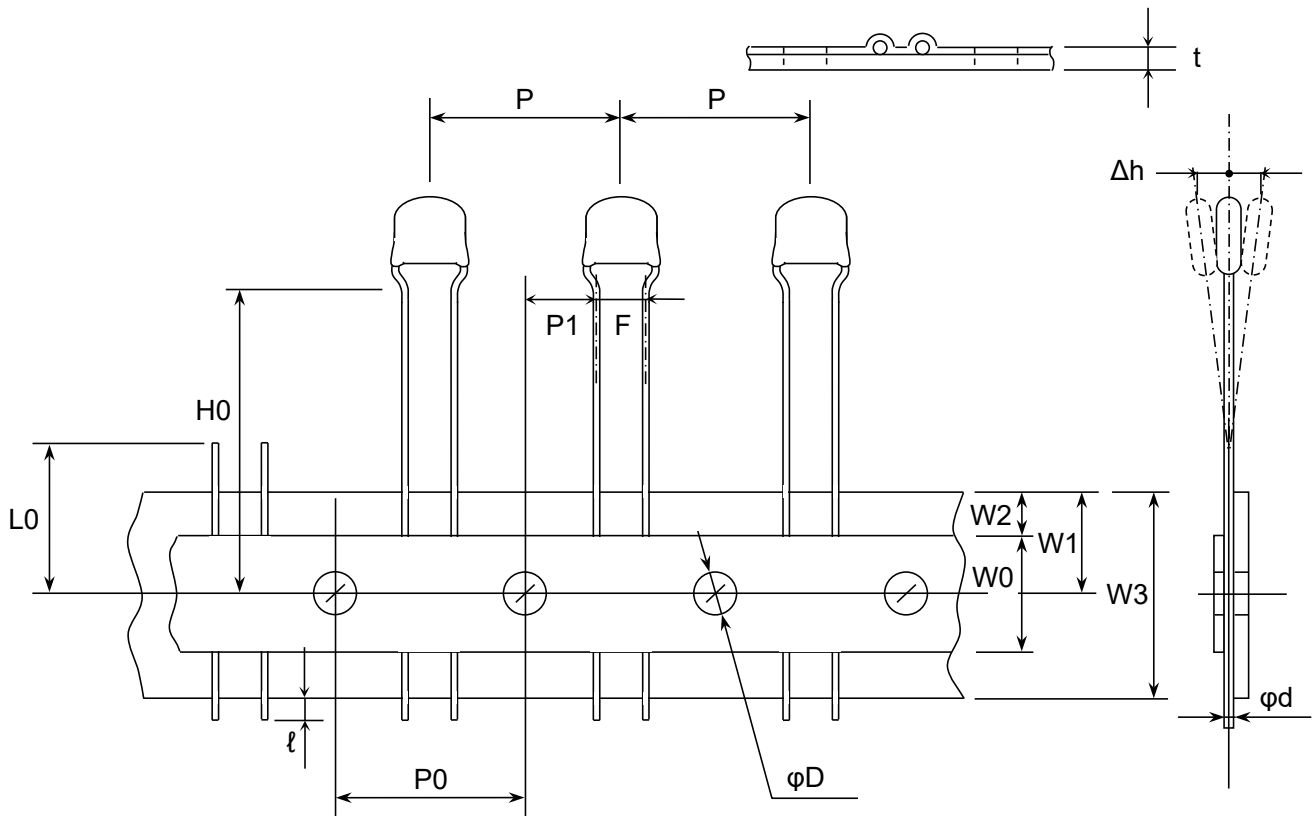

(Unit : mm)

Symbol	Dimensions	Note
P	(12.7)	
P0	(12.7)	
P1	(5.1)	
W0	12.0±1.0	
W1	9.0±0.5	
W2	3.0 max.	Adhesive tape shall not stick out from carrier tape.
W3	18.0+1.0,-0.5	
H0	16.0±0.8	
ℓ	1.0 max.	
t	0.6±0.2	
L0	11.0 max.	
F	2.5+0.5,-0.2	The measurement point is 1.5 to 2.0mm below the kink.
φd	φ0.5+0.1,-0.03	
φD	(φ4.0)	
Δh	(±2)	

() Reference value.

Appendix 3

Taping dimensions (FA28,FA24,FA26,FA20,FA22,FA23)

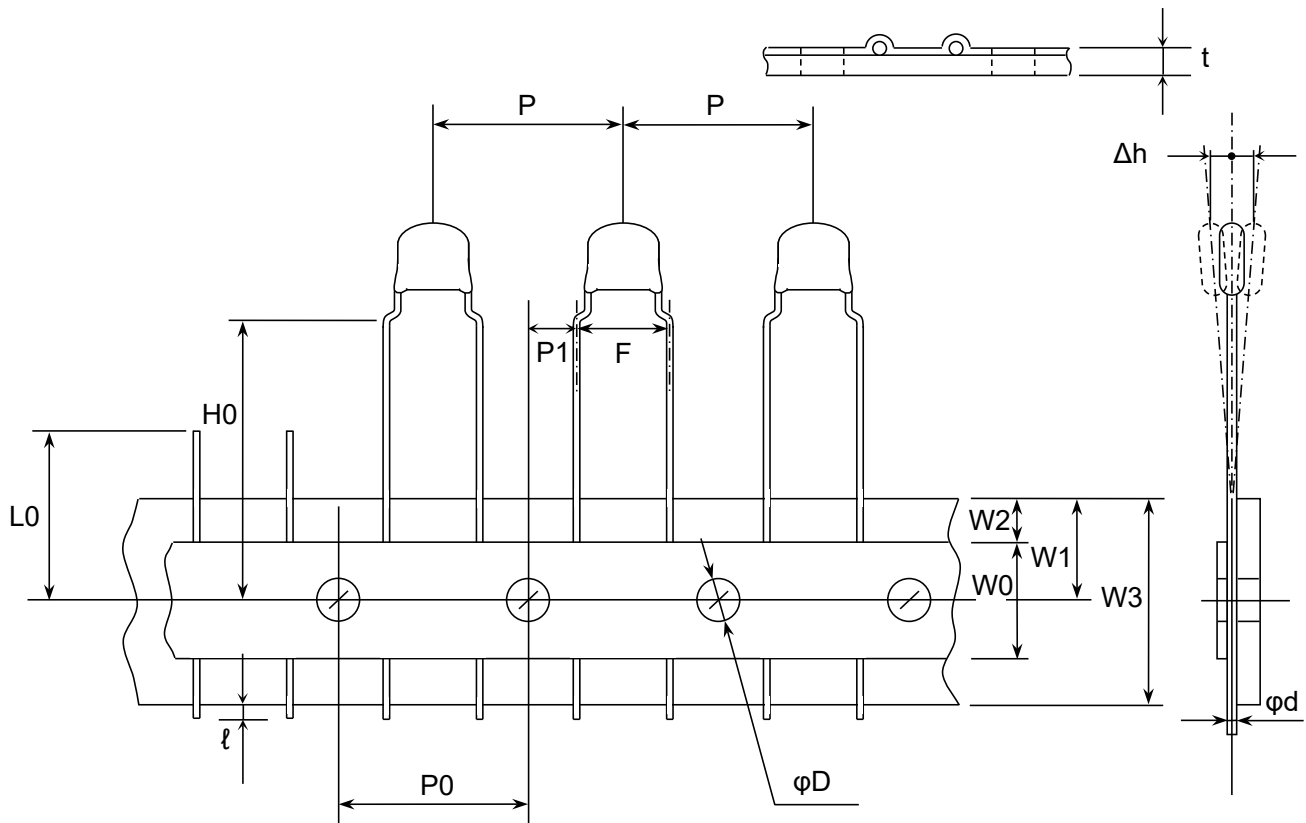

(Unit : mm)

Symbol	Dimensions	Note
P	(12.7)	
P0	(12.7)	
P1	(3.85)	
W0	12.0±1.0	
W1	9.0±0.5	
W2	3.0 max.	Adhesive tape shall not stick out from carrier tape.
W3	18.0+1.0,-0.5	
H0	16.0±0.8	
ℓ	1.0 max.	
t	0.6±0.2	
L0	11.0 max.	
F	5.0+0.8,-0.2	The measurement point is 1.5 to 2.0mm below the kink.
φd	φ0.5+0.1,-0.03	
φD	(φ4.0)	
Δh	(±2)	

() Reference value.