

- 注記
NOTES
- 材質
ハウジング：耐熱性ナイロンUL94V-0
ピン：銅合金、ニッケル下地、錫メッキ、金メッキ
フィッティングネール：銅合金、ニッケル下地、錫メッキ
MATERIAL
HOUSING:POLYAMIDE UL94V-0
PIN: COPPER ALLOY, GOLD OR TIN OVER NICKEL PLATE.
FITTING NAIL: COPPER ALLOY, TIN OVER NICKEL PLATE.
 - 色：ナチュラル、黒、赤、青
COLOR:NATURAL, BLACK, RED, BLUE
 - 嵌合相手
ハウジング：502351-**0*
錫メッキ端子：50212-8*00,50372-8*00,560085-0101
金メッキ端子：56161-8*81
MATES WITH
HOUSING:502351-**0*
SN PLATING TERMINAL:50212-8*00,50372-8*00,560085-0101
AU PLATING TERMINAL:56161-8*81
 - エンボス梱包品の詳細はSD-502352-002参照
DETAILED TAPING PACKAGE, SEE SD-502352-002.
 - ELV及びRoHS適合
ELV AND RoHS COMPLIANT
 - 半田付け面のコプラナリティ：0.1mm MAX.
CO-PLANARITY OF SOLDERING TAILS TO BE 0.1mm MAX.

- 7.一般公差
GENERAL TOLERANCES
10 UNDER: ±0.2
10 OVER 30 UNDER: ±0.25
30 OVER: ±0.3
ANGULAR: ±3°

INITIAL REVISION:
DRWN SHSHIBATA 2007/12/18
CHECK HKOMATSU 2007/12/18
APPR AKANESHIGE 2007/12/18

FUNCTIONAL SYMBOLS DIMENSION UNITS SCALE mm 5:1	THIS DRAWING CONTAINS INFORMATION THAT IS PROPRIETARY TO MOLEX ELECTRONIC TECHNOLOGIES, LLC AND SHOULD NOT BE USED WITHOUT WRITTEN PERMISSION						
	CURRENT REV DESC: For fixing wrong view of 6ckt						
	GENERAL TOLERANCES (UNLESS SPECIFIED) ANGULAR TOL ± 0.5°						
	4 PLACES ±						
DIVISIONAL SYMBOLS	3 PLACES ±	STATUS: Production DRWN: Hideo Yoneyama 2024-05-14 CHK'D: Hiromichi Komatsu 2024-05-16 APPR: Takashi Iida 2024-05-16	DOCUMENT NUMBER SD-502352-001				
	2 PLACES ±			DOC TYPE PSD			
	1 PLACE ±			DOC PART 001			
	0 PLACES ±			REVISION L4			
DRAFT WHERE APPLICABLE MUST REMAIN WITHIN DIMENSIONS		THIRD ANGLE PROJECTION	DRAWING A3-SIZE	SERIES 502352	MATERIAL NUMBER SEE CHART	CUSTOMER GENERAL MARKET	SHEET NUMBER 1 OF 4

molex

2.0MM PITCH W/B CONN.
WAFER ASSY R/A SMT

PRODUCT SALES DRAWING

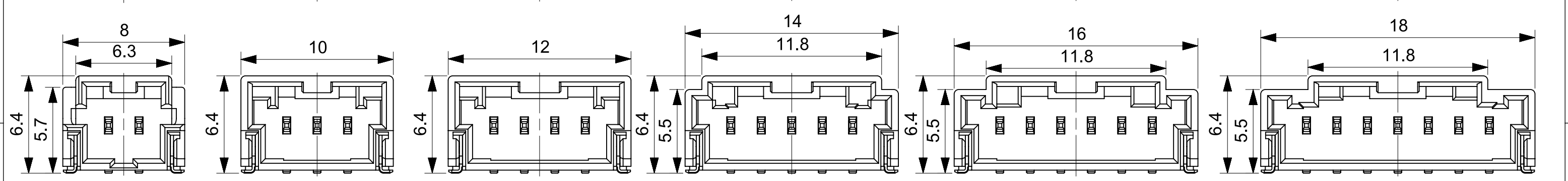
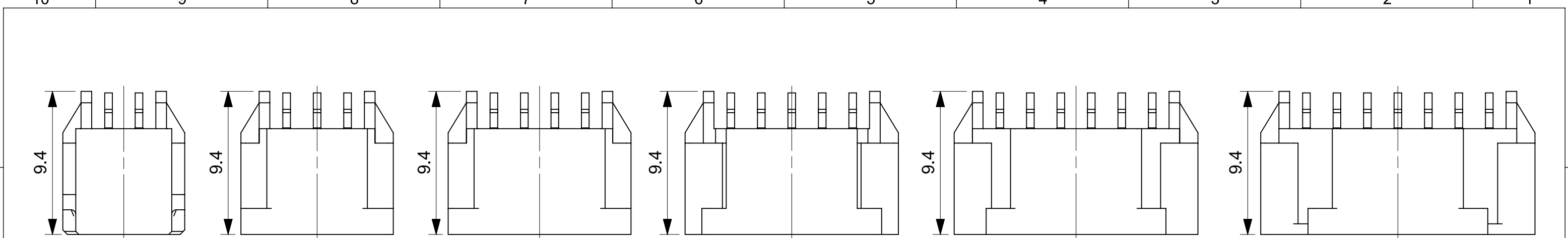

2CKTS

3CKTS

4CKTS

5CKTS

6CKTS

7CKTS

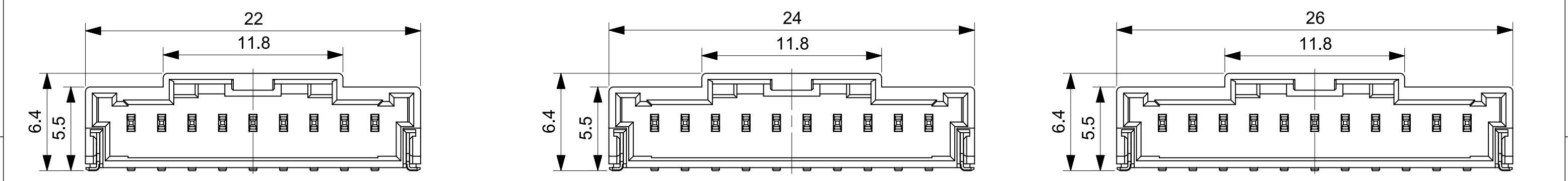
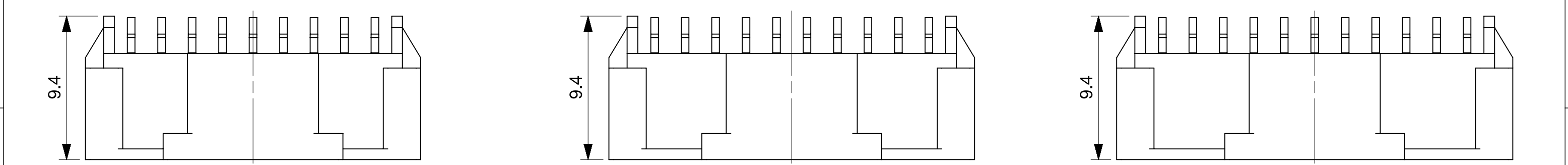

9CKTS

10CKTS

11CKTS

INITIAL REVISION:
 DRWN SHSHIBATA 2007/12/18
 CHECK HKOMATSU 2007/12/18
 APPR AKANESHIGE 2007/12/18

FUNCTIONAL SYMBOLS $\nabla_A = 0$ $\nabla_B = 0$ $\nabla_C = 0$ DIVISIONAL SYMBOLS	THIS DRAWING CONTAINS INFORMATION THAT IS PROPRIETARY TO MOLEX ELECTRONIC TECHNOLOGIES, LLC AND SHOULD NOT BE USED WITHOUT WRITTEN PERMISSION		CURRENT REV DESC: For fixing wrong view of 6ckt	
	DIMENSION UNITS	SCALE		
	mm	4:1		
	GENERAL TOLERANCES (UNLESS SPECIFIED)			
ANGULAR TOL ± 0.5°				
4 PLACES	±	STATUS: Production		
3 PLACES	±	DRWN: Hideo Yoneyama		
2 PLACES	±	CHK'D: Hiromichi Komatsu		
1 PLACE	±	APPR: Takashi Iida		
0 PLACES	±	2024-05-14		
DRAFT WHERE APPLICABLE MUST REMAIN WITHIN DIMENSIONS		THIRD ANGLE PROJECTION	DRAWING	SERIES
			A3-SIZE	502352
		MATERIAL NUMBER	CUSTOMER	SHEET NUMBER
		SEE CHART	GENERAL MARKET	2 OF 4

PRODUCT SALES DRAWING			
DOCUMENT NUMBER	DOC TYPE	DOC PART	REVISION
SD-502352-001	PSD	001	L4

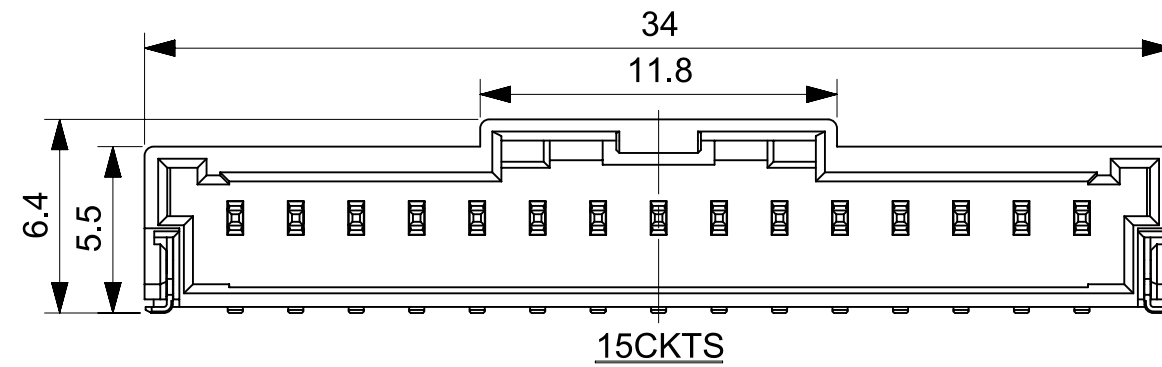
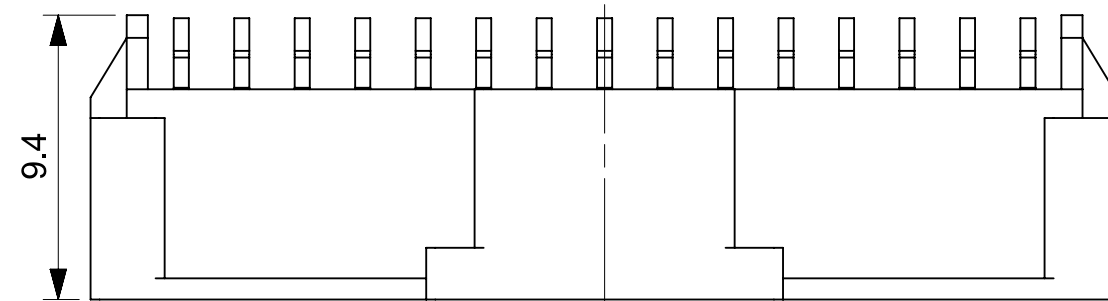
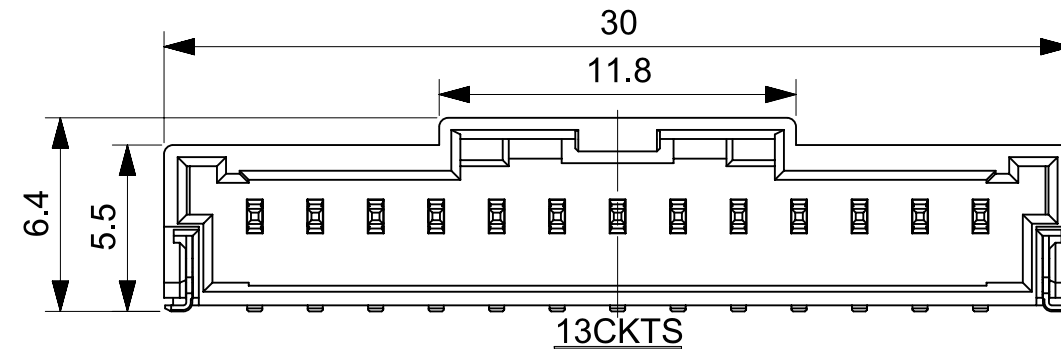
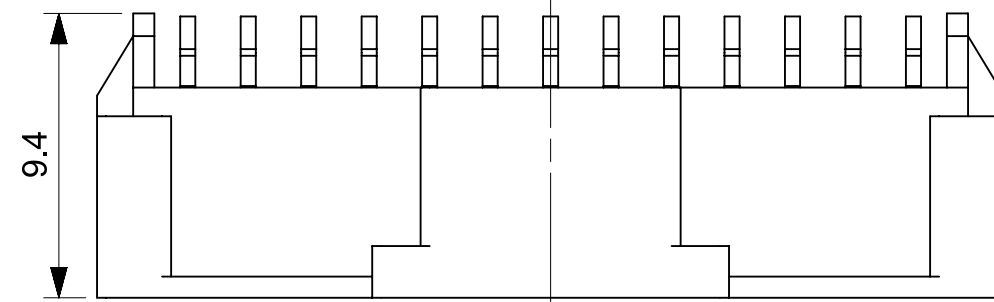
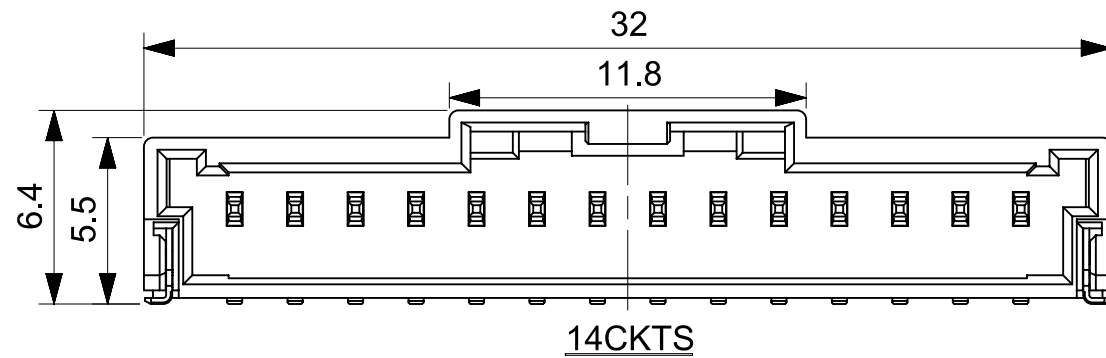
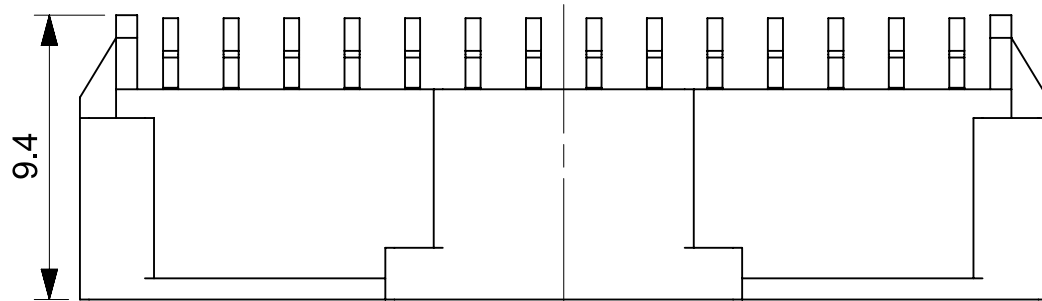
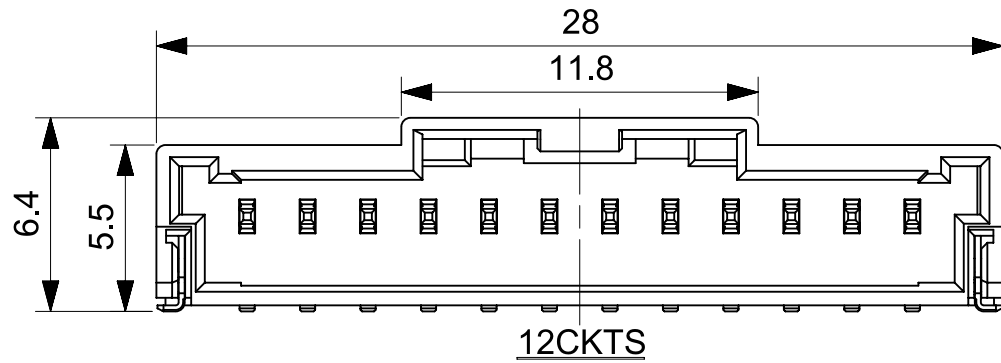
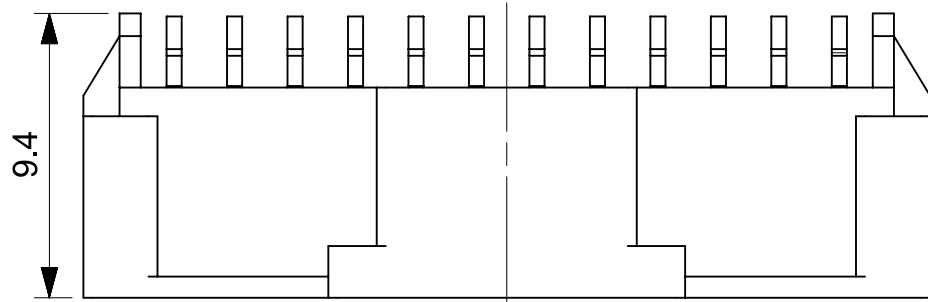

INITIAL REVISION:
 DRWN SHSHIBATA 2007/12/18
 CHECK HKOMATSU 2007/12/18
 APPR AKANESHIGE 2007/12/18

FUNCTIONAL SYMBOLS $\nabla/A = 0$ $\nabla/B = 0$ $\nabla/C = 0$ DIVISIONAL SYMBOLS	THIS DRAWING CONTAINS INFORMATION THAT IS PROPRIETARY TO MOLEX ELECTRONIC TECHNOLOGIES, LLC AND SHOULD NOT BE USED WITHOUT WRITTEN PERMISSION CURRENT REV DESC: For fixing wrong view of 6ckt	
	DIMENSION UNITS mm	SCALE 4:1
	GENERAL TOLERANCES (UNLESS SPECIFIED) ANGULAR TOL $\pm 0.5^\circ$ 4 PLACES \pm 3 PLACES \pm 2 PLACES \pm 1 PLACE \pm 0 PLACES \pm	
	DRAFT WHERE APPLICABLE MUST REMAIN WITHIN DIMENSIONS THIRD ANGLE PROJECTION 	
STATUS: Production DRWN: Hideo Yoneyama 2024-05-14 CHK'D: Hiromichi Komatsu 2024-05-16 APPR: Takashi Iida 2024-05-16		DOCUMENT NUMBER SD-502352-001
DRAWING A3-SIZE		SERIES 502352
MATERIAL NUMBER SEE CHART		CUSTOMER GENERAL MARKET
SHEET NUMBER 3 OF 4		DOC TYPE DOC PART REVISION PSD 001 L4

molex

2.0MM PITCH W/B CONN.
 WAFER ASSY R/A SMT

PRODUCT SALES DRAWING

Sn NATURAL	34.0	502352-1500	15
	32.0	502352-1400	14
	30.0	502352-1300	13
	28.0	502352-1200	12
	26.0	502352-1100	11
	24.0	502352-1000	10
	22.0	502352-0900	9
	20.0	502352-0800	8
	18.0	502352-0700	7
	16.0	502352-0600	6
	14.0	502352-0500	5
	12.0	502352-0400	4
10.0	502352-0300	3	
8.0	502352-0200	2	
PLATING COLOR	A	EMBOSSSED PACKAGE ORDER NO.	CKTS
CONNECTOR SERIES NO. 502352-**08			

Au NATURAL	34.0	502352-1510	15
	32.0	502352-1410	14
	30.0	502352-1310	13
	28.0	502352-1210	12
	26.0	502352-1110	11
	24.0	502352-1010	10
	22.0	502352-0910	9
	20.0	502352-0810	8
	18.0	502352-0710	7
	16.0	502352-0610	6
	14.0	502352-0510	5
	12.0	502352-0410	4
10.0	502352-0310	3	
8.0	502352-0210	2	
PLATING COLOR	A	EMBOSSSED PACKAGE ORDER NO.	CKTS
CONNECTOR SERIES NO. 502352-**18			

Sn BLACK	34.0	502352-1501	15
	32.0	502352-1401	14
	30.0	502352-1301	13
	28.0	502352-1201	12
	26.0	502352-1101	11
	24.0	502352-1001	10
	22.0	502352-0901	9
	20.0	502352-0801	8
	18.0	502352-0701	7
	16.0	502352-0601	6
	14.0	502352-0501	5
	12.0	502352-0401	4
10.0	502352-0301	3	
8.0	502352-0201	2	
PLATING COLOR	A	EMBOSSSED PACKAGE ORDER NO.	CKTS
CONNECTOR SERIES NO. 502352-**28			

Sn RED	-	-	15
	-	-	14
	-	-	13
	-	-	12
	-	-	11
	-	-	10
	-	-	9
	20.0	502352-0802	8
	-	-	7
	16.0	502352-0602	6
	-	-	5
	12.0	502352-0402	4
10.0	502352-0302	3	
8.0	502352-0202	2	
PLATING COLOR	A	EMBOSSSED PACKAGE ORDER NO.	CKTS
CONNECTOR SERIES NO. 502352-**48			

Sn BLUE	-	-	15
	-	-	14
	-	-	13
	-	-	12
	-	-	11
	-	-	10
	-	-	9
	20.0	502352-0803	8
	-	-	7
	16.0	502352-0603	6
	-	-	5
	12.0	502352-0403	4
10.0	502352-0303	3	
8.0	502352-0203	2	
PLATING COLOR	A	EMBOSSSED PACKAGE ORDER NO.	CKTS
CONNECTOR SERIES NO. 502352-**68			

INITIAL REVISION:
 DRWN SHSHIBATA 2007/12/18
 CHECK HKOMATSU 2007/12/18
 APPR AKANESHIGE 2007/12/18

FUNCTIONAL SYMBOLS				THIS DRAWING CONTAINS INFORMATION THAT IS PROPRIETARY TO MOLEX ELECTRONIC TECHNOLOGIES, LLC AND SHOULD NOT BE USED WITHOUT WRITTEN PERMISSION															
DIMENSION UNITS		SCALE		CURRENT REV DESC: For fixing wrong view of 6ckt															
mm		1:1																	
GENERAL TOLERANCES (UNLESS SPECIFIED)																			
ANGULAR TOL ± 0.5°																			
4 PLACES ±																			
3 PLACES ±																			
2 PLACES ±																			
1 PLACE ±																			
0 PLACES ±																			
DRAFT WHERE APPLICABLE MUST REMAIN WITHIN DIMENSIONS				THIRD ANGLE PROJECTION		DRAWING		SERIES		MATERIAL NUMBER		CUSTOMER		SHEET NUMBER					
						A3-SIZE		502352		SEE CHART		GENERAL MARKET		4 OF 4					
				STATUS: Production															
				DRWN: Hideo Yoneyama				2024-05-14											
				CHK'D: Hiromichi Komatsu				2024-05-16											
				APPR: Takashi Iida				2024-05-16											
								DOCUMENT NUMBER				SD-502352-001		DOC TYPE		DOC PART		REVISION	
												PSD		001		L4			

molex

2.0MM PITCH W/B CONN.
 WAFER ASSY R/A SMT

PRODUCT SALES DRAWING

注記
NOTES

- 製品番号
 ナチュラル・錫めっき: 502352-**00
 ナチュラル・金めっき: 502352-**10
 黒・錫めっき: 502352-**01
 赤・錫めっき: 502352-**02
 青・錫めっき: 502352-**03
 詳細寸法については、製品単体図面を参照下さい。
 PART NO.
 NATURAL Sn Plating: 502352-**00
 NATURAL Au Plating: 502352-**10
 BLACK Sn Plating: 502352-**01
 RED Sn Plating: 502352-**02
 BLUE Sn Plating: 502352-**03
 SEE SALES DRAWING FOR CONNECTOR
- 梱包数量: 700個/リール
 NUMBER OF CONNECTORS 700PCS/REEL
- リードテープ長さ
 LEAD TAPE LENGHT
- 材料
 MATERIAL
 キャリアテープ: ポリスチレン
 CARRIER TAPE: POLYSTYRENE
 トップテープ: PET, PE, PEF
 TOP TAPE: PET, PE, PEF
 リール: ポリスチレン
 REEL: POLYSTYRENE
- 一般公差
 GENERAL TOLERANCES
 10 UNDER: ±0.2
 10 OVER 30 UNDER: ±0.25
 30 OVER: ±0.3
 ANGULAR: ±1°

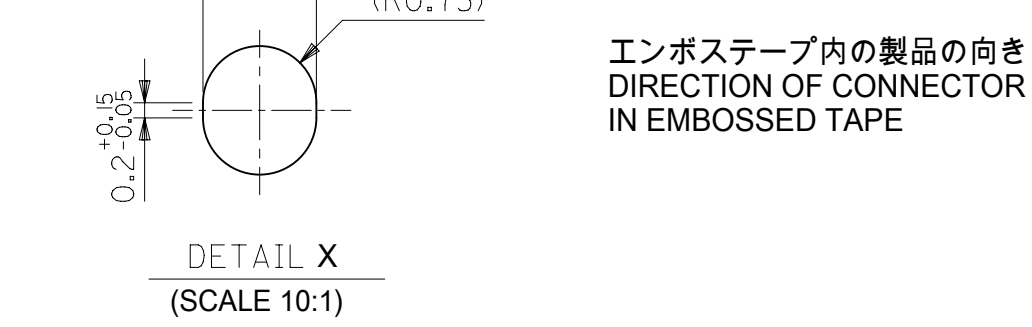
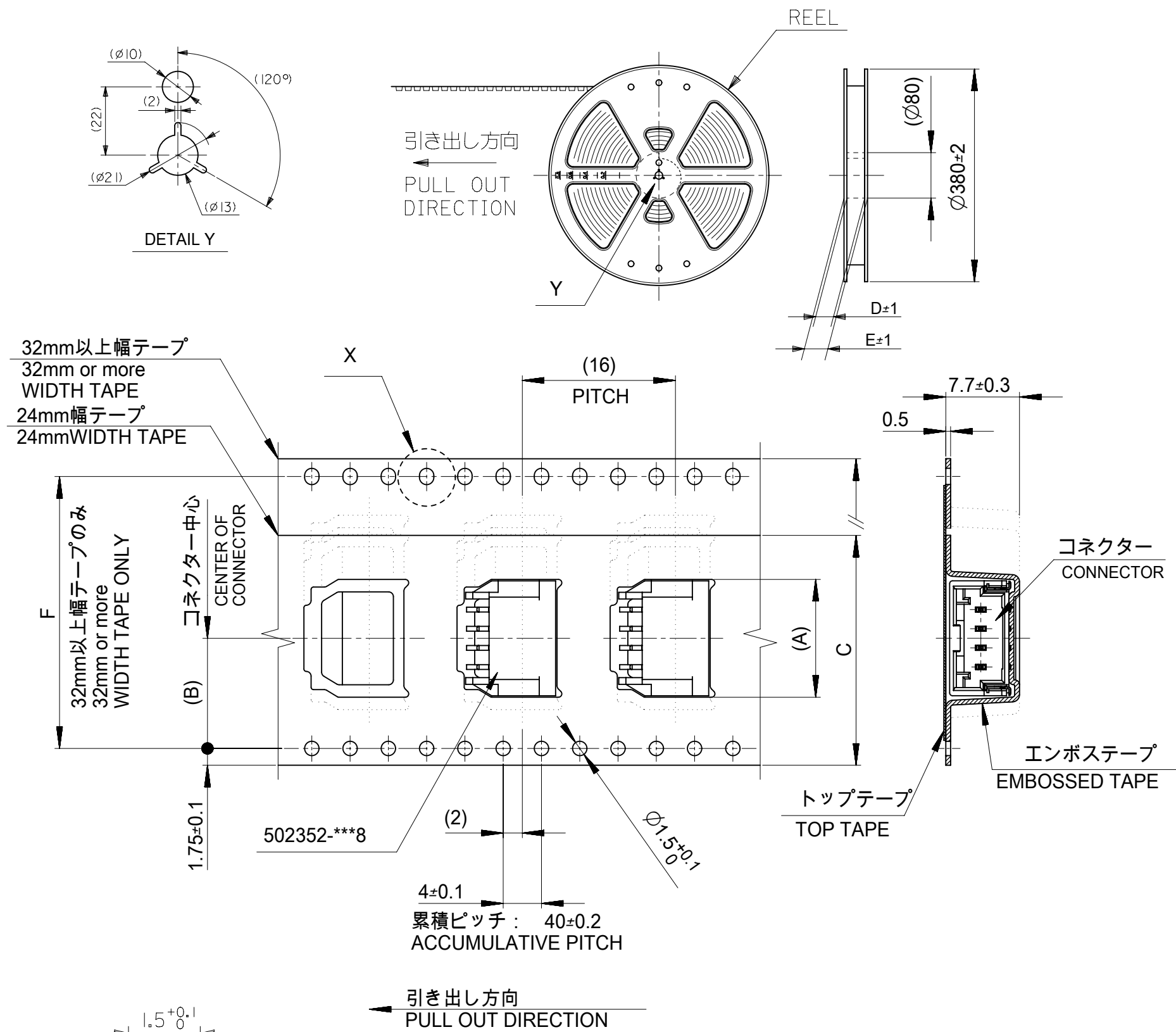
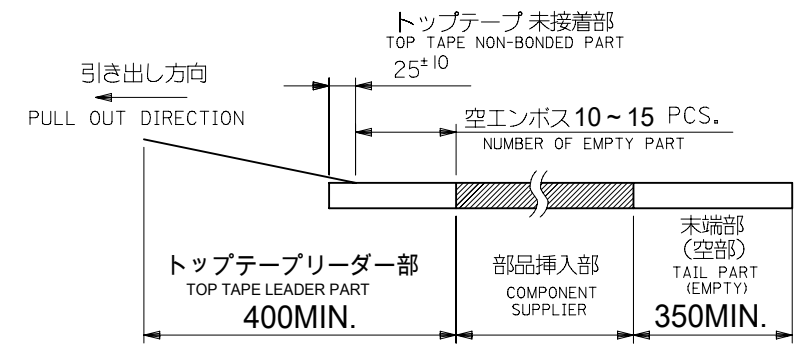

引き出し方向
PULL OUT DIRECTION

エンボステープ内の製品の向き
DIRECTION OF CONNECTOR
IN EMBOSSED TAPE

THIS DRAWING CONTAINS INFORMATION THAT IS PROPRIETARY TO MOLEX ELECTRONIC TECHNOLOGIES, LLC AND SHOULD NOT BE USED WITHOUT WRITTEN PERMISSION		CURRENT REV DESC:		molex	
DIMENSION UNITS	SCALE				
mm	NTS			2.0MM PITCH W/B CONN. WAFFER ASSY EMBOSSED TAPE PACKAGE	
GENERAL TOLERANCES (UNLESS SPECIFIED)		EC NO: 629663		PRODUCT CUSTOMER DRAWING	
ANGULAR TOL	±	DRWN: MSATO08	2019/12/26	DOCUMENT NUMBER	
4 PLACES	±	CHK'D: HIJIMA	2019/12/27	SD-502352-002	
3 PLACES	±	APPR: TOSADA	2019/12/27	DOC TYPE	DOC PART
2 PLACES	±	INITIAL REVISION:		PSD	001
1 PLACE	±	DRWN: SHSHIBATA	2007/06/19	REVISION	
0 PLACES	±	APPR: AKANESHIGE	2007/06/19	K2	
DRAFT WHERE APPLICABLE MUST REMAIN WITHIN DIMENSIONS		THIRD ANGLE PROJECTION	DRAWING	SERIES	MATERIAL NUMBER
			A3-SIZE	502352	CUSTOMER
					GENERAL MARKET
					SHEET NUMBER
					1 OF 2

INITIAL REVISION:

DRWN	SHSHIBATA	2007/06/06
CHECK	TAITO	2007/06/06
APPR	MAYAMAMOTO	2012/03/14

E	Sn NATURAL	52.4	61.4	57.4	56	26.2	34.3	502352-1500	15	Au NATURAL	52.4	61.4	57.4	56	26.2	34.3	502352-1510	15
							32.3	502352-1400	14							32.3	502352-1410	14
		40.4	49.4	45.4	44	20.2	30.3	502352-1300	13		40.4	49.4	45.4	44	20.2	30.3	502352-1310	13
							28.3	502352-1200	12							28.3	502352-1210	12
							26.3	502352-1100	11							26.3	502352-1110	11
							24.3	502352-1000	10							24.3	502352-1010	10
							22.3	502352-0900	9							22.3	502352-0910	9
		28.4	37.4	33.4	32	14.2	20.3	502352-0800	8		28.4	37.4	33.4	32	14.2	20.3	502352-0810	8
							18.3	502352-0700	7							18.3	502352-0710	7
							16.3	502352-0600	6							16.3	502352-0610	6
							14.3	502352-0500	5							14.3	502352-0510	5
							12.3	502352-0400	4							12.3	502352-0410	4
		/	29.4	25.4	24	11.5	10.3	502352-0300	3		/	29.4	25.4	24	11.5	10.3	502352-0310	3
							8.3	502352-0200	2							8.3	502352-0210	2
							PLATING COLOR									F	E	D

C	Sn BLACK	52.4	61.4	57.4	56	26.2	34.3	502352-1501	15	Sn RED	/	/	/	/	/	/	/	15
							32.3	502352-1401	14									14
		40.4	49.4	45.4	44	20.2	30.3	502352-1301	13		40.4	49.4	45.4	44	20.2	30.3	502352-1301	13
							28.3	502352-1201	12							28.3	502352-1201	12
							26.3	502352-1101	11							26.3	502352-1101	11
							24.3	502352-1001	10							24.3	502352-1001	10
							22.3	502352-0901	9							22.3	502352-0901	9
		28.4	37.4	33.4	32	14.2	20.3	502352-0801	8		28.4	37.4	33.4	32	14.2	20.3	502352-0802	8
							18.3	502352-0701	7							18.3	502352-0701	7
							16.3	502352-0601	6							16.3	502352-0602	6
							14.3	502352-0501	5							14.3	502352-0501	5
							12.3	502352-0401	4							12.3	502352-0402	4
		/	29.4	25.4	24	11.5	10.3	502352-0301	3		/	29.4	25.4	24	11.5	10.3	502352-0302	3
							8.3	502352-0201	2							8.3	502352-0202	2
							PLATING COLOR									F	E	D

THIS DRAWING CONTAINS INFORMATION THAT IS PROPRIETARY TO MOLEX ELECTRONIC TECHNOLOGIES, LLC AND SHOULD NOT BE USED WITHOUT WRITTEN PERMISSION														
DIMENSION UNITS mm		SCALE NTS		CURRENT REV DESC:										
GENERAL TOLERANCES (UNLESS SPECIFIED)		ANGULAR TOL ±		EC NO: 629663 DRWN: MSATO08 2019/12/26 CHK'D: HIJIMA 2019/12/27 APPR: TOSADA 2019/12/27										
4 PLACES ±		3 PLACES ±		INITIAL REVISION:				PRODUCT CUSTOMER DRAWING						
2 PLACES ±		1 PLACE ±		DRWN: SHSHIBATA 2007/06/19 APPR: AKANESHIGE 2007/06/19				DOCUMENT NUMBER SD-502352-002						
0 PLACES ±		THIRD ANGLE PROJECTION		DRAWING A3-SIZE		SERIES 502352		MATERIAL NUMBER SEE CHART						
DRAFT WHERE APPLICABLE MUST REMAIN WITHIN DIMENSIONS		DRAWING		SERIES		CUSTOMER GENERAL MARKET		SHEET NUMBER 2 OF 2						
<table border="1"> <tr> <td>DOCUMENT STATUS</td><td>P1</td><td>RELEASE DATE</td><td>2019/12/27</td><td>08:05:27</td> </tr> </table>										DOCUMENT STATUS	P1	RELEASE DATE	2019/12/27	08:05:27
DOCUMENT STATUS	P1	RELEASE DATE	2019/12/27	08:05:27										