

- 注記 NOTES**
- 材質
 ハウジング：耐熱性ナイロンUL94V-0
 ピン：銅合金、ニッケル下地、錫メッキ、金メッキ
 フィッティングネール：銅合金、ニッケル下地、錫メッキ
 MATERIAL
 HOUSING:POLYAMIDE UL94V-0
 PIN: COPPER ALLOY, GOLD OR TIN OVER NICKEL PLATE.
 FITTING NAIL: COPPER ALLOY, TIN OVER NICKEL PLATE.
 - 色：ナチュラル、黒、赤、青
 COLOR:NATURAL, BLACK, RED, BLUE
 - 嵌合相手
 ハウジング：502351-**0*
 錫メッキ端子：50212-8*00,50372-8*00,560085-0101
 金メッキ端子：56161-8*81
 MATES WITH
 HOUSING:502351-**0*
 SN PLATING TERMINAL:50212-8*00,50372-8*00,560085-0101
 AU PLATING TERMINAL:56161-8*81
 - エンボス梱包品の詳細はSD-502352-002参照
 DETAILED TAPING PACKAGE, SEE SD-502352-002.
 - ELV及びRoHS適合
 ELV AND RoHS COMPLIANT
 - 半田付け面のコプラナリティ：0.1mm MAX.
 CO-PLANARITY OF SOLDERING TAILS TO BE 0.1mm MAX.

- 7.一般公差**
 GENERAL TOLERANCES
 10 UNDER: ±0.2
 10 OVER 30 UNDER: ±0.25
 30 OVER: ±0.3
 ANGULAR: ±3°

INITIAL REVISION:
 DRWN SHSHIBATA 2007/12/18
 CHECK HKOMATSU 2007/12/18
 APPR AKANESHIGE 2007/12/18

| | | | | | |
|--|---|-----------------|---|----------------------------|--|
| FUNCTIONAL SYMBOLS $\nabla_A = 0$ $\nabla_B = 0$ $\nabla_C = 0$ DIVISIONAL SYMBOLS | THIS DRAWING CONTAINS INFORMATION THAT IS PROPRIETARY TO MOLEX ELECTRONIC TECHNOLOGIES, LLC AND SHOULD NOT BE USED WITHOUT WRITTEN PERMISSION | | CURRENT REV DESC: For fixing wrong view of 6ckt | | |
| | FUNCTIONAL DIMENSION UNITS | SCALE | molex | | |
| | mm | 5:1 | 2.0MM PITCH W/B CONN. WAFER ASSY R/A SMT | | |
| | GENERAL TOLERANCES (UNLESS SPECIFIED) | | PRODUCT SALES DRAWING | | |
| ANGULAR TOL ± 0.5° | | DOCUMENT NUMBER | | | |
| 4 PLACES ± | | SD-502352-001 | | DOC TYPE DOC PART REVISION | |
| 3 PLACES ± | | PSD | | 001 L4 | |
| 2 PLACES ± | | SERIES | | SHEET NUMBER | |
| 1 PLACE ± | | 502352 | | 1 OF 4 | |
| 0 PLACES ± | | MATERIAL NUMBER | | | |
| DRAFT WHERE APPLICABLE MUST REMAIN WITHIN DIMENSIONS | | CUSTOMER | | | |
| THIRD ANGLE PROJECTION | | GENERAL MARKET | | | |
| DRAWING | | A3-SIZE | | | |
| STATUS: Production | | 2024-05-14 | | | |
| DRWN: Hideo Yoneyama | | 2024-05-16 | | | |
| CHK'D: Hiromichi Komatsu | | 2024-05-16 | | | |
| APPR: Takashi Iida | | | | | |

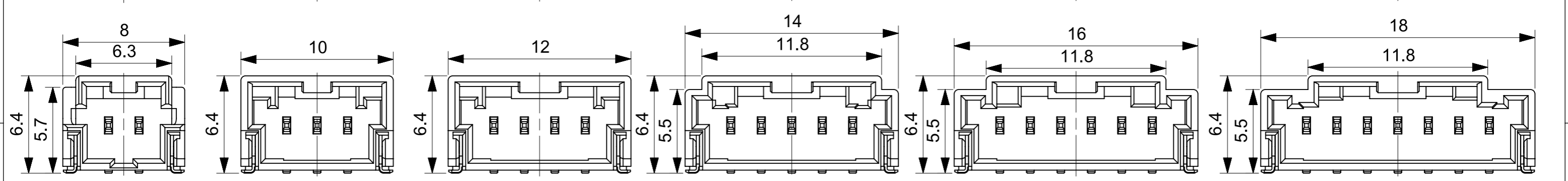
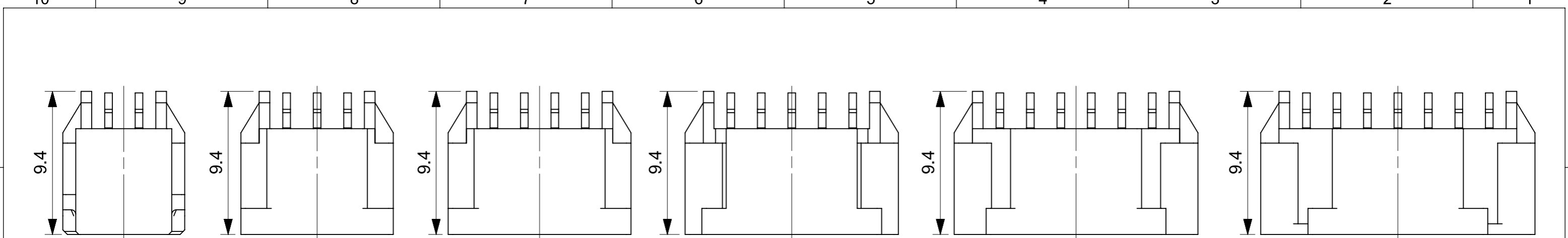

2CKTS

3CKTS

4CKTS

5CKTS

6CKTS

7CKTS

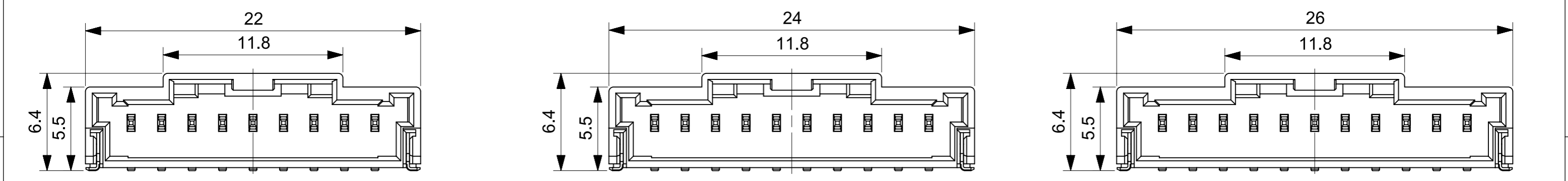
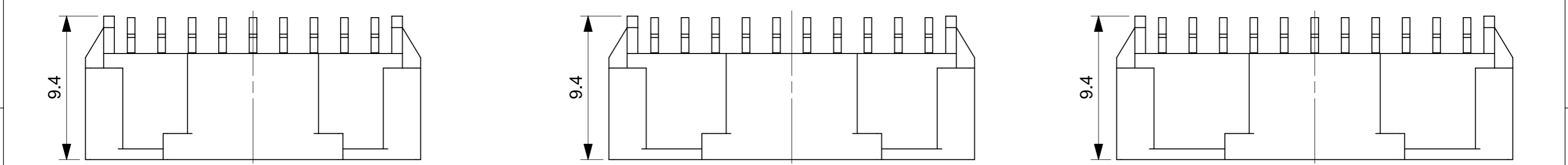

9CKTS

10CKTS

11CKTS

INITIAL REVISION:
 DRWN SHSHIBATA 2007/12/18
 CHECK HKOMATSU 2007/12/18
 APPR AKANESHIGE 2007/12/18

| | | | | | | | | |
|--|--|---------------------|--|--|---|---|----------------------------|-------------------------------|
| FUNCTIONAL SYMBOLS $\nabla_A = 0$ $\nabla_B = 0$ $\nabla_C = 0$ DIVISIONAL SYMBOLS | THIS DRAWING CONTAINS INFORMATION THAT IS PROPRIETARY TO MOLEX ELECTRONIC TECHNOLOGIES, LLC AND SHOULD NOT BE USED WITHOUT WRITTEN PERMISSION CURRENT REV DESC: For fixing wrong view of 6ckt | | | | | | | |
| | DIMENSION UNITS mm | SCALE 4:1 | | | | 2.0MM PITCH W/B CONN. WAFER ASSY R/A SMT | | |
| | GENERAL TOLERANCES (UNLESS SPECIFIED) ANGULAR TOL $\pm 0.5^\circ$ 4 PLACES \pm 3 PLACES \pm 2 PLACES \pm 1 PLACE \pm 0 PLACES \pm | | STATUS: Production DRWN: Hideo Yoneyama CHK'D: Hiromichi Komatsu APPR: Takashi Iida | 2024-05-14 2024-05-16 2024-05-16 | DOCUMENT NUMBER SD-502352-001 | DOC TYPE PSD | DOC PART 001 | REVISION L4 |
| | DRAFT WHERE APPLICABLE MUST REMAIN WITHIN DIMENSIONS | | THIRD ANGLE PROJECTION | DRAWING A3-SIZE | SERIES 502352 | MATERIAL NUMBER SEE CHART | CUSTOMER GENERAL MARKET | SHEET NUMBER 2 OF 4 |

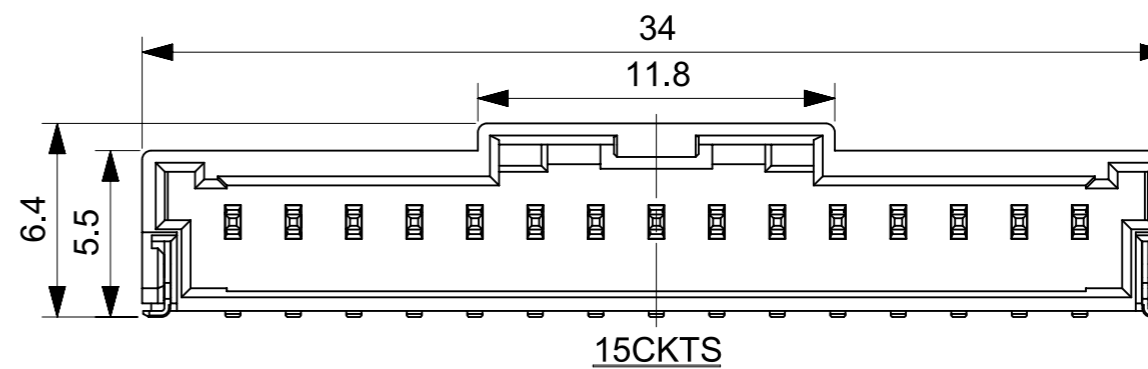
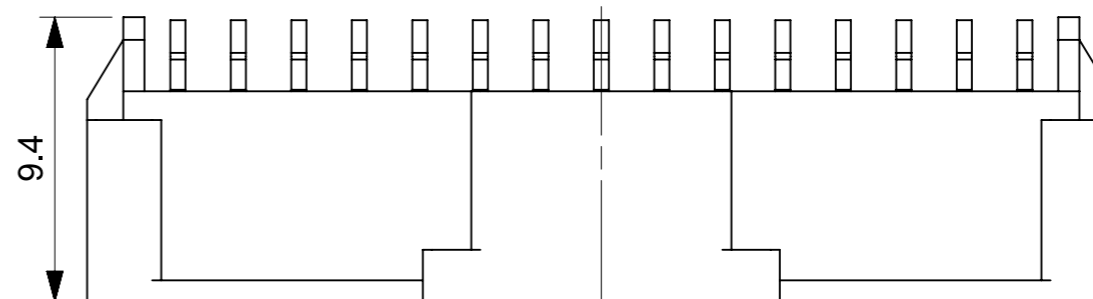
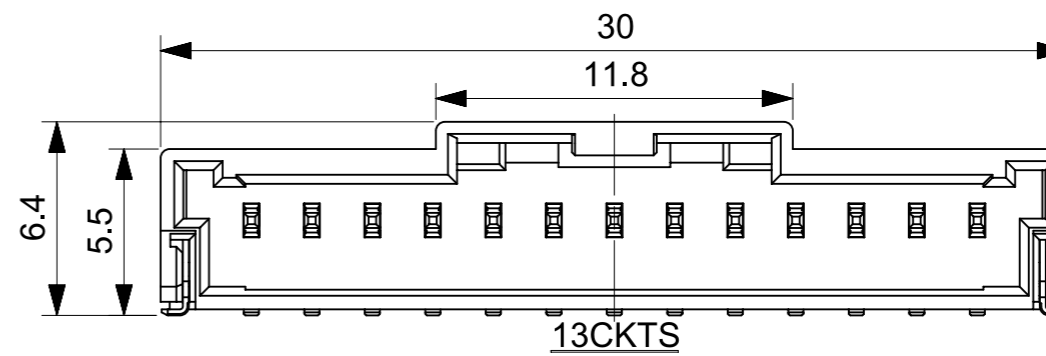
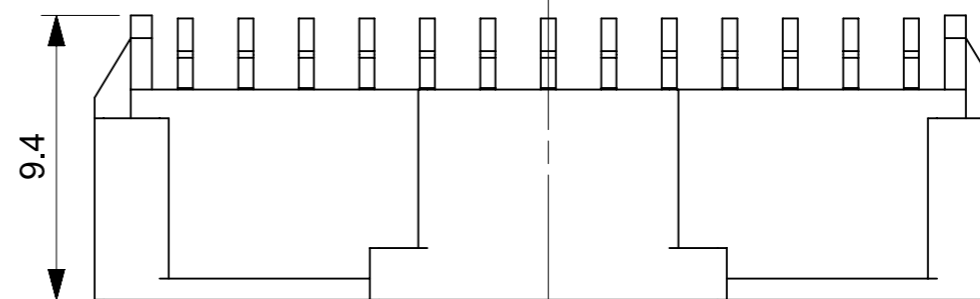
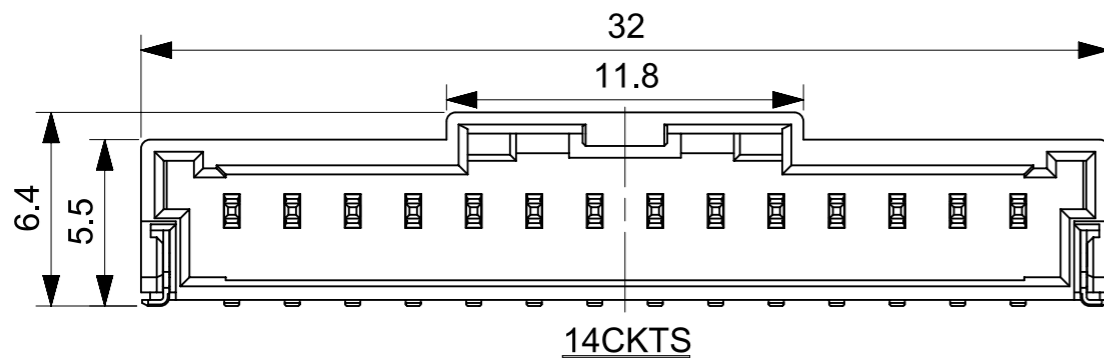
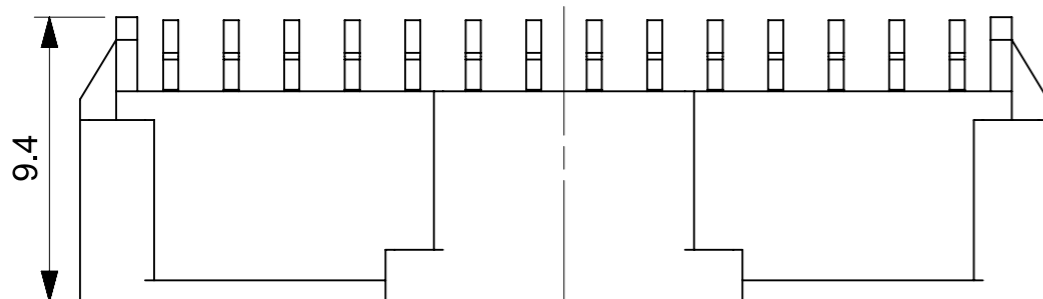
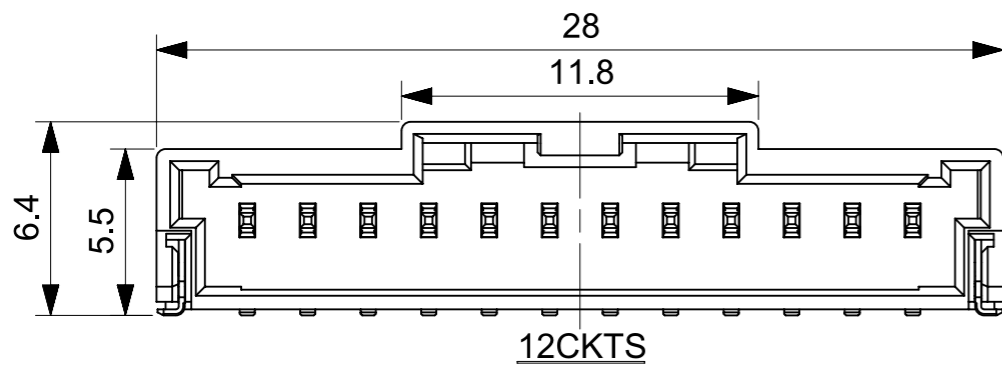
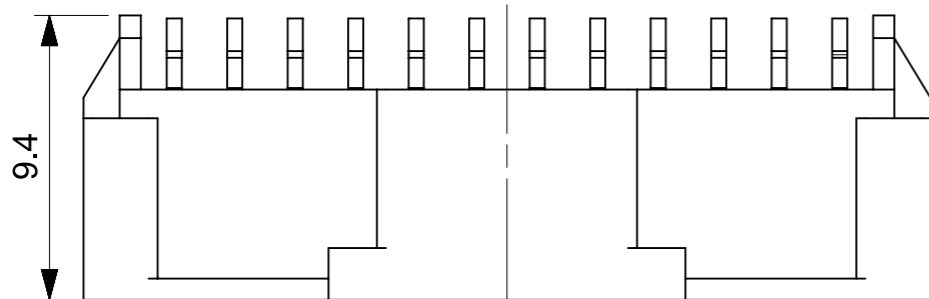

INITIAL REVISION:
 DRWN SHSHIBATA 2007/12/18
 CHECK HKOMATSU 2007/12/18
 APPR AKANESHIGE 2007/12/18

| | | |
|--|---|--|
| FUNCTIONAL SYMBOLS $\nabla/A = 0$ $\nabla/B = 0$ $\nabla/C = 0$ DIVISIONAL SYMBOLS | THIS DRAWING CONTAINS INFORMATION THAT IS PROPRIETARY TO MOLEX ELECTRONIC TECHNOLOGIES, LLC AND SHOULD NOT BE USED WITHOUT WRITTEN PERMISSION | |
| | DIMENSION UNITS | SCALE |
| | mm | 4:1 |
| | GENERAL TOLERANCES (UNLESS SPECIFIED) | |
| ANGULAR TOL ± 0.5° | | CURRENT REV DESC: For fixing wrong view of 6ckt STATUS: Production DRWN: Hideo Yoneyama 2024-05-14 CHK'D: Hiromichi Komatsu 2024-05-16 APPR: Takashi Iida 2024-05-16 |
| 4 PLACES ± | | |
| 3 PLACES ± | | |
| 2 PLACES ± | | |
| 1 PLACE ± | | |
| 0 PLACES ± | | DRAFT WHERE APPLICABLE MUST REMAIN WITHIN DIMENSIONS |
| THIRD ANGLE PROJECTION | | DRAWING A3-SIZE SERIES 502352 |
| MATERIAL NUMBER | | CUSTOMER GENERAL MARKET SHEET NUMBER 3 OF 4 |
| DOCUMENT NUMBER | | DOC TYPE DOC PART REVISION SD-502352-001 PSD 001 L4 |

molex

2.0MM PITCH W/B CONN.
 WAFER ASSY R/A SMT

PRODUCT SALES DRAWING

| | | | |
|----------------------------------|-------------|-----------------------------|------|
| Sn NATURAL | 34.0 | 502352-1500 | 15 |
| | 32.0 | 502352-1400 | 14 |
| | 30.0 | 502352-1300 | 13 |
| | 28.0 | 502352-1200 | 12 |
| | 26.0 | 502352-1100 | 11 |
| | 24.0 | 502352-1000 | 10 |
| | 22.0 | 502352-0900 | 9 |
| | 20.0 | 502352-0800 | 8 |
| | 18.0 | 502352-0700 | 7 |
| | 16.0 | 502352-0600 | 6 |
| | 14.0 | 502352-0500 | 5 |
| | 12.0 | 502352-0400 | 4 |
| 10.0 | 502352-0300 | 3 | |
| 8.0 | 502352-0200 | 2 | |
| PLATING COLOR | A | EMBOSSSED PACKAGE ORDER NO. | CKTS |
| CONNECTOR SERIES NO. 502352-**08 | | | |

| | | | |
|----------------------------------|-------------|-----------------------------|------|
| Au NATURAL | 34.0 | 502352-1510 | 15 |
| | 32.0 | 502352-1410 | 14 |
| | 30.0 | 502352-1310 | 13 |
| | 28.0 | 502352-1210 | 12 |
| | 26.0 | 502352-1110 | 11 |
| | 24.0 | 502352-1010 | 10 |
| | 22.0 | 502352-0910 | 9 |
| | 20.0 | 502352-0810 | 8 |
| | 18.0 | 502352-0710 | 7 |
| | 16.0 | 502352-0610 | 6 |
| | 14.0 | 502352-0510 | 5 |
| | 12.0 | 502352-0410 | 4 |
| 10.0 | 502352-0310 | 3 | |
| 8.0 | 502352-0210 | 2 | |
| PLATING COLOR | A | EMBOSSSED PACKAGE ORDER NO. | CKTS |
| CONNECTOR SERIES NO. 502352-**18 | | | |

| | | | |
|----------------------------------|-------------|-----------------------------|------|
| Sn BLACK | 34.0 | 502352-1501 | 15 |
| | 32.0 | 502352-1401 | 14 |
| | 30.0 | 502352-1301 | 13 |
| | 28.0 | 502352-1201 | 12 |
| | 26.0 | 502352-1101 | 11 |
| | 24.0 | 502352-1001 | 10 |
| | 22.0 | 502352-0901 | 9 |
| | 20.0 | 502352-0801 | 8 |
| | 18.0 | 502352-0701 | 7 |
| | 16.0 | 502352-0601 | 6 |
| | 14.0 | 502352-0501 | 5 |
| | 12.0 | 502352-0401 | 4 |
| 10.0 | 502352-0301 | 3 | |
| 8.0 | 502352-0201 | 2 | |
| PLATING COLOR | A | EMBOSSSED PACKAGE ORDER NO. | CKTS |
| CONNECTOR SERIES NO. 502352-**28 | | | |

| | | | |
|----------------------------------|-------------|-----------------------------|------|
| Sn RED | - | - | 15 |
| | - | - | 14 |
| | - | - | 13 |
| | - | - | 12 |
| | - | - | 11 |
| | - | - | 10 |
| | - | - | 9 |
| | 20.0 | 502352-0802 | 8 |
| | - | - | 7 |
| | 16.0 | 502352-0602 | 6 |
| | - | - | 5 |
| | 12.0 | 502352-0402 | 4 |
| 10.0 | 502352-0302 | 3 | |
| 8.0 | 502352-0202 | 2 | |
| PLATING COLOR | A | EMBOSSSED PACKAGE ORDER NO. | CKTS |
| CONNECTOR SERIES NO. 502352-**48 | | | |

| | | | |
|----------------------------------|-------------|-----------------------------|------|
| Sn BLUE | - | - | 15 |
| | - | - | 14 |
| | - | - | 13 |
| | - | - | 12 |
| | - | - | 11 |
| | - | - | 10 |
| | - | - | 9 |
| | 20.0 | 502352-0803 | 8 |
| | - | - | 7 |
| | 16.0 | 502352-0603 | 6 |
| | - | - | 5 |
| | 12.0 | 502352-0403 | 4 |
| 10.0 | 502352-0303 | 3 | |
| 8.0 | 502352-0203 | 2 | |
| PLATING COLOR | A | EMBOSSSED PACKAGE ORDER NO. | CKTS |
| CONNECTOR SERIES NO. 502352-**68 | | | |

INITIAL REVISION:
 DRWN SHSHIBATA 2007/12/18
 CHECK HKOMATSU 2007/12/18
 APPR AKANESHIGE 2007/12/18

| | | | | | | | | | | | | | | | | | |
|--|--|-------|--|---|--|---------|--|---------------|--|-----------------|--|----------------|--|--------------|--|----------|--|
| FUNCTIONAL SYMBOLS | | | | THIS DRAWING CONTAINS INFORMATION THAT IS PROPRIETARY TO MOLEX ELECTRONIC TECHNOLOGIES, LLC AND SHOULD NOT BE USED WITHOUT WRITTEN PERMISSION | | | | | | | | | | | | | |
| DIMENSION UNITS | | SCALE | | CURRENT REV DESC: For fixing wrong view of 6ckt | | | | | | | | | | | | | |
| mm | | 1:1 | | | | | | | | | | | | | | | |
| GENERAL TOLERANCES (UNLESS SPECIFIED) | | | | | | | | | | | | | | | | | |
| ANGULAR TOL ± 0.5° | | | | | | | | | | | | | | | | | |
| 4 PLACES ± | | | | | | | | | | | | | | | | | |
| 3 PLACES ± | | | | | | | | | | | | | | | | | |
| 2 PLACES ± | | | | | | | | | | | | | | | | | |
| 1 PLACE ± | | | | | | | | | | | | | | | | | |
| 0 PLACES ± | | | | | | | | | | | | | | | | | |
| DRAFT WHERE APPLICABLE MUST REMAIN WITHIN DIMENSIONS | | | | THIRD ANGLE PROJECTION | | DRAWING | | SERIES | | MATERIAL NUMBER | | CUSTOMER | | SHEET NUMBER | | | |
| | | | | | | A3-SIZE | | 502352 | | SEE CHART | | GENERAL MARKET | | 4 OF 4 | | | |
| | | | | STATUS: Production | | | | | | | | | | | | | |
| | | | | DRWN: Hideo Yoneyama | | | | 2024-05-14 | | | | | | | | | |
| | | | | CHK'D: Hiromichi Komatsu | | | | 2024-05-16 | | | | | | | | | |
| | | | | APPR: Takashi Iida | | | | 2024-05-16 | | | | | | | | | |
| | | | | DOCUMENT NUMBER | | | | SD-502352-001 | | | | DOC TYPE | | DOC PART | | REVISION | |
| | | | | | | | | | | | | PSD | | 001 | | L4 | |

molex

2.0MM PITCH W/B CONN.
 WAFER ASSY R/A SMT

PRODUCT SALES DRAWING

注記
NOTES

- 製品番号
 ナチュラル・錫めっき: 502352-**00
 ナチュラル・金めっき: 502352-**10
 黒・錫めっき: 502352-**01
 赤・錫めっき: 502352-**02
 青・錫めっき: 502352-**03
 詳細寸法については、製品単体図面を参照下さい。
 PART NO.
 NATURAL Sn Plating: 502352-**00
 NATURAL Au Plating: 502352-**10
 BLACK Sn Plating: 502352-**01
 RED Sn Plating: 502352-**02
 BLUE Sn Plating: 502352-**03
 SEE SALES DRAWING FOR CONNECTOR
- 梱包数量: 700個/リール
 NUMBER OF CONNECTORS 700PCS/REEL
- リードテープ長さ
 LEAD TAPE LENGHT
- 材料
 MATERIAL
 キャリアテープ: ポリスチレン
 CARRIER TAPE: POLYSTYRENE
 トップテープ: PET, PE, PEF
 TOP TAPE: PET, PE, PEF
 リール: ポリスチレン
 REEL: POLYSTYRENE
- 一般公差
 GENERAL TOLERANCES
 10 UNDER: ±0.2
 10 OVER 30 UNDER: ±0.25
 30 OVER: ±0.3
 ANGULAR: ±1°

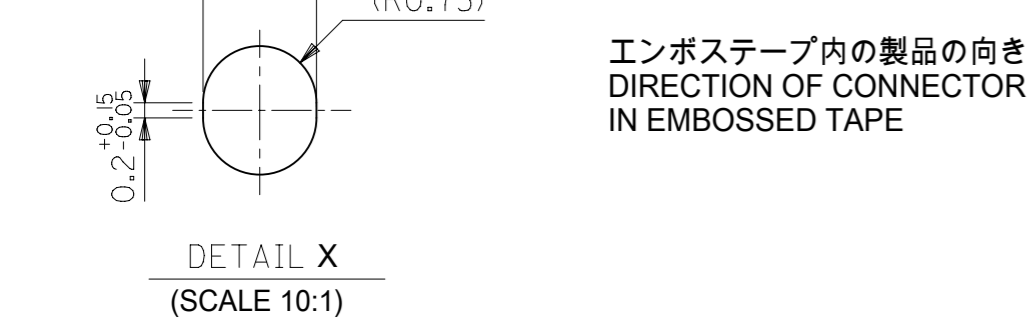
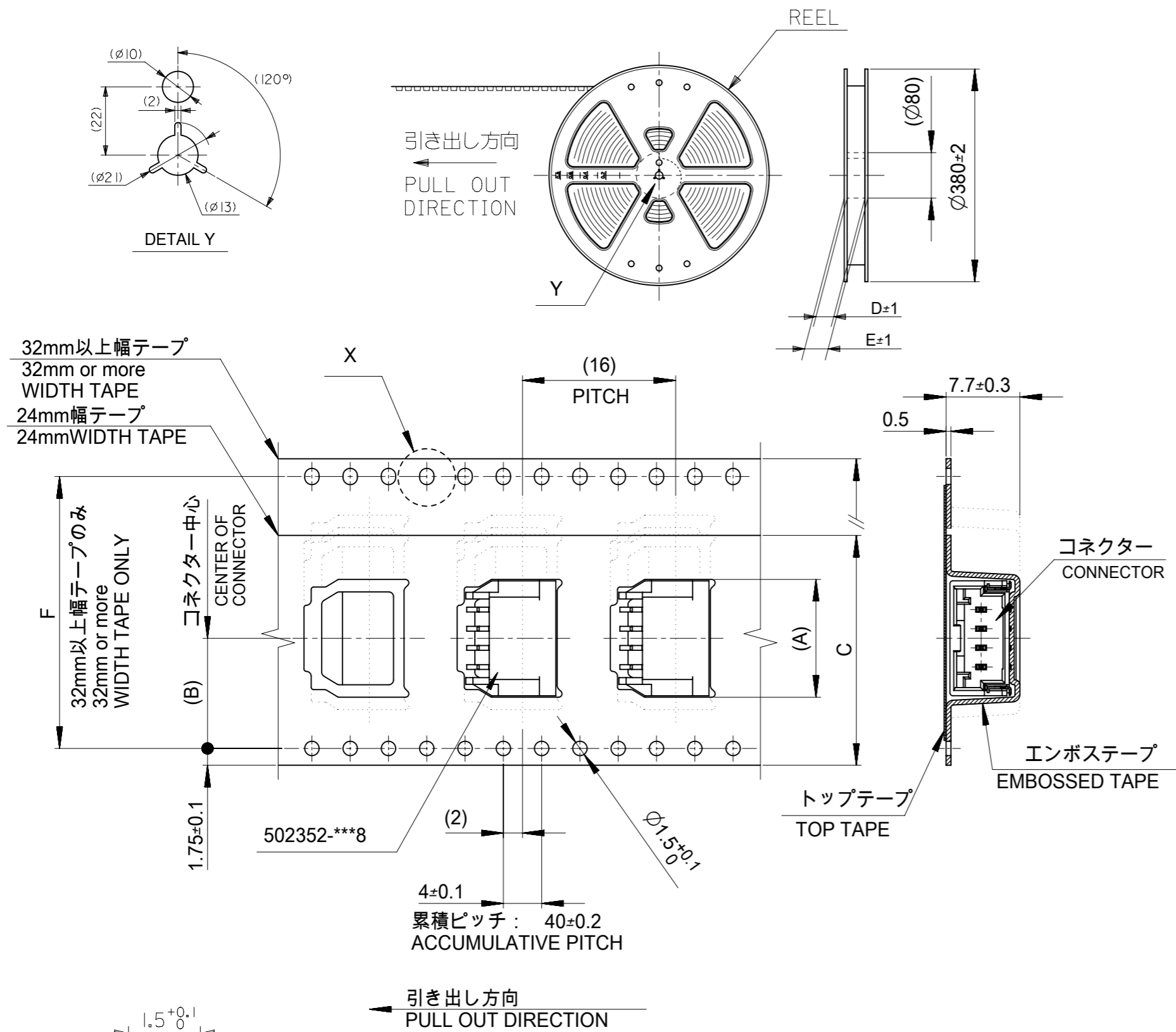
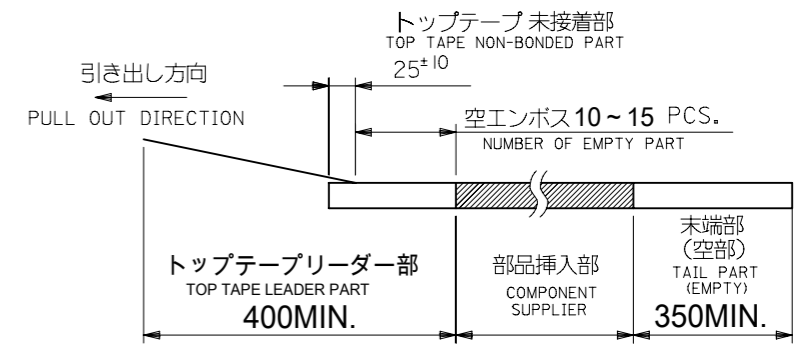

引き出し方向
PULL OUT DIRECTION

エンボステープ内の製品の向き
DIRECTION OF CONNECTOR
IN EMBOSSED TAPE

| | | | | | |
|---|-------|------------------------|------------|---|-----------------|
| THIS DRAWING CONTAINS INFORMATION THAT IS PROPRIETARY TO MOLEX ELECTRONIC TECHNOLOGIES, LLC AND SHOULD NOT BE USED WITHOUT WRITTEN PERMISSION | | CURRENT REV DESC: | | molex | |
| DIMENSION UNITS | SCALE | | | | |
| mm | NTS | | | 2.0MM PITCH W/B CONN. WAFER ASSY EMBOSSED TAPE PACKAGE | |
| GENERAL TOLERANCES (UNLESS SPECIFIED) | | EC NO: 629663 | | PRODUCT CUSTOMER DRAWING | |
| ANGULAR TOL | ± | DRWN: MSATO08 | 2019/12/26 | DOCUMENT NUMBER | |
| 4 PLACES | ± | CHK'D: HIJIMA | 2019/12/27 | SD-502352-002 | |
| 3 PLACES | ± | APPR: TOSADA | 2019/12/27 | DOC TYPE | DOC PART |
| 2 PLACES | ± | INITIAL REVISION: | | PSD | 001 |
| 1 PLACE | ± | DRWN: SHSHIBATA | 2007/06/19 | REVISION | |
| 0 PLACES | ± | APPR: AKANESHIGE | 2007/06/19 | K2 | |
| DRAFT WHERE APPLICABLE MUST REMAIN WITHIN DIMENSIONS | | THIRD ANGLE PROJECTION | DRAWING | SERIES | MATERIAL NUMBER |
| | | | A3-SIZE | 502352 | CUSTOMER |
| | | | | | GENERAL MARKET |
| | | | | | SHEET NUMBER |
| | | | | | 1 OF 2 |

INITIAL REVISION:

| | | |
|-------|------------|------------|
| DRWN | SHSHIBATA | 2007/06/06 |
| CHECK | TAITO | 2007/06/06 |
| APPR | MAYAMAMOTO | 2012/03/14 |

| | | | | | | | | | | | | | | | | | | |
|---|---------------|------|------|------|----|------|------|-------------|----|---------------|------|------|------|----|------|------|-------------|----|
| E | Sn NATURAL | 52.4 | 61.4 | 57.4 | 56 | 26.2 | 34.3 | 502352-1500 | 15 | Au NATURAL | 52.4 | 61.4 | 57.4 | 56 | 26.2 | 34.3 | 502352-1510 | 15 |
| | | | | | | | 32.3 | 502352-1400 | 14 | | | | | | | 32.3 | 502352-1410 | 14 |
| | | 40.4 | 49.4 | 45.4 | 44 | 20.2 | 30.3 | 502352-1300 | 13 | | 40.4 | 49.4 | 45.4 | 44 | 20.2 | 30.3 | 502352-1310 | 13 |
| | | | | | | | 28.3 | 502352-1200 | 12 | | | | | | | 28.3 | 502352-1210 | 12 |
| | | | | | | | 26.3 | 502352-1100 | 11 | | | | | | | 26.3 | 502352-1110 | 11 |
| | | | | | | | 24.3 | 502352-1000 | 10 | | | | | | | 24.3 | 502352-1010 | 10 |
| | | | | | | | 22.3 | 502352-0900 | 9 | | | | | | | 22.3 | 502352-0910 | 9 |
| | | 28.4 | 37.4 | 33.4 | 32 | 14.2 | 20.3 | 502352-0800 | 8 | | 28.4 | 37.4 | 33.4 | 32 | 14.2 | 20.3 | 502352-0810 | 8 |
| | | | | | | | 18.3 | 502352-0700 | 7 | | | | | | | 18.3 | 502352-0710 | 7 |
| | | | | | | | 16.3 | 502352-0600 | 6 | | | | | | | 16.3 | 502352-0610 | 6 |
| | | | | | | | 14.3 | 502352-0500 | 5 | | | | | | | 14.3 | 502352-0510 | 5 |
| | | | | | | | 12.3 | 502352-0400 | 4 | | | | | | | 12.3 | 502352-0410 | 4 |
| | | / | 29.4 | 25.4 | 24 | 11.5 | 10.3 | 502352-0300 | 3 | | / | 29.4 | 25.4 | 24 | 11.5 | 10.3 | 502352-0310 | 3 |
| | | | | | | | 8.3 | 502352-0200 | 2 | | | | | | | 8.3 | 502352-0210 | 2 |

| | | | | | | | | | | | | | | | | | | | |
|---|---------------|---|---|---|---|-----|-----|---|------------|---|---------------|---|---|---|---|-----|-----|---|------------|
| D | PLATING COLOR | F | E | D | C | (B) | (A) | エンボス梱包品 製品番号 EMBOSSED PACKAGE MATERIAL NO. | 極数 CKT. | D | PLATING COLOR | F | E | D | C | (B) | (A) | エンボス梱包品 製品番号 EMBOSSED PACKAGE MATERIAL NO. | 極数 CKT. |
|---|---------------|---|---|---|---|-----|-----|---|------------|---|---------------|---|---|---|---|-----|-----|---|------------|

| | | | | | | | | | | | | | | | | | | | | | | | | | | | |
|---|-------------|------|------|------|----|------|------|-------------|----|-----------|------|------|------|----|------|------|------------|-------------|----|------|------|------|----|------|------|-------------|----|
| C | Sn BLACK | 52.4 | 61.4 | 57.4 | 56 | 26.2 | 34.3 | 502352-1501 | 15 | Sn RED | / | / | / | / | / | 15 | Sn BLUE | / | / | / | / | / | 15 | | | | |
| | | | | | | | 32.3 | 502352-1401 | 14 | | | | | | | 14 | | | | | | | 14 | | | | |
| | | 40.4 | 49.4 | 45.4 | 44 | 20.2 | 30.3 | 502352-1301 | 13 | | 40.4 | 49.4 | 45.4 | 44 | 20.2 | 30.3 | | 502352-1301 | 13 | 40.4 | 49.4 | 45.4 | 44 | 20.2 | 30.3 | 502352-1301 | 13 |
| | | | | | | | 28.3 | 502352-1201 | 12 | | | | | | | 28.3 | | 502352-1201 | 12 | | | | | | 28.3 | 502352-1201 | 12 |
| | | | | | | | 26.3 | 502352-1101 | 11 | | | | | | | 26.3 | | 502352-1101 | 11 | | | | | | 26.3 | 502352-1101 | 11 |
| | | | | | | | 24.3 | 502352-1001 | 10 | | | | | | | 24.3 | | 502352-1001 | 10 | | | | | | 24.3 | 502352-1001 | 10 |
| | | | | | | | 22.3 | 502352-0901 | 9 | | | | | | | 22.3 | | 502352-0901 | 9 | | | | | | 22.3 | 502352-0901 | 9 |
| | | 28.4 | 37.4 | 33.4 | 32 | 14.2 | 20.3 | 502352-0801 | 8 | | 28.4 | 37.4 | 33.4 | 32 | 14.2 | 20.3 | | 502352-0802 | 8 | 28.4 | 37.4 | 33.4 | 32 | 14.2 | 20.3 | 502352-0803 | 8 |
| | | | | | | | 18.3 | 502352-0701 | 7 | | | | | | | 18.3 | | 502352-0701 | 7 | | | | | | 18.3 | 502352-0701 | 7 |
| | | | | | | | 16.3 | 502352-0601 | 6 | | | | | | | 16.3 | | 502352-0602 | 6 | | | | | | 16.3 | 502352-0603 | 6 |
| | | | | | | | 14.3 | 502352-0501 | 5 | | | | | | | 14.3 | | 502352-0501 | 5 | | | | | | 14.3 | 502352-0501 | 5 |
| | | | | | | | 12.3 | 502352-0401 | 4 | | | | | | | 12.3 | | 502352-0402 | 4 | | | | | | 12.3 | 502352-0403 | 4 |
| | | / | 29.4 | 25.4 | 24 | 11.5 | 10.3 | 502352-0301 | 3 | | / | 29.4 | 25.4 | 24 | 11.5 | 10.3 | | 502352-0302 | 3 | / | 29.4 | 25.4 | 24 | 11.5 | 10.3 | 502352-0303 | 3 |
| | | | | | | | 8.3 | 502352-0201 | 2 | | | | | | | 8.3 | | 502352-0202 | 2 | | | | | | 8.3 | 502352-0203 | 2 |

| | | | | | | | | | | | | | | | | | | | |
|---|---------------|---|---|---|---|-----|-----|---|------------|---|---------------|---|---|---|---|-----|-----|---|------------|
| B | PLATING COLOR | F | E | D | C | (B) | (A) | エンボス梱包品 製品番号 EMBOSSED PACKAGE MATERIAL NO. | 極数 CKT. | B | PLATING COLOR | F | E | D | C | (B) | (A) | エンボス梱包品 製品番号 EMBOSSED PACKAGE MATERIAL NO. | 極数 CKT. |
|---|---------------|---|---|---|---|-----|-----|---|------------|---|---------------|---|---|---|---|-----|-----|---|------------|

| | | | | | | | | | | | |
|---|--|-----------------------------------|--|--|--|----------------------------|--|----------------------------|--|---|--|
| THIS DRAWING CONTAINS INFORMATION THAT IS PROPRIETARY TO MOLEX ELECTRONIC TECHNOLOGIES, LLC AND SHOULD NOT BE USED WITHOUT WRITTEN PERMISSION | | | | | | | | | | | |
| DIMENSION UNITS: mm | | SCALE: NTS | | CURRENT REV DESC: | | | | | |  | |
| GENERAL TOLERANCES (UNLESS SPECIFIED) | | ANGULAR TOL ± ° | | EC NO: 629663 DRWN: MSATO08 2019/12/26 CHK'D: HIJIMA 2019/12/27 APPR: TOSADA 2019/12/27 | | | | | | | |
| 4 PLACES ± | | 3 PLACES ± | | 2 PLACES ± | | 1 PLACE ± | | 0 PLACES ± | | PRODUCT CUSTOMER DRAWING | |
| DRAFT WHERE APPLICABLE MUST REMAIN WITHIN DIMENSIONS | | THIRD ANGLE PROJECTION | | DRAWING: A3-SIZE | | SERIES: 502352 | | MATERIAL NUMBER: SEE CHART | | CUSTOMER: GENERAL MARKET | |
| DOCUMENT STATUS: P1 | | RELEASE DATE: 2019/12/27 08:05:27 | | INITIAL REVISION: | | DRWN: SHSHIBATA 2007/06/06 | | CHECK: TAITO 2007/06/06 | | APPR: MAYAMAMOTO 2012/03/14 | |
| DOCUMENT NUMBER: SD-502352-002 | | DOC TYPE: PSD | | DOC PART: 001 | | REVISION: K2 | | SHEET NUMBER: 2 OF 2 | | | |