

- 注記
NOTES
- 材質
ハウジング：耐熱性ナイロンUL94V-0
ピン：銅合金、ニッケル下地、錫メッキ、金メッキ
フィッティングネール：銅合金、ニッケル下地、錫メッキ
MATERIAL
HOUSING:POLYAMIDE UL94V-0
PIN: COPPER ALLOY, GOLD OR TIN OVER NICKEL PLATE.
FITTING NAIL: COPPER ALLOY, TIN OVER NICKEL PLATE.
 - 色：ナチュラル、黒、赤、青
COLOR:NATURAL, BLACK, RED, BLUE
 - 嵌合相手
ハウジング：502351-**0*
錫メッキ端子：50212-8*00,50372-8*00,560085-0101
金メッキ端子：56161-8*81
MATES WITH
HOUSING:502351-**0*
SN PLATING TERMINAL:50212-8*00,50372-8*00,560085-0101
AU PLATING TERMINAL:56161-8*81
 - エンボス梱包品の詳細はSD-502352-002参照
DETAILED TAPING PACKAGE, SEE SD-502352-002.
 - ELV及びRoHS適合
ELV AND RoHS COMPLIANT
 - 半田付け面のコプラナリティ：0.1mm MAX.
CO-PLANARITY OF SOLDERING TAILS TO BE 0.1mm MAX.

- 7.一般公差
GENERAL TOLERANCES
10 UNDER: ±0.2
10 OVER 30 UNDER: ±0.25
30 OVER: ±0.3
ANGULAR: ±3°

INITIAL REVISION:
DRWN SHSHIBATA 2007/12/18
CHECK HKOMATSU 2007/12/18
APPR AKANESHIGE 2007/12/18

FUNCTIONAL SYMBOLS ▽A=0 ▽B=0 ▽C=0 ▽D=0 DIVISIONAL SYMBOLS	THIS DRAWING CONTAINS INFORMATION THAT IS PROPRIETARY TO MOLEX ELECTRONIC TECHNOLOGIES, LLC AND SHOULD NOT BE USED WITHOUT WRITTEN PERMISSION		CURRENT REV DESC: For fixing wrong view of 6ckt							
	FUNCTIONAL DIMENSION UNITS	SCALE	<p>2.0MM PITCH W/B CONN. WAFER ASSY R/A SMT</p> <p>PRODUCT SALES DRAWING</p>							
	mm	5:1								
	GENERAL TOLERANCES (UNLESS SPECIFIED)									
ANGULAR TOL ± 0.5°										
4 PLACES ±		STATUS: Production								
3 PLACES ±		DRWN: Hideo Yoneyama 2024-05-14								
2 PLACES ±		CHK'D: Hiromichi Komatsu 2024-05-16								
1 PLACE ±		APPR: Takashi Iida 2024-05-16								
0 PLACES ±		DOCUMENT NUMBER: SD-502352-001								
DRAFT WHERE APPLICABLE MUST REMAIN WITHIN DIMENSIONS		THIRD ANGLE PROJECTION	DRAWING: A3-SIZE	SERIES: 502352	MATERIAL NUMBER: SEE CHART	CUSTOMER: GENERAL MARKET	DOC TYPE: PSD	DOC PART: 001	REVISION: L4	SHEET NUMBER: 1 OF 4

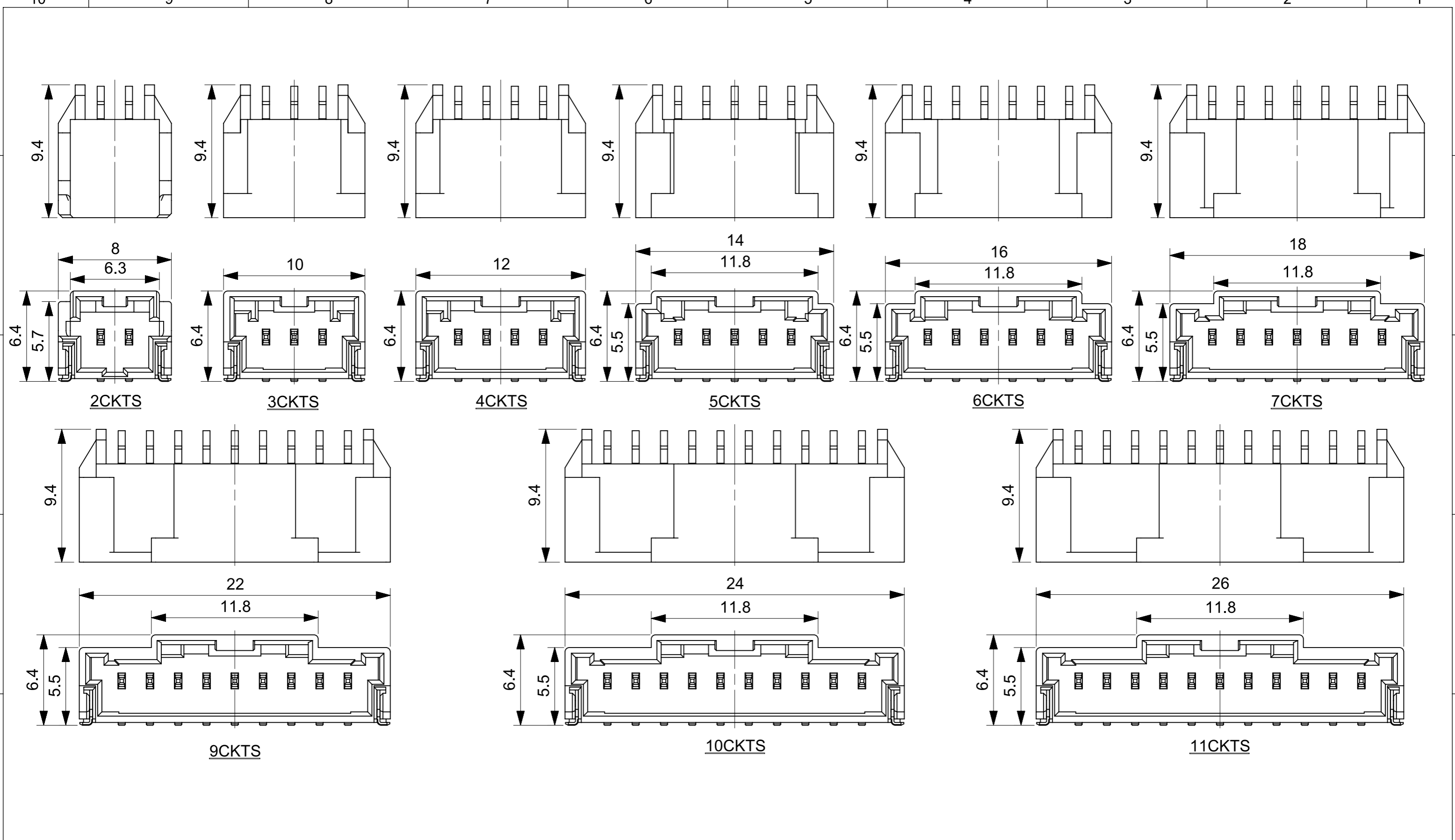

INITIAL REVISION:
 DRWN SHSHIBATA 2007/12/18
 CHECK HKOMATSU 2007/12/18
 APPR AKANESHIGE 2007/12/18

FUNCTIONAL SYMBOLS $\nabla A = 0$ $\nabla B = 0$ $\nabla C = 0$ DIVISIONAL SYMBOLS	THIS DRAWING CONTAINS INFORMATION THAT IS PROPRIETARY TO MOLEX ELECTRONIC TECHNOLOGIES, LLC AND SHOULD NOT BE USED WITHOUT WRITTEN PERMISSION CURRENT REV DESC: For fixing wrong view of 6ckt		molex 2.0MM PITCH W/B CONN. WAFER ASSY R/A SMT				
	DIMENSION UNITS: mm SCALE: 4:1	GENERAL TOLERANCES (UNLESS SPECIFIED) ANGULAR TOL $\pm 0.5^\circ$ 4 PLACES \pm 3 PLACES \pm 2 PLACES \pm 1 PLACE \pm 0 PLACES \pm				PRODUCT SALES DRAWING	
	STATUS: Production DRWN: Hideo Yoneyama CHK'D: Hiromichi Komatsu APPR: Takashi Iida		2024-05-14 2024-05-16 2024-05-16	DOCUMENT NUMBER SD-502352-001	DOC TYPE PSD	DOC PART 001	REVISION L4
	DRAFT WHERE APPLICABLE MUST REMAIN WITHIN DIMENSIONS	THIRD ANGLE PROJECTION 	DRAWING A3-SIZE	SERIES 502352	MATERIAL NUMBER SEE CHART	CUSTOMER GENERAL MARKET	SHEET NUMBER 2 OF 4

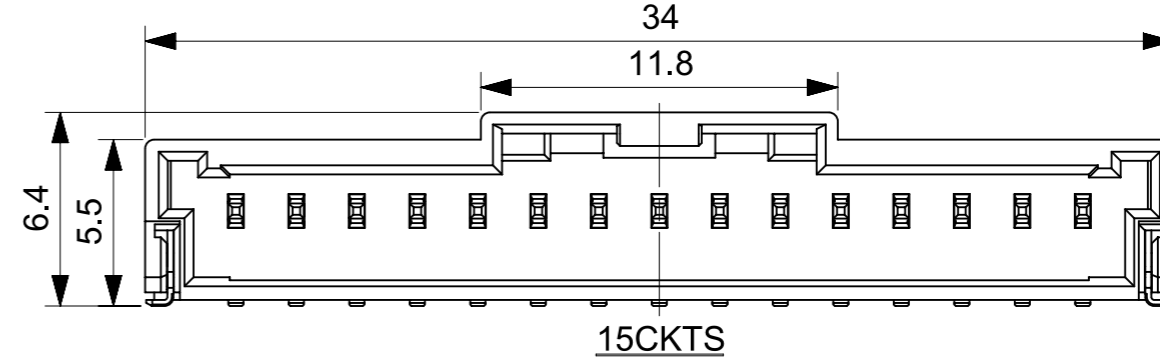
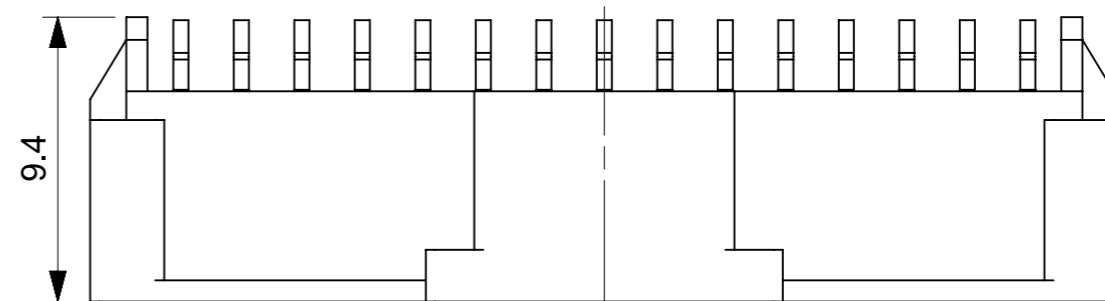
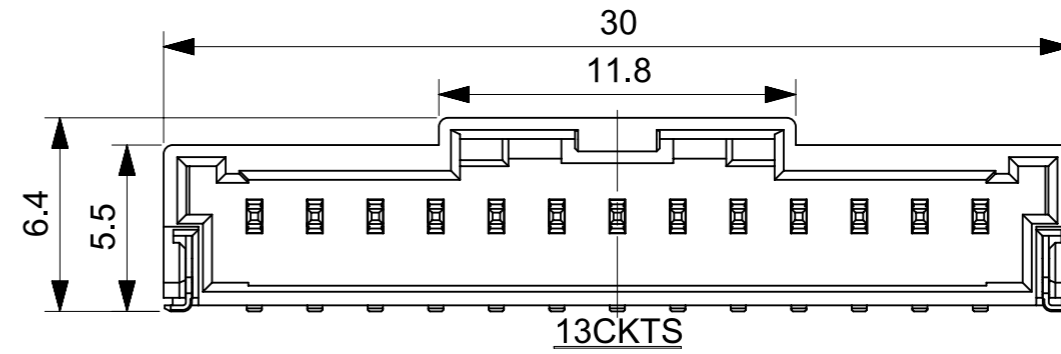
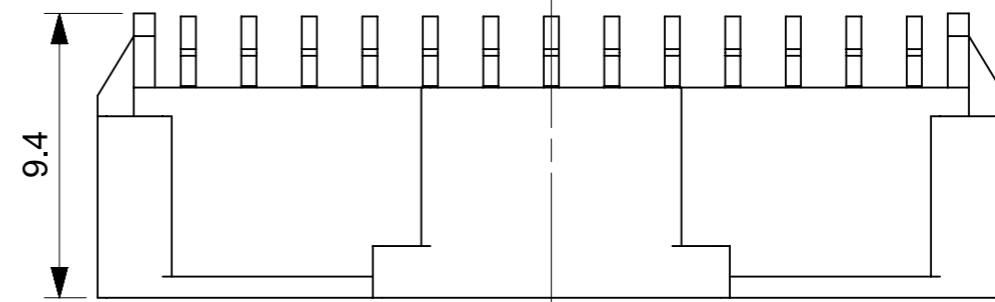
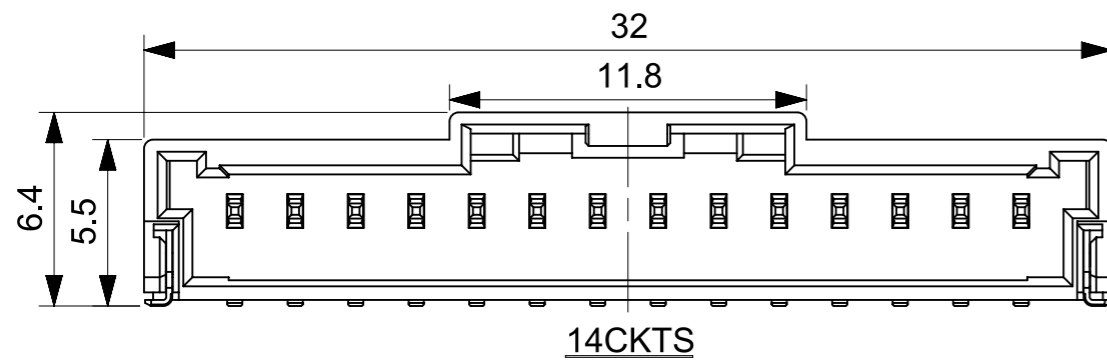
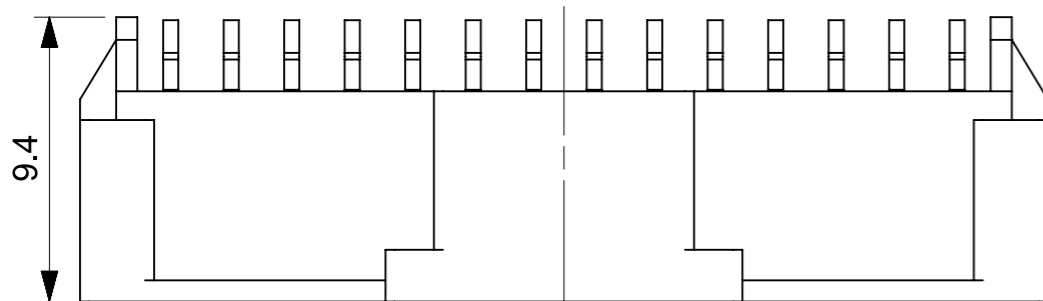
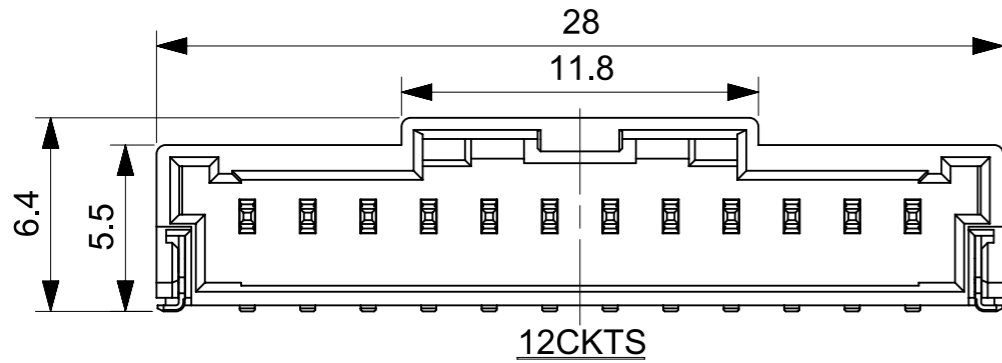
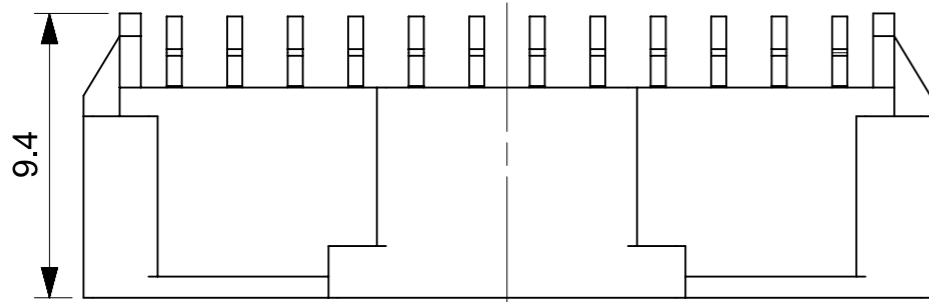

INITIAL REVISION:
 DRWN SHSHIBATA 2007/12/18
 CHECK HKOMATSU 2007/12/18
 APPR AKANESHIGE 2007/12/18

FUNCTIONAL SYMBOLS $\nabla/A = 0$ $\nabla/B = 0$ $\nabla/C = 0$ DIVISIONAL SYMBOLS	THIS DRAWING CONTAINS INFORMATION THAT IS PROPRIETARY TO MOLEX ELECTRONIC TECHNOLOGIES, LLC AND SHOULD NOT BE USED WITHOUT WRITTEN PERMISSION CURRENT REV DESC: For fixing wrong view of 6ckt	
	DIMENSION UNITS mm	SCALE 4:1
	GENERAL TOLERANCES (UNLESS SPECIFIED) ANGULAR TOL $\pm 0.5^\circ$ 4 PLACES \pm 3 PLACES \pm 2 PLACES \pm 1 PLACE \pm 0 PLACES \pm	
	DRAFT WHERE APPLICABLE MUST REMAIN WITHIN DIMENSIONS THIRD ANGLE PROJECTION 	
STATUS: Production DRWN: Hideo Yoneyama 2024-05-14 CHK'D: Hiromichi Komatsu 2024-05-16 APPR: Takashi Iida 2024-05-16		DOCUMENT NUMBER SD-502352-001
DRAWING A3-SIZE		SERIES 502352
MATERIAL NUMBER SEE CHART		CUSTOMER GENERAL MARKET
SHEET NUMBER 3 OF 4		DOC TYPE DOC PART REVISION PSD 001 L4

molex

2.0MM PITCH W/B CONN.
 WAFER ASSY R/A SMT

PRODUCT SALES DRAWING

Sn NATURAL	34.0	502352-1500	15
	32.0	502352-1400	14
	30.0	502352-1300	13
	28.0	502352-1200	12
	26.0	502352-1100	11
	24.0	502352-1000	10
	22.0	502352-0900	9
	20.0	502352-0800	8
	18.0	502352-0700	7
	16.0	502352-0600	6
	14.0	502352-0500	5
	12.0	502352-0400	4
10.0	502352-0300	3	
8.0	502352-0200	2	
PLATING COLOR	A	EMBOSSSED PACKAGE ORDER NO.	CKTS
CONNECTOR SERIES NO. 502352-**08			

Au NATURAL	34.0	502352-1510	15
	32.0	502352-1410	14
	30.0	502352-1310	13
	28.0	502352-1210	12
	26.0	502352-1110	11
	24.0	502352-1010	10
	22.0	502352-0910	9
	20.0	502352-0810	8
	18.0	502352-0710	7
	16.0	502352-0610	6
	14.0	502352-0510	5
	12.0	502352-0410	4
10.0	502352-0310	3	
8.0	502352-0210	2	
PLATING COLOR	A	EMBOSSSED PACKAGE ORDER NO.	CKTS
CONNECTOR SERIES NO. 502352-**18			

Sn BLACK	34.0	502352-1501	15
	32.0	502352-1401	14
	30.0	502352-1301	13
	28.0	502352-1201	12
	26.0	502352-1101	11
	24.0	502352-1001	10
	22.0	502352-0901	9
	20.0	502352-0801	8
	18.0	502352-0701	7
	16.0	502352-0601	6
	14.0	502352-0501	5
	12.0	502352-0401	4
10.0	502352-0301	3	
8.0	502352-0201	2	
PLATING COLOR	A	EMBOSSSED PACKAGE ORDER NO.	CKTS
CONNECTOR SERIES NO. 502352-**28			

Sn RED	-	-	15
	-	-	14
	-	-	13
	-	-	12
	-	-	11
	-	-	10
	-	-	9
	20.0	502352-0802	8
	-	-	7
	16.0	502352-0602	6
	-	-	5
	12.0	502352-0402	4
10.0	502352-0302	3	
8.0	502352-0202	2	
PLATING COLOR	A	EMBOSSSED PACKAGE ORDER NO.	CKTS
CONNECTOR SERIES NO. 502352-**48			

Sn BLUE	-	-	15
	-	-	14
	-	-	13
	-	-	12
	-	-	11
	-	-	10
	-	-	9
	20.0	502352-0803	8
	-	-	7
	16.0	502352-0603	6
	-	-	5
	12.0	502352-0403	4
10.0	502352-0303	3	
8.0	502352-0203	2	
PLATING COLOR	A	EMBOSSSED PACKAGE ORDER NO.	CKTS
CONNECTOR SERIES NO. 502352-**68			

INITIAL REVISION:
 DRWN SHSHIBATA 2007/12/18
 CHECK HKOMATSU 2007/12/18
 APPR AKANESHIGE 2007/12/18

FUNCTIONAL SYMBOLS				THIS DRAWING CONTAINS INFORMATION THAT IS PROPRIETARY TO MOLEX ELECTRONIC TECHNOLOGIES, LLC AND SHOULD NOT BE USED WITHOUT WRITTEN PERMISSION							
DIMENSION UNITS		SCALE		CURRENT REV DESC: For fixing wrong view of 6ckt							
mm		1:1									
GENERAL TOLERANCES (UNLESS SPECIFIED)											
ANGULAR TOL ± 0.5°											
4 PLACES ±											
3 PLACES ±											
2 PLACES ±											
1 PLACE ±											
0 PLACES ±											
DRAFT WHERE APPLICABLE MUST REMAIN WITHIN DIMENSIONS											
THIRD ANGLE PROJECTION		DRAWING		SERIES		MATERIAL NUMBER		CUSTOMER		SHEET NUMBER	
		A3-SIZE		502352		SEE CHART		GENERAL MARKET		4 OF 4	
STATUS: Production											
DRWN: Hideo Yoneyama				2024-05-14							
CHK'D: Hiromichi Komatsu				2024-05-16							
APPR: Takashi Iida				2024-05-16							
DOCUMENT NUMBER				DOC TYPE		DOC PART		REVISION			
SD-502352-001				PSD		001		L4			



2.0MM PITCH W/B CONN.
 WAFER ASSY R/A SMT

PRODUCT SALES DRAWING

注記
NOTES

- 製品番号
 ナチュラル・錫めっき: 502352-**00
 ナチュラル・金めっき: 502352-**10
 黒・錫めっき: 502352-**01
 赤・錫めっき: 502352-**02
 青・錫めっき: 502352-**03
 詳細寸法については、製品単体図面を参照下さい。
 PART NO.
 NATURAL Sn Plating: 502352-**00
 NATURAL Au Plating: 502352-**10
 BLACK Sn Plating: 502352-**01
 RED Sn Plating: 502352-**02
 BLUE Sn Plating: 502352-**03
 SEE SALES DRAWING FOR CONNECTOR
- 梱包数量: 700個/リール
 NUMBER OF CONNECTORS 700PCS/REEL
- リードテープ長さ
 LEAD TAPE LENGHT
- 材料
 MATERIAL
 キャリアテープ: ポリスチレン
 CARRIER TAPE: POLYSTYRENE
 トップテープ: PET, PE, PEF
 TOP TAPE: PET, PE, PEF
 リール: ポリスチレン
 REEL: POLYSTYRENE
- 一般公差
 GENERAL TOLERANCES
 10 UNDER: ±0.2
 10 OVER 30 UNDER: ±0.25
 30 OVER: ±0.3
 ANGULAR: ±1°

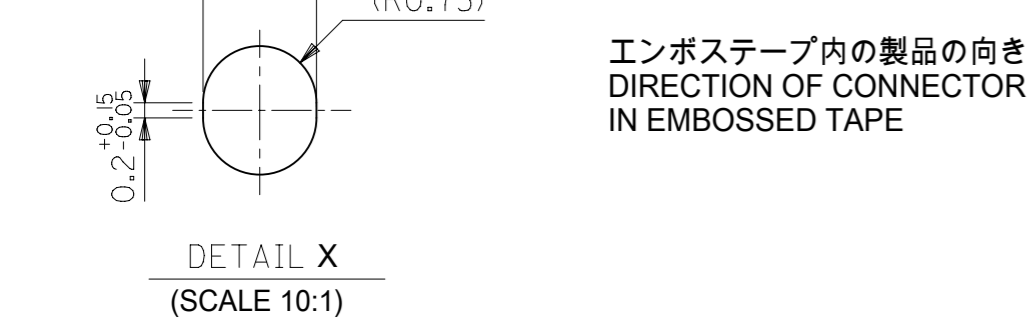
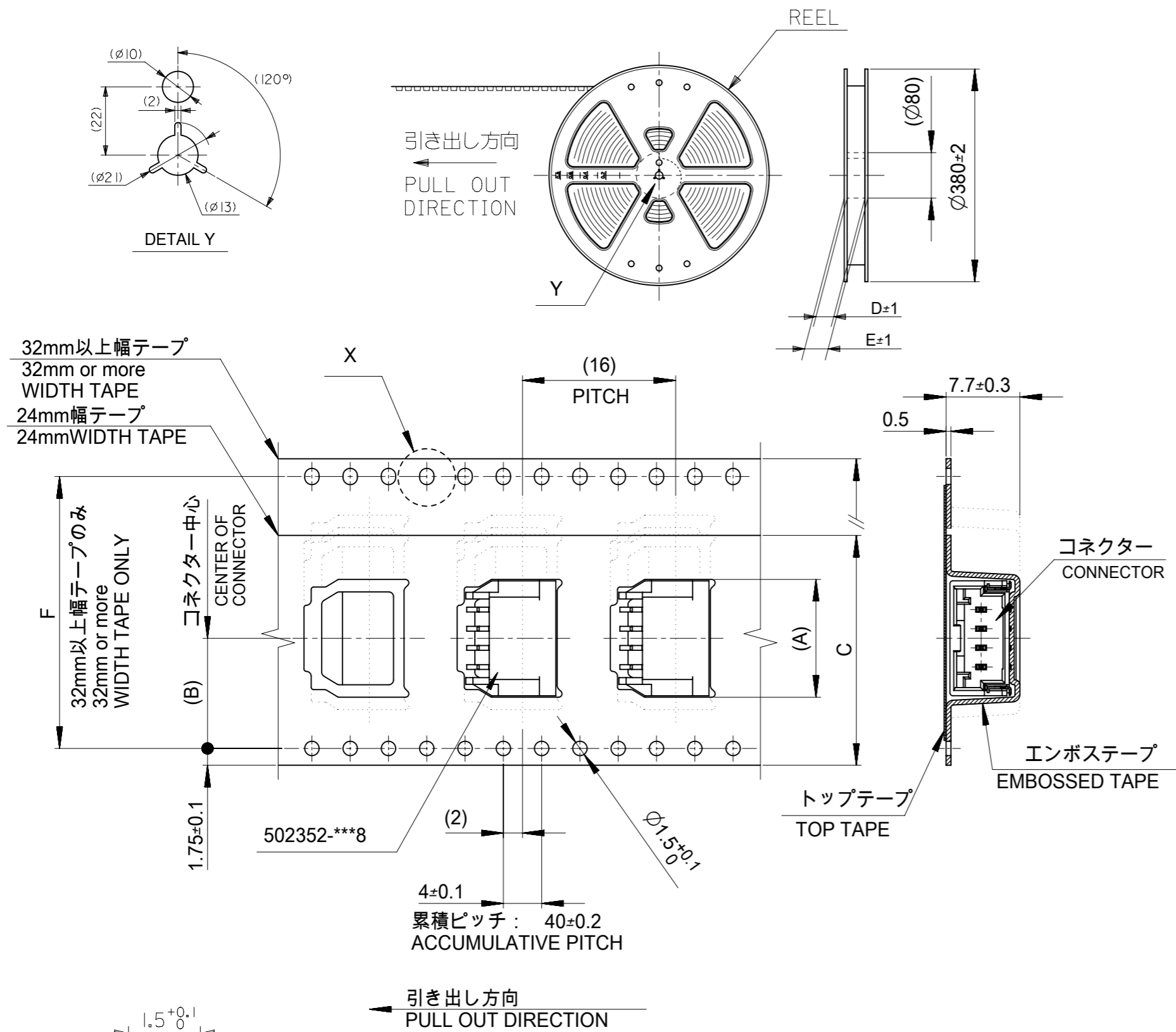
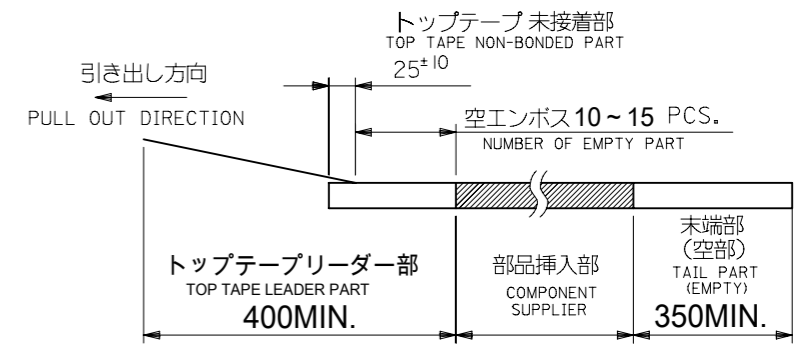

THIS DRAWING CONTAINS INFORMATION THAT IS PROPRIETARY TO MOLEX ELECTRONIC TECHNOLOGIES, LLC AND SHOULD NOT BE USED WITHOUT WRITTEN PERMISSION		CURRENT REV DESC:		molex	
DIMENSION UNITS	SCALE				
mm	NTS			2.0MM PITCH W/B CONN. WAFER ASSY EMBOSSED TAPE PACKAGE	
GENERAL TOLERANCES (UNLESS SPECIFIED)		EC NO: 629663		PRODUCT CUSTOMER DRAWING	
ANGULAR TOL	± °	DRWN: MSATO08	2019/12/26	DOCUMENT NUMBER	
4 PLACES	±	CHK'D: HIJIMA	2019/12/27	SD-502352-002	
3 PLACES	±	APPR: TOSADA	2019/12/27	DOC TYPE	DOC PART
2 PLACES	±	INITIAL REVISION:		PSD	001
1 PLACE	±	DRWN: SHSHIBATA	2007/06/19	REVISION	
0 PLACES	±	APPR: AKANESHIGE	2007/06/19	K2	
DRAFT WHERE APPLICABLE MUST REMAIN WITHIN DIMENSIONS		THIRD ANGLE PROJECTION	DRAWING	SERIES	MATERIAL NUMBER
			A3-SIZE	502352	CUSTOMER
					GENERAL MARKET
					SHEET NUMBER
					1 OF 2

INITIAL REVISION:		
DRWN	SHSHIBATA	2007/06/06
CHECK	TAITO	2007/06/06
APPR	MAYAMAMOTO	2012/03/14

E	Sn NATURAL	52.4	61.4	57.4	56	26.2	34.3	502352-1500	15	Au NATURAL	52.4	61.4	57.4	56	26.2	34.3	502352-1510	15
							32.3	502352-1400	14							32.3	502352-1410	14
		40.4	49.4	45.4	44	20.2	30.3	502352-1300	13		40.4	49.4	45.4	44	20.2	30.3	502352-1310	13
							28.3	502352-1200	12							28.3	502352-1210	12
							26.3	502352-1100	11							26.3	502352-1110	11
							24.3	502352-1000	10							24.3	502352-1010	10
							22.3	502352-0900	9							22.3	502352-0910	9
		28.4	37.4	33.4	32	14.2	20.3	502352-0800	8		28.4	37.4	33.4	32	14.2	20.3	502352-0810	8
							18.3	502352-0700	7							18.3	502352-0710	7
							16.3	502352-0600	6							16.3	502352-0610	6
							14.3	502352-0500	5							14.3	502352-0510	5
							12.3	502352-0400	4							12.3	502352-0410	4
		/	29.4	25.4	24	11.5	10.3	502352-0300	3		/	29.4	25.4	24	11.5	10.3	502352-0310	3
							8.3	502352-0200	2							8.3	502352-0210	2
							PLATING COLOR									F	E	D

C	Sn BLACK	52.4	61.4	57.4	56	26.2	34.3	502352-1501	15	Sn RED	/	/	/	/	/	/	/	15
							32.3	502352-1401	14									14
		40.4	49.4	45.4	44	20.2	30.3	502352-1301	13		40.4	49.4	45.4	44	20.2	30.3	502352-1301	13
							28.3	502352-1201	12							28.3	502352-1201	12
							26.3	502352-1101	11							26.3	502352-1101	11
							24.3	502352-1001	10							24.3	502352-1001	10
							22.3	502352-0901	9							22.3	502352-0901	9
		28.4	37.4	33.4	32	14.2	20.3	502352-0801	8		28.4	37.4	33.4	32	14.2	20.3	502352-0802	8
							18.3	502352-0701	7							18.3	502352-0701	7
							16.3	502352-0601	6							16.3	502352-0602	6
							14.3	502352-0501	5							14.3	502352-0501	5
							12.3	502352-0401	4							12.3	502352-0402	4
		/	29.4	25.4	24	11.5	10.3	502352-0301	3		/	29.4	25.4	24	11.5	10.3	502352-0302	3
							8.3	502352-0201	2							8.3	502352-0202	2
							PLATING COLOR									F	E	D

THIS DRAWING CONTAINS INFORMATION THAT IS PROPRIETARY TO MOLEX ELECTRONIC TECHNOLOGIES, LLC AND SHOULD NOT BE USED WITHOUT WRITTEN PERMISSION														
DIMENSION UNITS mm		SCALE NTS		CURRENT REV DESC:										
GENERAL TOLERANCES (UNLESS SPECIFIED)		ANGULAR TOL ±		EC NO: 629663 DRWN: MSATO08 2019/12/26 CHK'D: HIJIMA 2019/12/27 APPR: TOSADA 2019/12/27										
4 PLACES ±		3 PLACES ±		INITIAL REVISION:				PRODUCT CUSTOMER DRAWING						
2 PLACES ±		1 PLACE ±		DRWN: SHSHIBATA 2007/06/19 APPR: AKANESHIGE 2007/06/19				DOCUMENT NUMBER SD-502352-002						
0 PLACES ±		THIRD ANGLE PROJECTION		DRAWING A3-SIZE		SERIES 502352		MATERIAL NUMBER SEE CHART						
DRAFT WHERE APPLICABLE MUST REMAIN WITHIN DIMENSIONS		DRAWING		SERIES		CUSTOMER GENERAL MARKET		SHEET NUMBER 2 OF 2						
<table border="1"> <tr> <td>DOCUMENT STATUS</td> <td>P1</td> <td>RELEASE DATE</td> <td>2019/12/27</td> <td>08:05:27</td> </tr> </table>										DOCUMENT STATUS	P1	RELEASE DATE	2019/12/27	08:05:27
DOCUMENT STATUS	P1	RELEASE DATE	2019/12/27	08:05:27										