

171692-0110

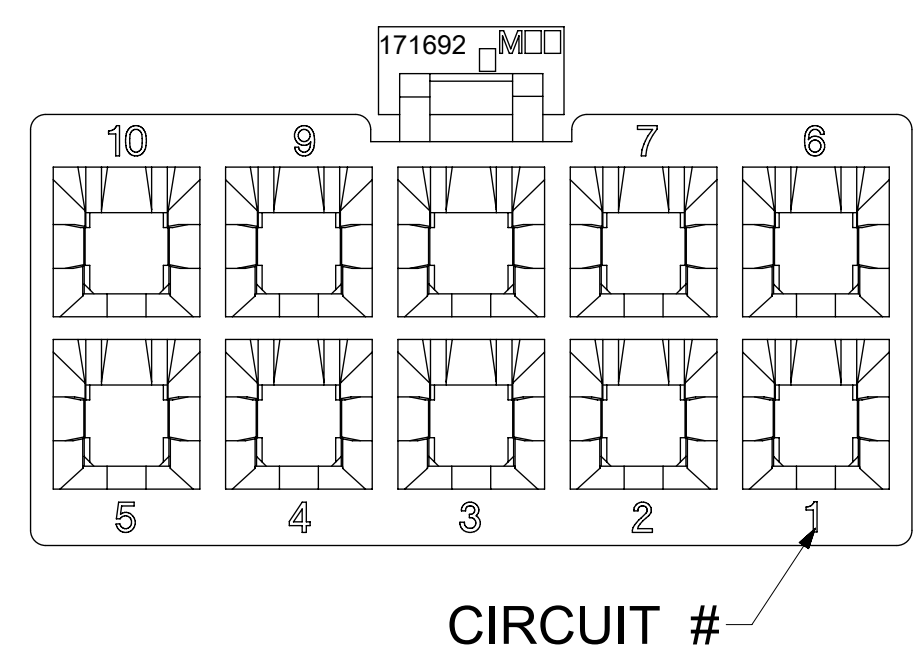
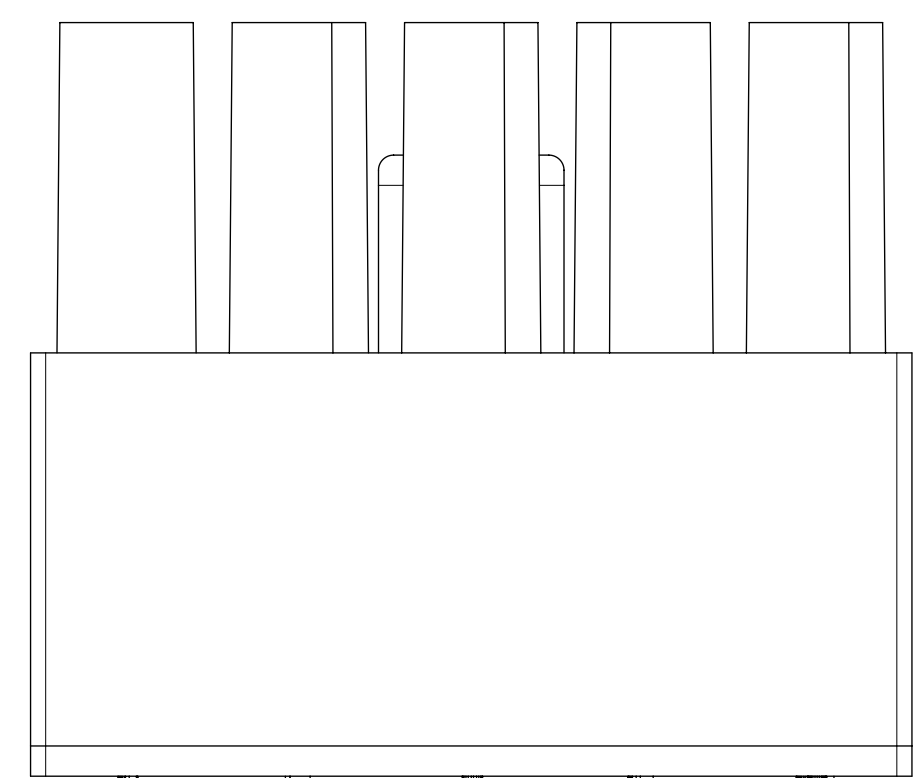
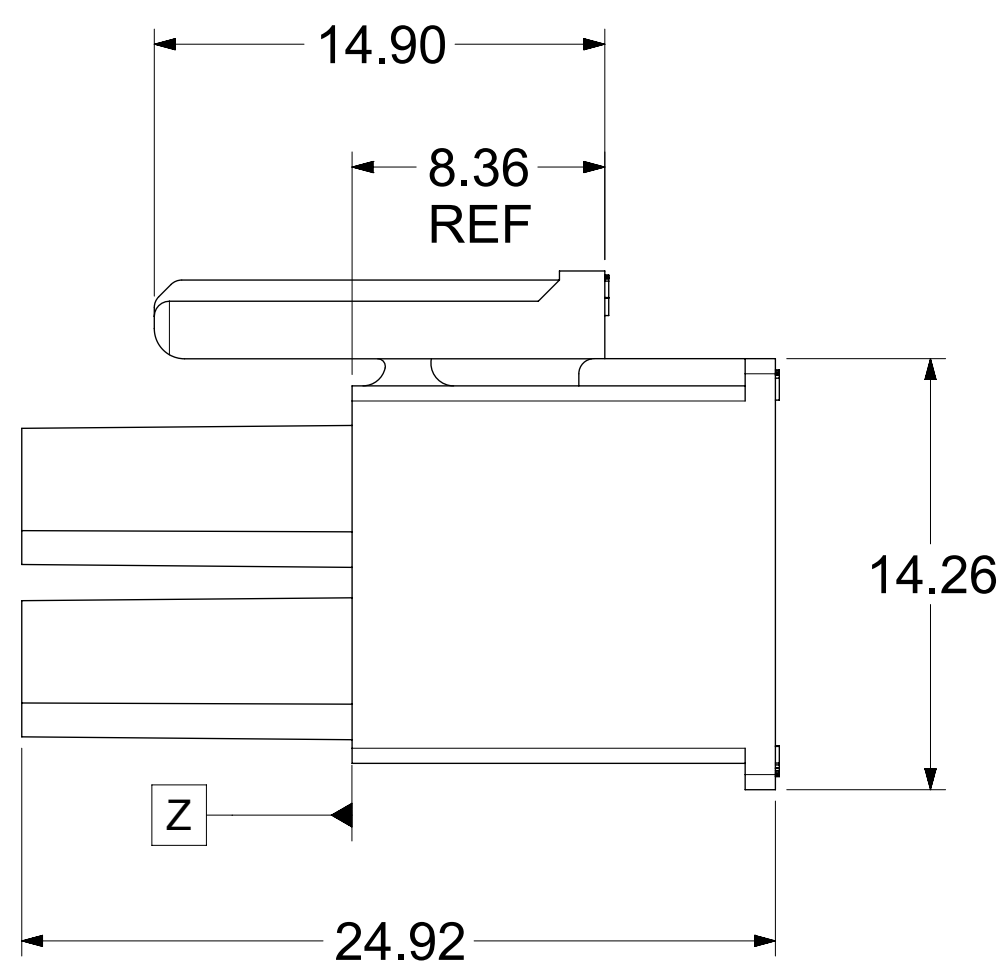
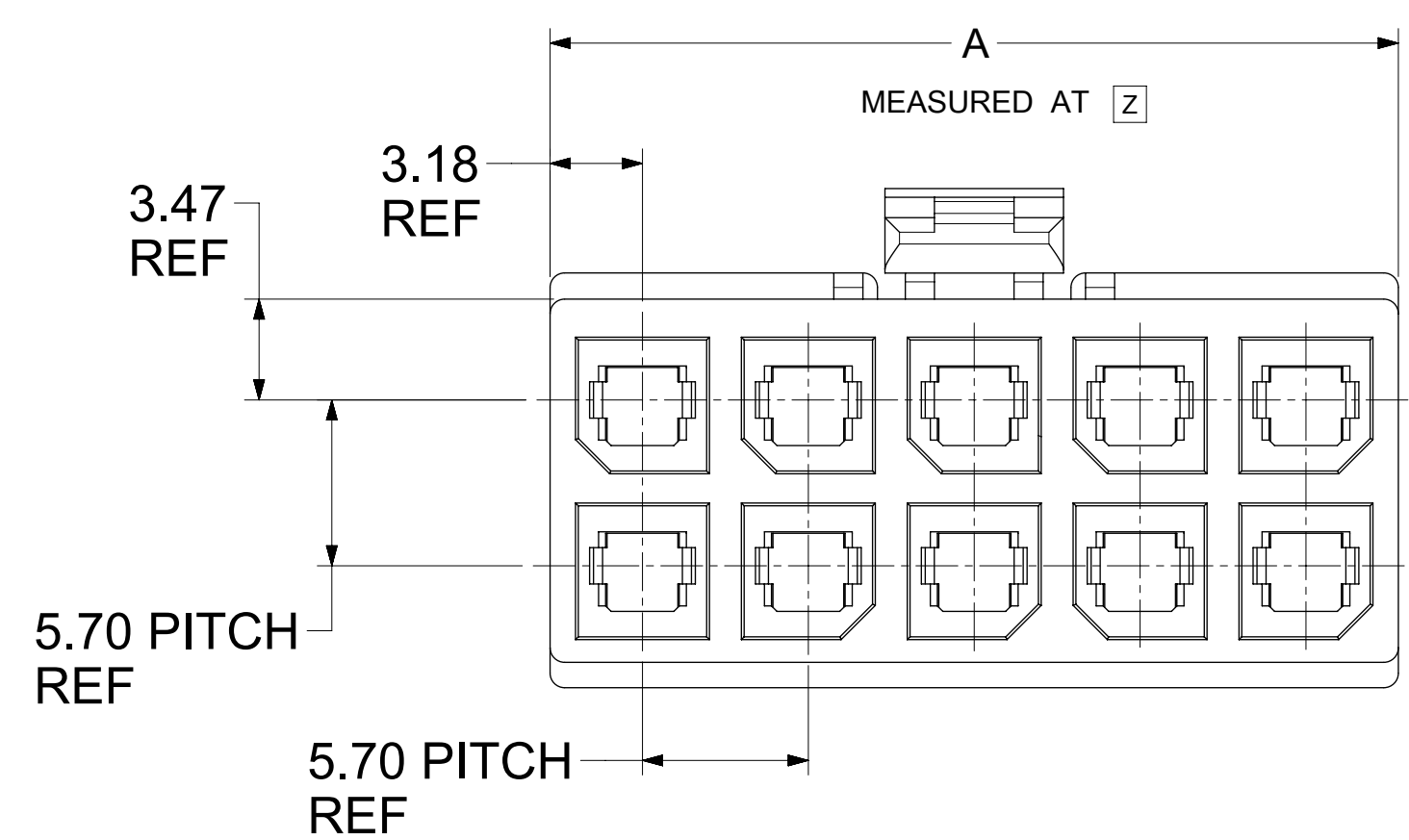

CKT NO	PART NO	DIM A
2	171692-0102	8.35
4	171692-0104	12.05
6	171692-0106	17.75
8	171692-0108	23.45±0.40
10	171692-0110	29.15±0.40
12	171692-0112	34.85±0.40

NOTES:

- MATERIAL:
HOUSING: PBT, UL 94V-0, COLOR: BLACK.
- FINISH: NOT APPLICABLE.
- PRODUCT SPECIFICATION: PS-76823-100.
- PACKAGING: BULK PACK PER PK-170001-001
- PART MATES WITH MOLEX SERIES NUMBERS 76825, 76829, 172064, AND 172065.
- PART IS FOR USE WITH MOLEX FEMALE TERMINAL 76823-032X OR 172063-031X OR 172063-131X SERIES.
- APPLICATION SPECIFICATION: AS-76823-100.

THIS DRAWING CONTAINS INFORMATION THAT IS PROPRIETARY TO MOLEX ELECTRONIC TECHNOLOGIES, LLC AND SHOULD NOT BE USED WITHOUT WRITTEN PERMISSION											
DIMENSION UNITS		SCALE		CURRENT REV DESC:							
mm		NTS									
GENERAL TOLERANCES (UNLESS SPECIFIED)				EC NO: 755658						DOCUMENT NUMBER	
ANGULAR TOL ± 0.5°				DRWN: WYATTH5 2023/07/04						DOC TYPE	
4 PLACES ±				CHK'D: XQZHANG 2023/07/24						DOC PART	
3 PLACES ±				APPR: XQZHANG 2023/07/24						REVISION	
2 PLACES ± 0.25				INITIAL REVISION:						SD-171692-0100	
1 PLACE ±				DRWN: MKARADIMAS 2012/08/01						PSD	
0 PLACES ±				APPR: APATEL 2012/08/17						001	
DRAFT WHERE APPLICABLE MUST REMAIN WITHIN DIMENSIONS				THIRD ANGLE PROJECTION		DRAWING		SERIES		SHEET NUMBER	
						D-SIZE		171692		1 OF 2	
						SEE CHART		GENERAL MARKET			

2 CKTS

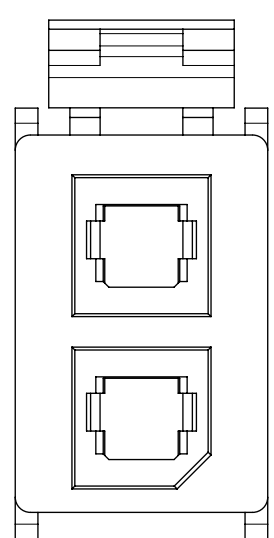

4 CKT

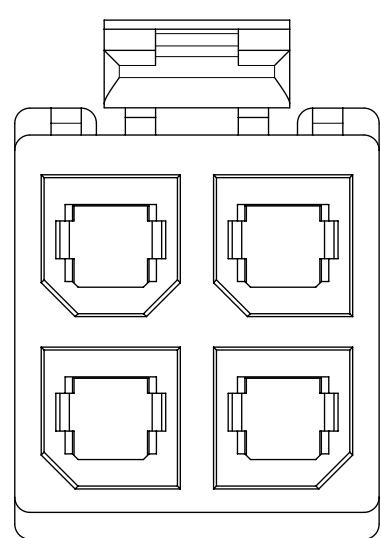

6 CKT

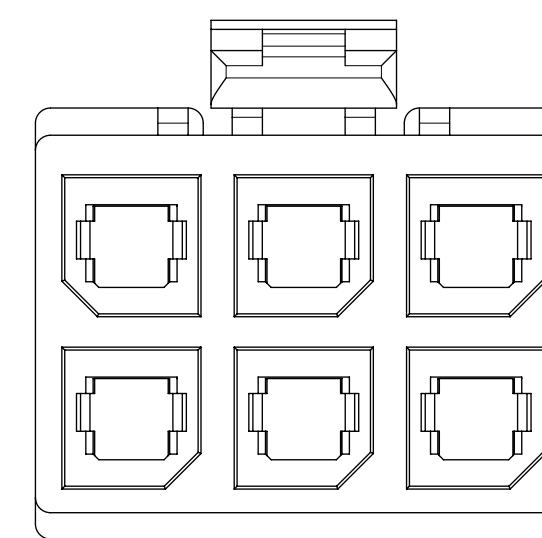

8 CKT

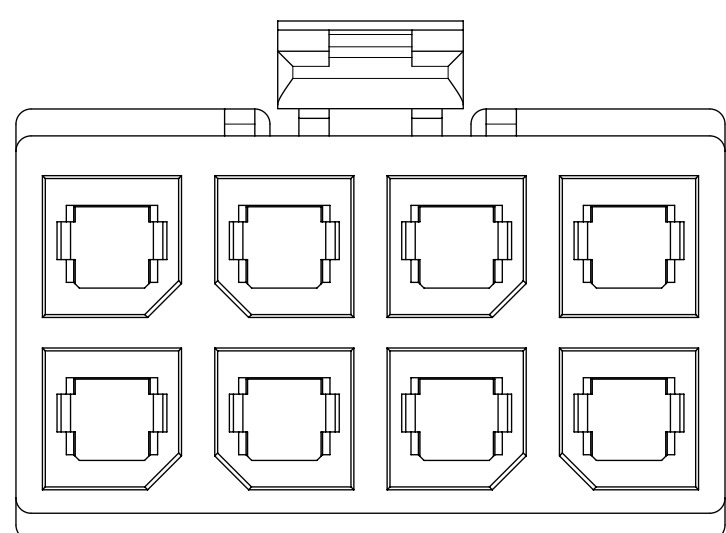

10 CKTS

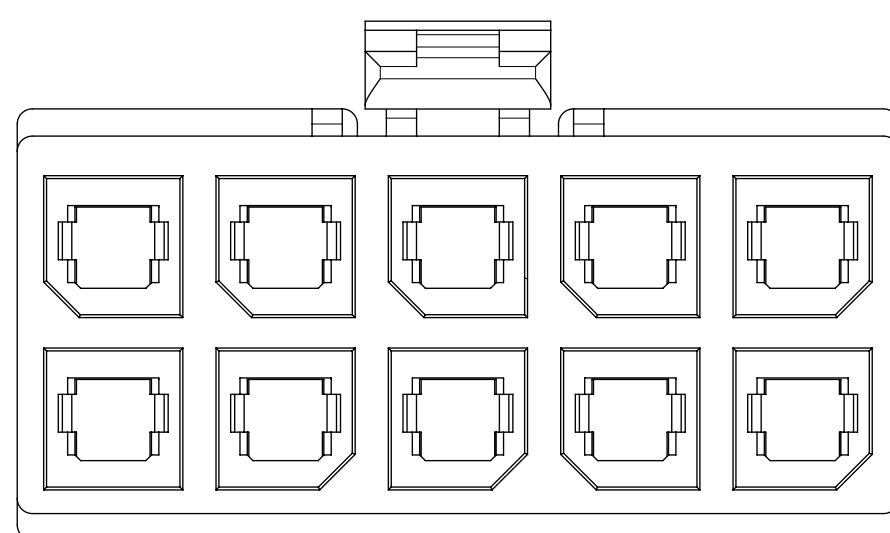

12 CKTS

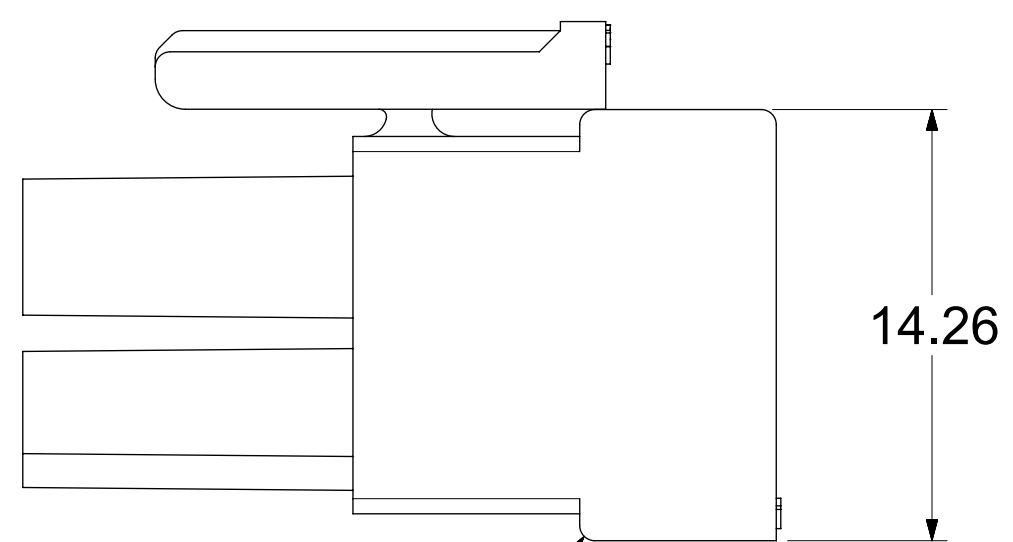
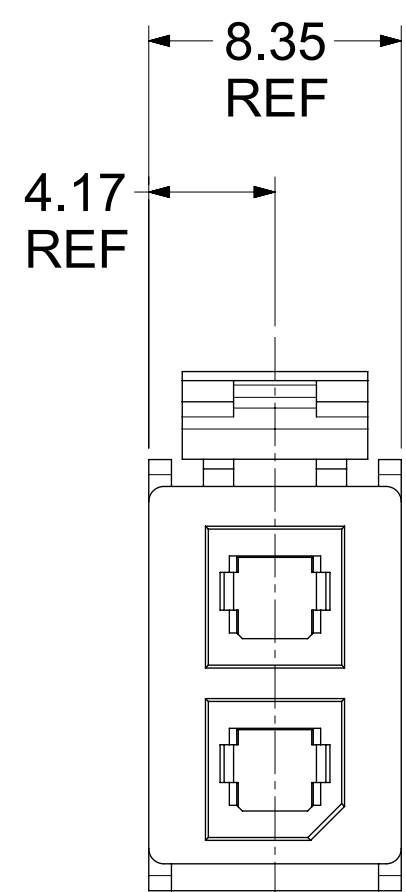
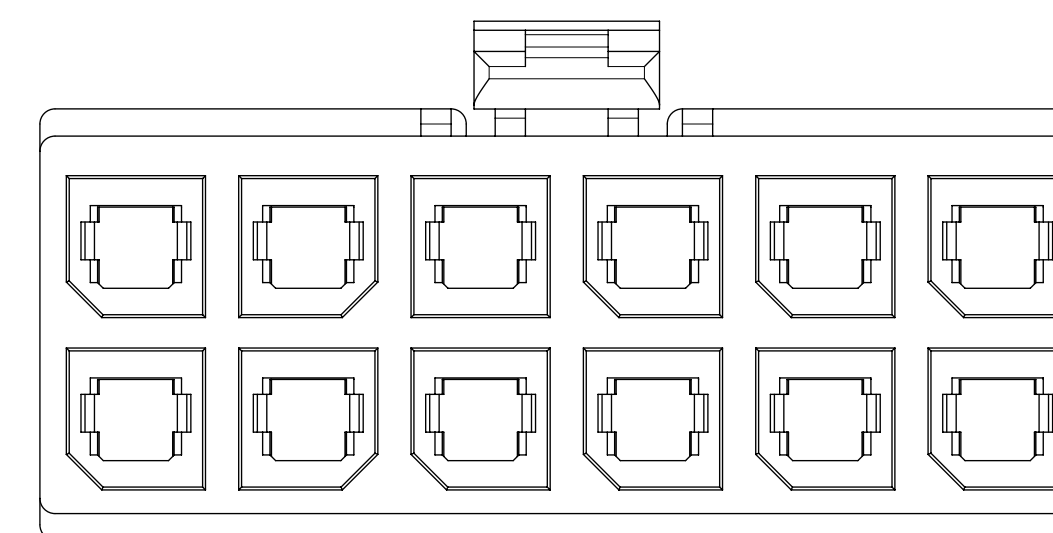

BOTTOM RIB ON
2 CKT ONLY

171692-0102

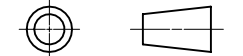
THIS DRAWING CONTAINS INFORMATION THAT IS PROPRIETARY TO MOLEX ELECTRONIC TECHNOLOGIES, LLC AND SHOULD NOT BE USED WITHOUT WRITTEN PERMISSION													
DIMENSION UNITS		SCALE		CURRENT REV DESC:									
mm		NTS											
GENERAL TOLERANCES (UNLESS SPECIFIED)				EC NO: 755658		2023/07/04		MEGA-FIT RECEPTACLE HOUSING 2-12 CKT					
ANGULAR TOL ± 0.5°				DRWN: WYATTH5		2023/07/24							
4 PLACES ±				CHK'D: XQZHANG		2023/07/24		PRODUCT CUSTOMER DRAWING					
3 PLACES ±				APPR: XQZHANG		2023/07/24							
2 PLACES ± 0.25				INITIAL REVISION:				DOCUMENT NUMBER					
1 PLACE ±				DRWN: MKARADIMAS		2012/08/01						SD-171692-0100	
0 PLACES ±				APPR: APATEL		2012/08/17		DOC TYPE					
DRAFT WHERE APPLICABLE MUST REMAIN WITHIN DIMENSIONS				THIRD ANGLE PROJECTION		DRAWING						SERIES	
						D-SIZE		171692		PSD		001 C2	
						SEE CHART		GENERAL MARKET		SHEET NUMBER		2 OF 2	