

4 CKT SHOWN

NOTES:

- 1) MATERIAL:
  - 225S = NYLON 6, UL94V-2, GLOW WIRE MATERIAL COLOR: BLACK
  - 225NS = NYLON 6, UL94V-2, GLOW WIRE MATERIAL COLOR: NATURAL
  - 250RS = NYLON 6/6, UL94V-0, GLOW WIRE MATERIAL COLOR: RED
  - 250GS = NYLON 6/6, UL94V-0, GLOW WIRE MATERIAL COLOR: GREEN
  - 250BS = NYLON 6/6, UL94V-0, GLOW WIRE MATERIAL COLOR: BLUE
  - 250WS = NYLON 6/6, UL94V-0, GLOW WIRE MATERIAL COLOR: NATURAL
- 2) FINISH: NOT APPLICABLE
- 3) PRODUCT SPECIFICATION: PS-5556-001
- 4) PACKAGING: BULK
- 5) PART MATES WITH MOLEX PLUG #46993 AND HEADERS #172447, #172448.
- 6) PART TO BE USED WITH MOLEX FEMALE TERMINAL #5556, #45750, #46018.
- 7) PART IS NOT DESIGNED FOR CURRENT SHARING.
- 8) CONNECTORS ARE NOT TO BE MATED OR UNMATED WHILE CIRCUITS ARE LIVE.
- 9) WIRES ARE TO BE DRESSED IN SUCH A MANNER TO ALLOW THE TERMINALS TO FLOAT FREELY IN THE POCKET.
- 10) PART CONFORMS TO CLASS "B" REQUIREMENTS OF COSMETIC SPECIFICATION PS-45499-002 WITH THE EXCEPTION OF DISCOLORATION, FLASH AND SINK MEET CLASS "C" REQUIREMENTS.
  - △ TO BE MEASURED AT SURFACE Z
- 12) TEXT ON PART IS FOR REFERENCE ONLY. TEXT AND TEXT LOCATION MAY VARY DEPENDING ON PART NUMBER AND/OR TOOL.
- 13) APPLICATION SPECIFICATION :469920000-AS.
- 14) BUBBLE IS ACCEPTABLE ON LATCH AREA.

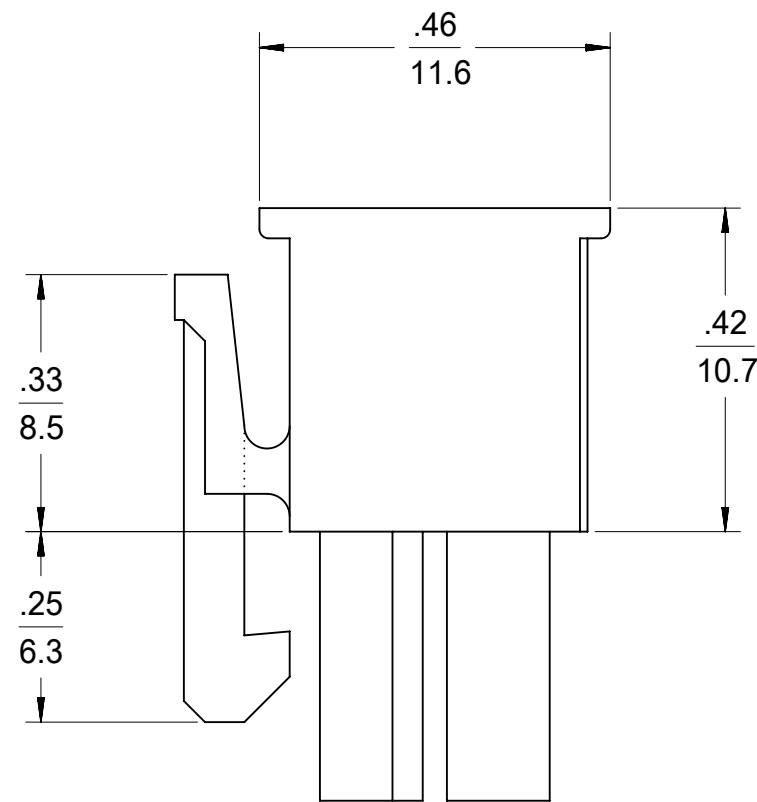
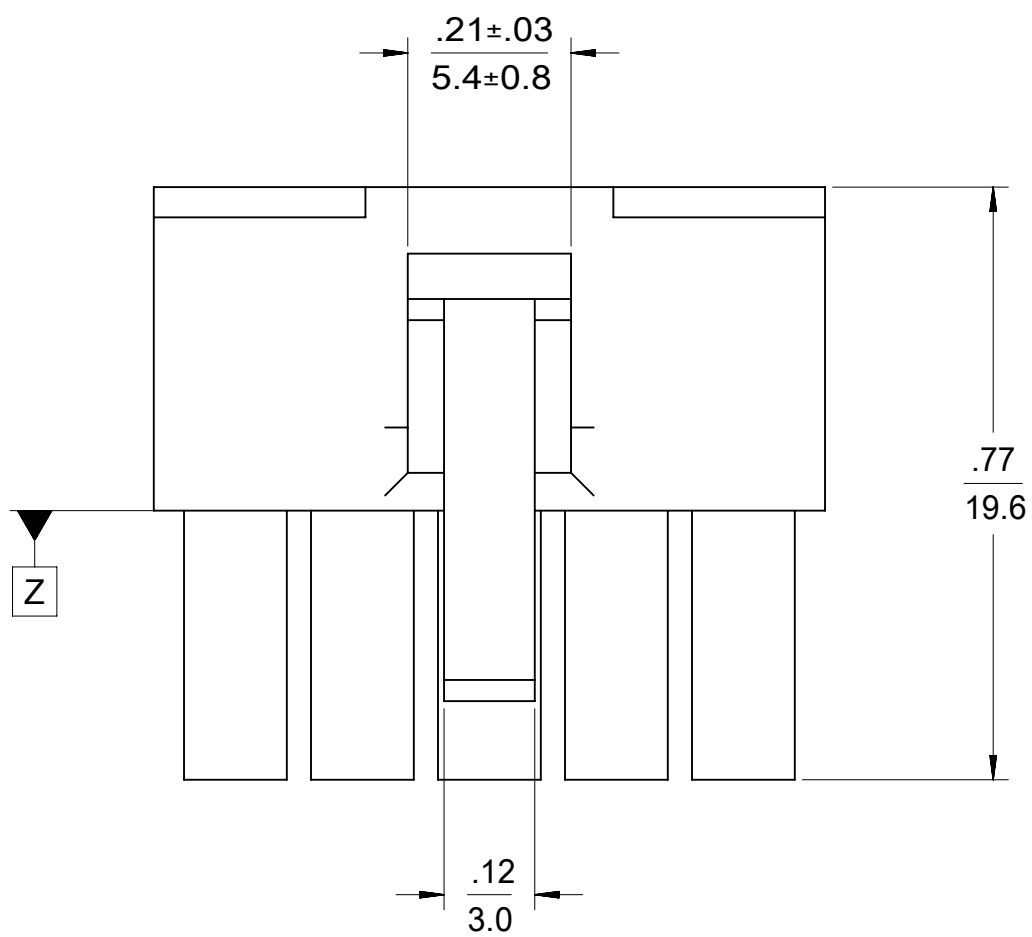

4-24 CKT

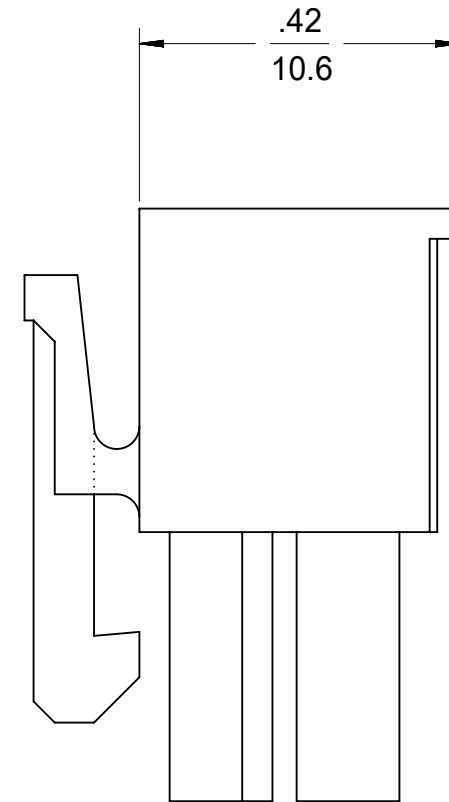

2 CKT ONLY

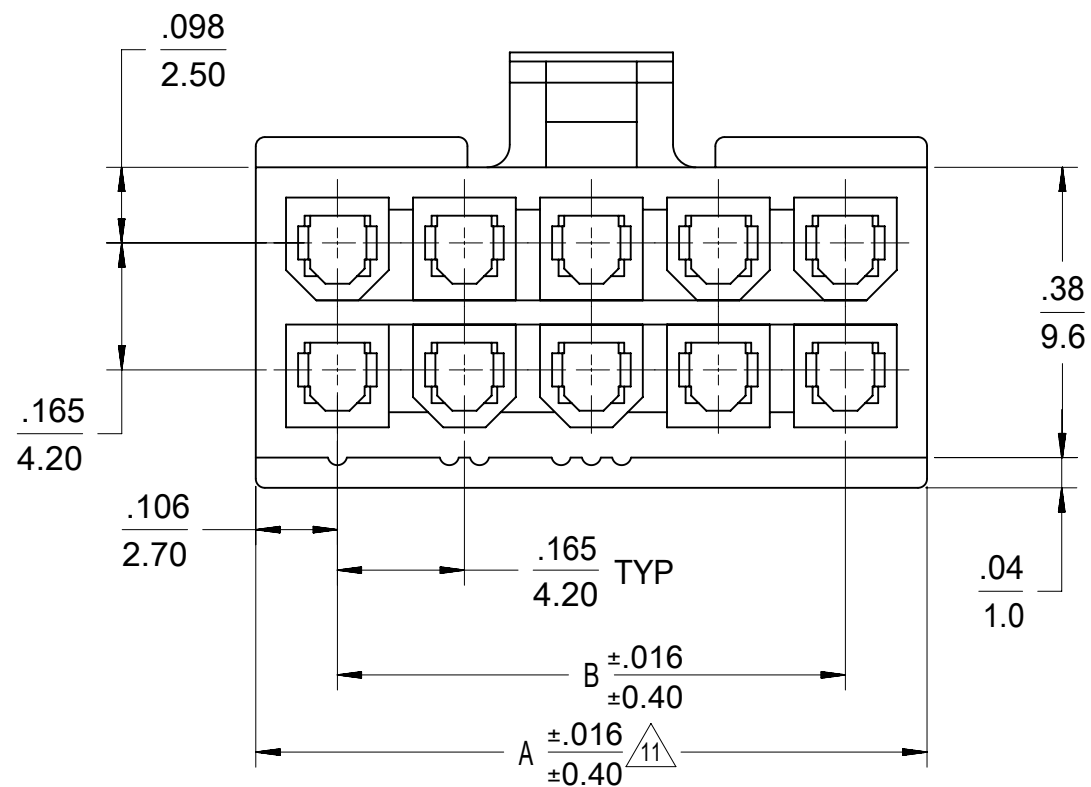

**LEGEND**

46992 -\*\*\* 0

CIRCUIT SIZE

MATERIAL (SEE NOTE 1)

- 0 = 225NS
- 1 = 225S
- 2 = 250RS
- 3 = 250GS
- 4 = 250BS
- 5 = 250WS

CONFIGURATION DUAL ROW

THIS DRAWING CONTAINS INFORMATION THAT IS PROPRIETARY TO MOLEX ELECTRONIC TECHNOLOGIES, LLC AND SHOULD NOT BE USED WITHOUT WRITTEN PERMISSION									
DIMENSION UNITS		SCALE		CURRENT REV DESC:					
mm		NTS							
GENERAL TOLERANCES (UNLESS SPECIFIED)				EC NO: 776137		2024/02/01		MINIFIT JR	
				DRWN: JERRYW8		2024/02/22		RECEPTACLE HOUSING DUAL ROW, 2-24 CKT	
4 PLACES ±				CHK'D: XQZHANG		2024/02/22		PRODUCT CUSTOMER DRAWING	
3 PLACES ±				APPR: XQZHANG		2024/02/22		DOCUMENT NUMBER	
2 PLACES ± 0.25 ± 0.015				INITIAL REVISION:				DOC TYPE   DOC PART   REVISION	
1 PLACE ± 0.38 ±				DRWN: NNGUYEN		2013/04/12		SD-46992-0000	
0 PLACES ±				APPR: FSMITH		2014/05/16		PSD 000 A10	
ANGULAR TOL ± 3.0 °				THIRD ANGLE PROJECTION		DRAWING		MATERIAL NUMBER	
DRAFT WHERE APPLICABLE MUST REMAIN WITHIN DIMENSIONS				C-SIZE		SERIES		CUSTOMER	
				46992		GENERAL MARKET		SHEET NUMBER	
								1 OF 2	



2 CKT.



14 CKT.

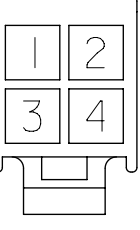

4 CKT.

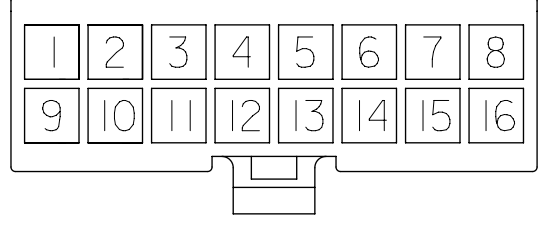

16 CKT.

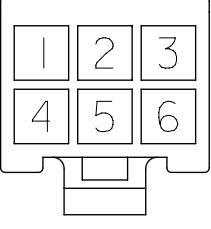

6 CKT.

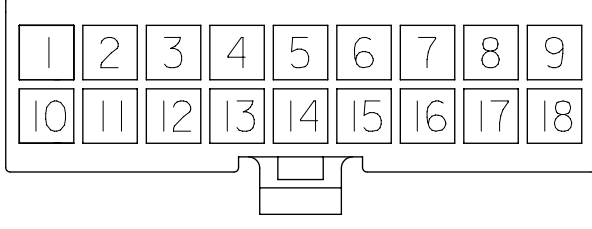

18 CKT.

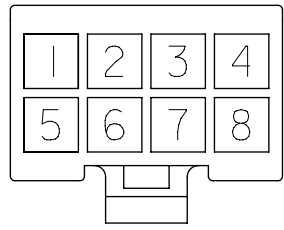

8 CKT.

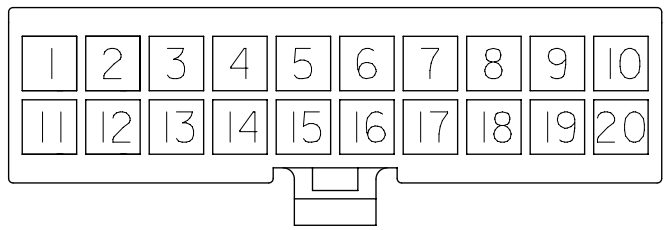

20 CKT.

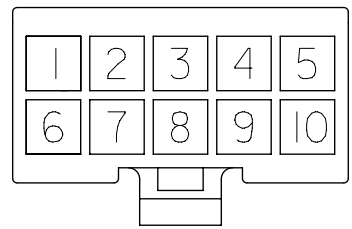

10 CKT.

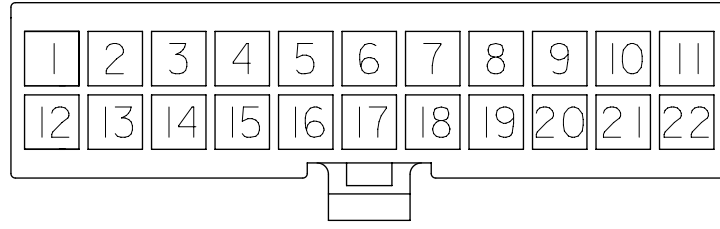

22 CKT.

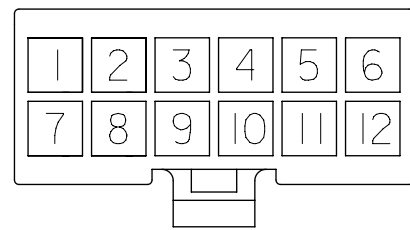

12 CKT.

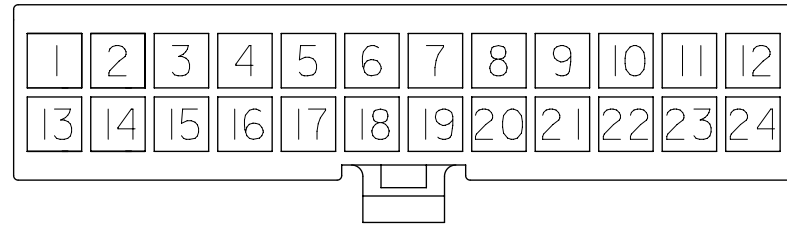

24 CKT.

**CIRCUIT SIZE LAYOUT  
(NOT TO SCALE)**

PART NUMBER	CKT SIZE	DIM "A"	DIM "B"	MATERIAL CODE & COLOR
46992-0240	02	.21/5.40	--	250BS BLUE (V0)
46992-0440	04	.38/9.60	.165/4.20	
46992-0640	06	.54/13.8	.331/8.40	
46992-0840	08	.71/18.0	.496/12.60	
46992-1040	10	.87/22.2	.661/16.8	
46992-1240	12	1.04/26.4	.827/21.00	
46992-0250	02	.21/5.40	--	250WS NATURAL (V0)
46992-0450	04	.38/9.60	.165/4.20	
46992-0650	06	.54/13.8	.331/8.40	
46992-0850	08	.71/18.0	.496/12.60	
46992-1050	10	.87/22.2	.661/16.8	
46992-1250	12	1.04/26.4	.827/21.00	

PART NUMBER	CKT SIZE	DIM "A"	DIM "B"	MATERIAL CODE & COLOR
46992-0200	02	.21/5.40	--	225NS NATURAL (V2)
46992-0400	04	.38/9.60	.165/4.20	
46992-0600	06	.54/13.8	.331/8.40	
46992-0800	08	.71/18.0	.496/12.60	
46992-1000	10	.87/22.2	.661/16.8	
46992-1200	12	1.04/26.4	.827/21.00	
46992-1400	14	1.21 / 30.6	.992/25.20	
46992-1600	16	1.37 / 34.8	1.158/29.40	
46992-1800	18	1.54 / 39.0	1.323/33.60	
46992-2000	X 20	1.70 / 43.2	1.488/37.80	
46992-2200	X 22	1.87 / 47.4	1.654/42.00	
46992-2400	X 24	2.03 / 51.6	1.819/46.20	
46992-0210	02	.21/5.40	--	225S BLACK (V2)
46992-0410	04	.38/9.60	.165/4.20	
46992-0610	06	.54/13.8	.331/8.40	
46992-0810	08	.71/18.0	.496/12.60	
46992-1010	10	.87/22.2	.661/16.8	
46992-1210	12	1.04/26.4	.827/21.00	
46992-1410	14	1.21 / 30.6	.992/25.20	
46992-1610	16	1.37 / 34.8	1.158/29.40	
46992-1810	18	1.54 / 39.0	1.323/33.60	
46992-2010	X 20	1.70 / 43.2	1.488/37.80	
46992-2210	X 22	1.87 / 47.4	1.654/42.00	
46992-2410	24	2.03 / 51.6	1.819/46.20	
46992-0220	02	.21/5.40	--	250RS RED (V0)
46992-0420	04	.38/9.60	.165/4.20	
46992-0620	06	.54/13.8	.331/8.40	
46992-0820	08	.71/18.0	.496/12.60	
46992-1020	10	.87/22.2	.661/16.8	
46992-1220	12	1.04/26.4	.827/21.00	
46992-0230	02	.21/5.40	--	250GS GREEN (V0)
46992-0430	04	.38/9.60	.165/4.20	
46992-0630	06	.54/13.8	.331/8.40	
46992-0830	08	.71/18.0	.496/12.60	
46992-1030	10	.87/22.2	.661/16.8	
46992-1230	12	1.04/26.4	.827/21.00	

X = NOT TOOLED

THIS DRAWING CONTAINS INFORMATION THAT IS PROPRIETARY TO MOLEX ELECTRONIC TECHNOLOGIES, LLC AND SHOULD NOT BE USED WITHOUT WRITTEN PERMISSION

DIMENSION UNITS		SCALE		CURRENT REV DESC:					
mm		NTS							
GENERAL TOLERANCES (UNLESS SPECIFIED)						<b>MINIFIT JR</b> RECEPTACLE HOUSING DUAL ROW, 2-24 CKT  PRODUCT CUSTOMER DRAWING  DOCUMENT NUMBER: <b>SD-46992-0000</b>   DOC TYPE: PSD   DOC PART: 000   REVISION: A10  MATERIAL NUMBER: SEE TABLE   CUSTOMER: GENERAL MARKET   SHEET NUMBER: 2 OF 2			
		MM	INCH						
4 PLACES	±		±						
3 PLACES	±		± 0.01						
2 PLACES	±	0.25	± 0.015						
1 PLACE	±	0.38	±						
0 PLACES	±		±						
ANGULAR TOL		± 3.0 °							
DRAFT WHERE APPLICABLE MUST REMAIN WITHIN DIMENSIONS		THIRD ANGLE PROJECTION		DRAWING SERIES					
				C-SIZE 46992					

EC NO: 776137  
DRWN: JERRYW8 2024/02/01  
CHK'D: XQZHANG 2024/02/22  
APPR: XQZHANG 2024/02/22  
INITIAL REVISION:  
DRWN: NNGUYEN 2013/04/12  
APPR: FSMITH 2014/05/16