

171692-0110

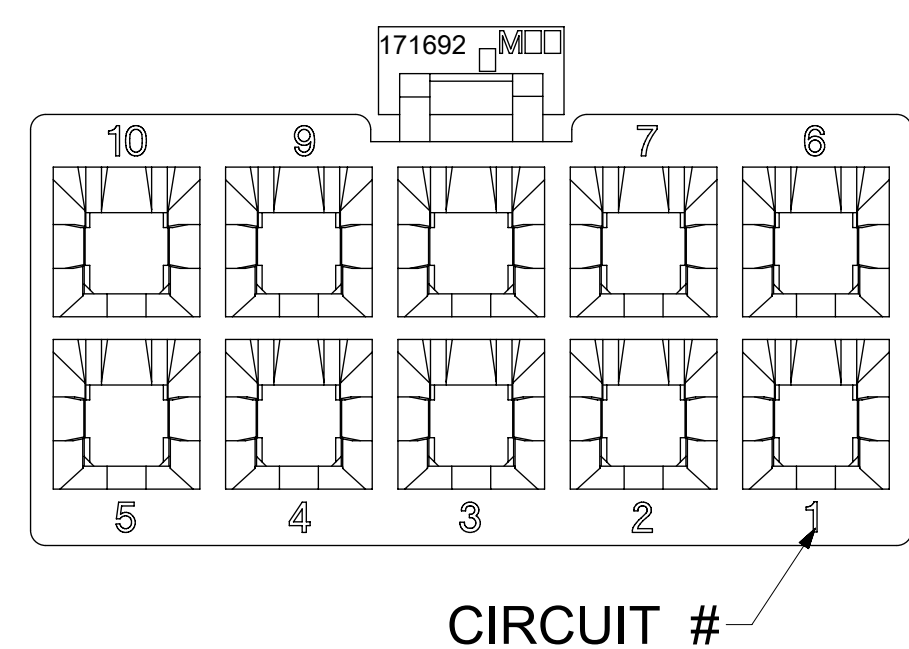
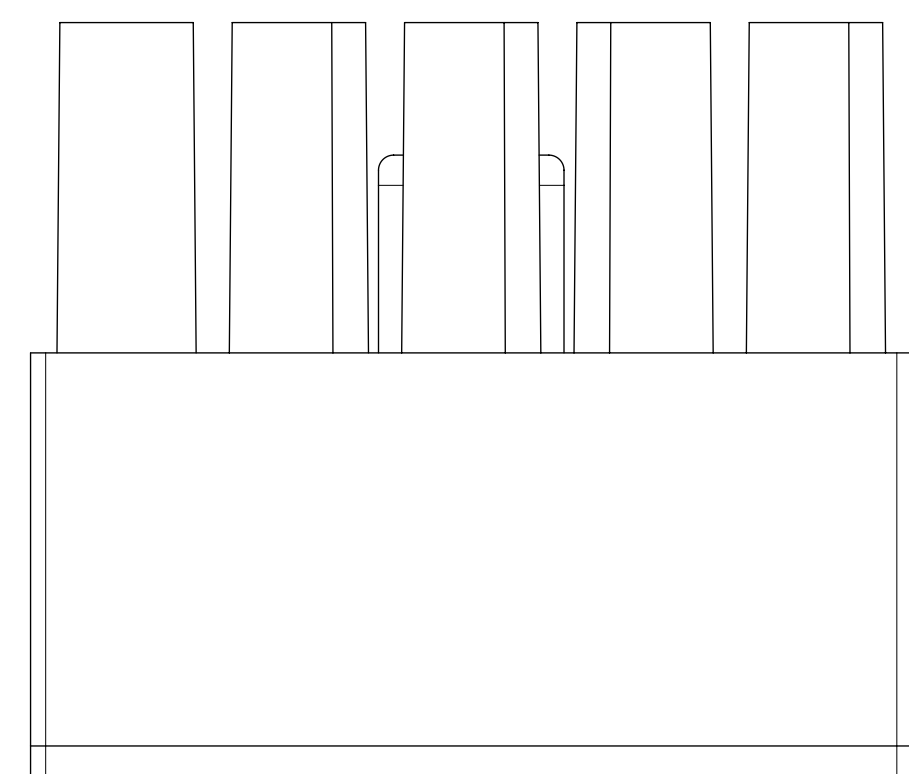
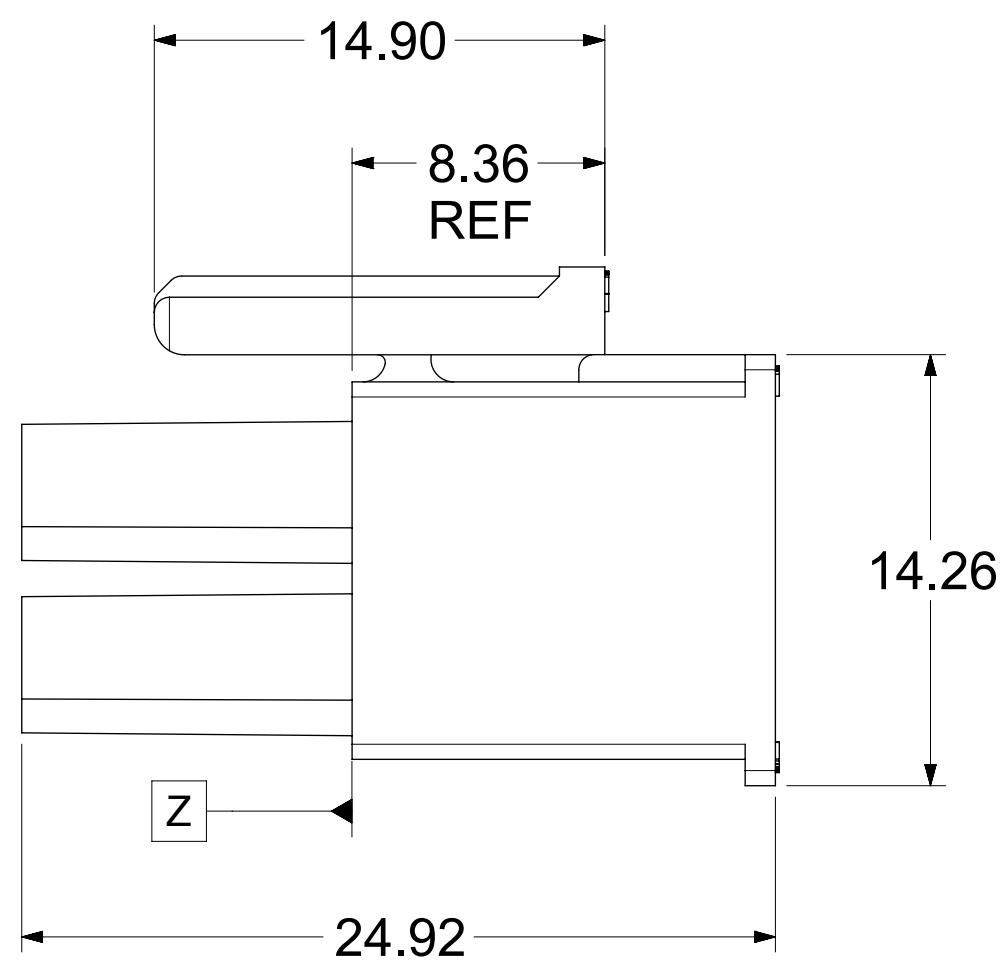
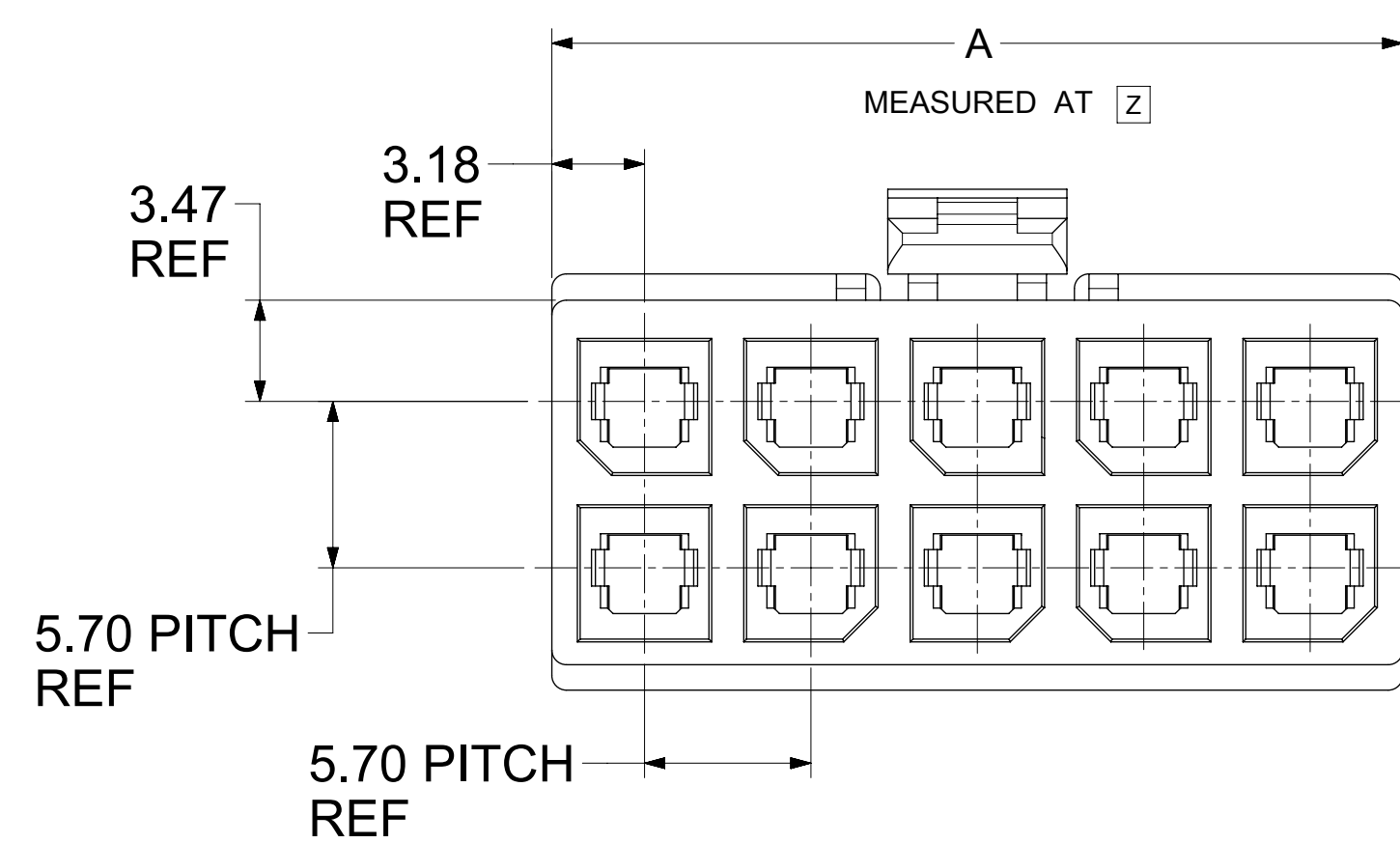

CKT NO	PART NO	DIM A
2	171692-0102	8.35
4	171692-0104	12.05
6	171692-0106	17.75
8	171692-0108	23.45±0.40
10	171692-0110	29.15±0.40
12	171692-0112	34.85±0.40

NOTES:

- MATERIAL:
HOUSING: PBT, UL 94V-0, COLOR: BLACK.
- FINISH: NOT APPLICABLE.
- PRODUCT SPECIFICATION: PS-76823-100.
- PACKAGING: BULK PACK PER PK-170001-001
- PART MATES WITH MOLEX SERIES NUMBERS 76825, 76829, 172064, AND 172065.
- PART IS FOR USE WITH MOLEX FEMALE TERMINAL 76823-032X OR 172063-031X OR 172063-131X SERIES.
- APPLICATION SPECIFICATION: AS-76823-100.

THIS DRAWING CONTAINS INFORMATION THAT IS PROPRIETARY TO MOLEX ELECTRONIC TECHNOLOGIES, LLC AND SHOULD NOT BE USED WITHOUT WRITTEN PERMISSION		CURRENT REV DESC:			
DIMENSION UNITS	SCALE	EC NO: 755658			
mm	NTS	DRWN: WYATTH5 2023/07/04		MEGA-FIT RECEPTACLE HOUSING 2-12 CKT	
GENERAL TOLERANCES (UNLESS SPECIFIED)		CHK'D: XQZHANG 2023/07/24			
ANGULAR TOL ± 0.5°		APPR: XQZHANG 2023/07/24		PRODUCT CUSTOMER DRAWING	
4 PLACES ±		INITIAL REVISION:		DOCUMENT NUMBER	
3 PLACES ±		DRWN: MKARADIMAS 2012/08/01		SD-171692-0100	
2 PLACES ± 0.25		APPR: APATEL 2012/08/17		DOC TYPE DOC PART REVISION	
1 PLACE ±		DRAFT WHERE APPLICABLE MUST REMAIN WITHIN DIMENSIONS		PSD 001 C2	
0 PLACES ±		THIRD ANGLE PROJECTION		MATERIAL NUMBER CUSTOMER	
DRAFT WHERE APPLICABLE MUST REMAIN WITHIN DIMENSIONS		DRAWING SERIES		SEE CHART GENERAL MARKET	
		D-SIZE 171692		SHEET NUMBER	
				1 OF 2	

2 CKTS

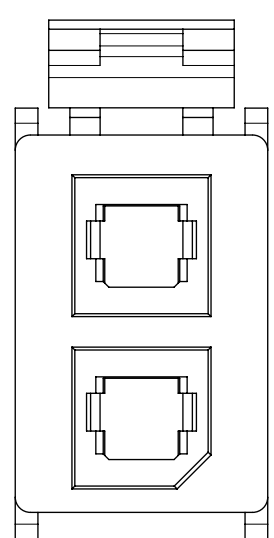

4 CKT

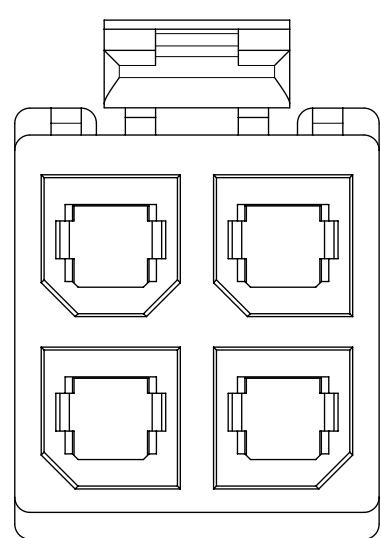

6 CKT

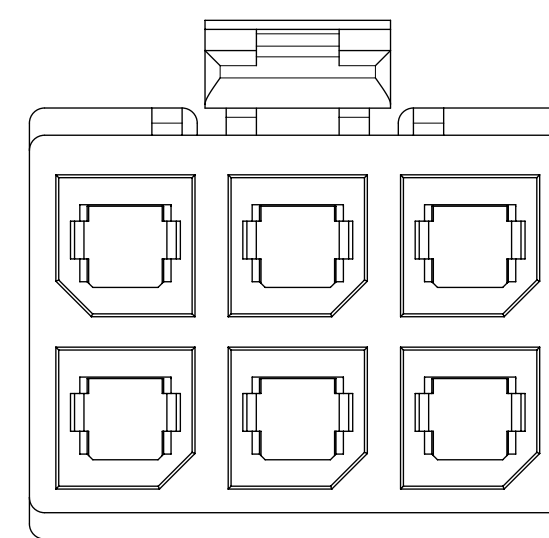

8 CKT

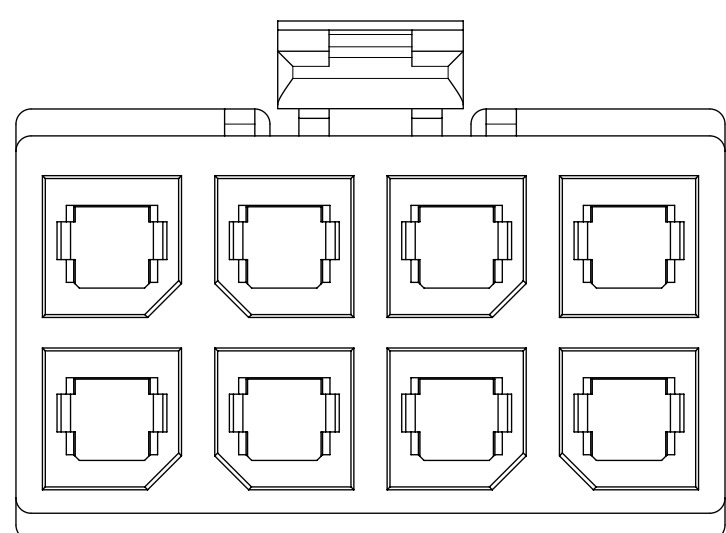

10 CKTS

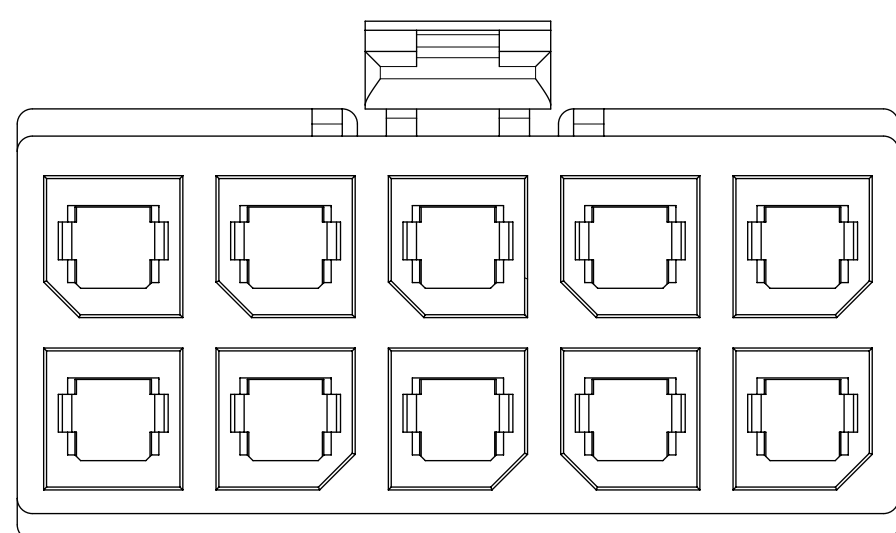

12 CKTS

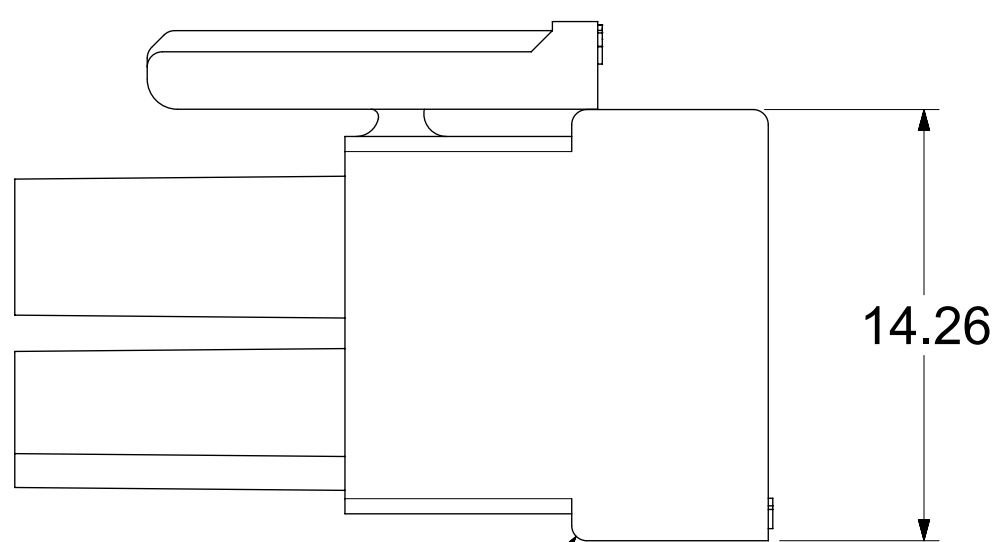
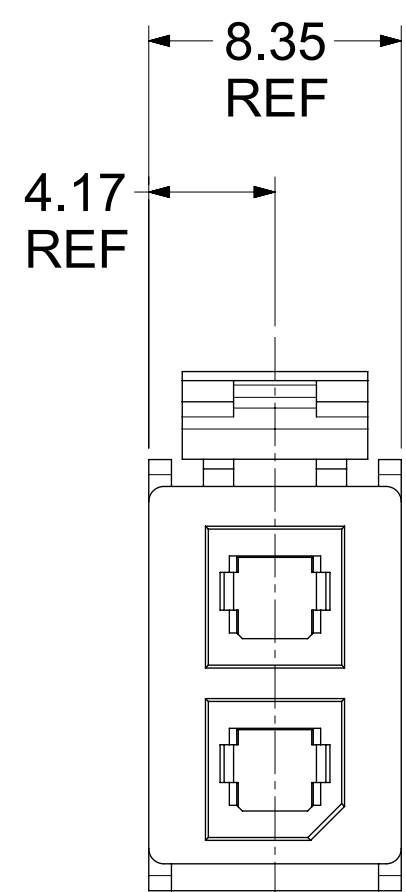
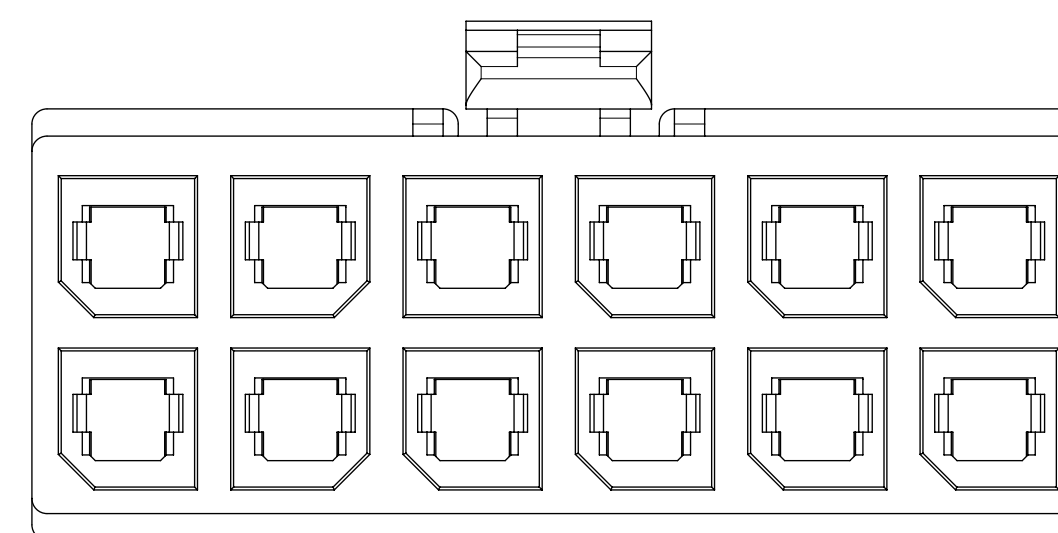

BOTTOM RIB ON
2 CKT ONLY

171692-0102

THIS DRAWING CONTAINS INFORMATION THAT IS PROPRIETARY TO MOLEX ELECTRONIC TECHNOLOGIES, LLC AND SHOULD NOT BE USED WITHOUT WRITTEN PERMISSION												
DIMENSION UNITS		SCALE		CURRENT REV DESC:						molex		
mm		NTS										
GENERAL TOLERANCES (UNLESS SPECIFIED)				EC NO: 755658		2023/07/04		MEGA-FIT RECEPTACLE HOUSING 2-12 CKT				
ANGULAR TOL ± 0.5°				DRWN: WYATTH5		2023/07/24						
4 PLACES ±				CHK'D: XQZHANG		2023/07/24		PRODUCT CUSTOMER DRAWING				
3 PLACES ±				APPR: XQZHANG		2023/07/24						
2 PLACES ± 0.25				INITIAL REVISION:				DOCUMENT NUMBER		DOC TYPE	DOC PART	REVISION
1 PLACE ±				DRWN: MKARADIMAS		2012/08/01		SD-171692-0100		PSD	001	C2
0 PLACES ±				APPR: APATEL		2012/08/17		MATERIAL NUMBER		CUSTOMER		SHEET NUMBER
DRAFT WHERE APPLICABLE MUST REMAIN WITHIN DIMENSIONS				THIRD ANGLE PROJECTION		DRAWING		SERIES		SEE CHART		GENERAL MARKET
				D-SIZE		171692						2 OF 2