

170001-0110

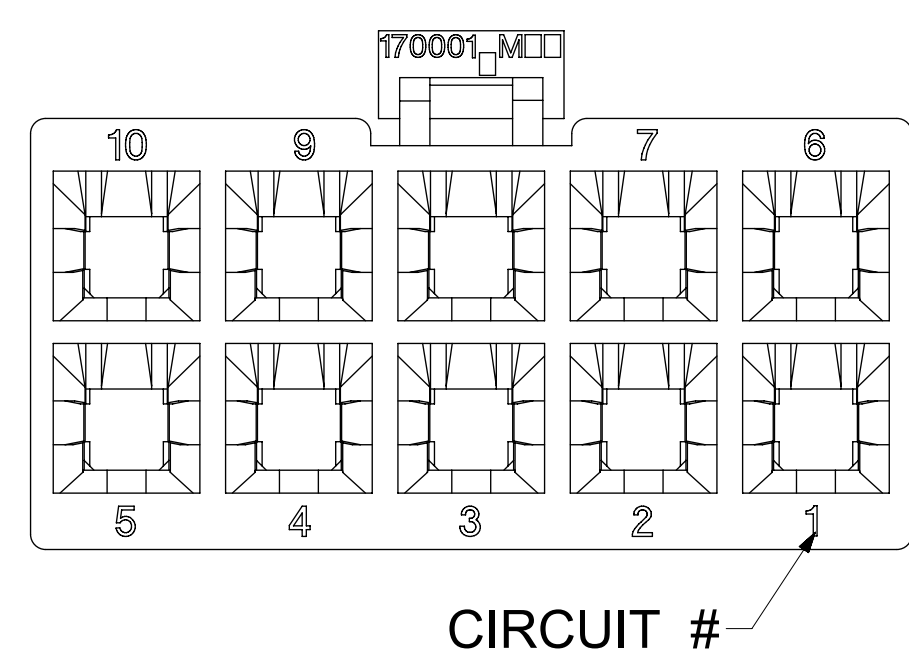
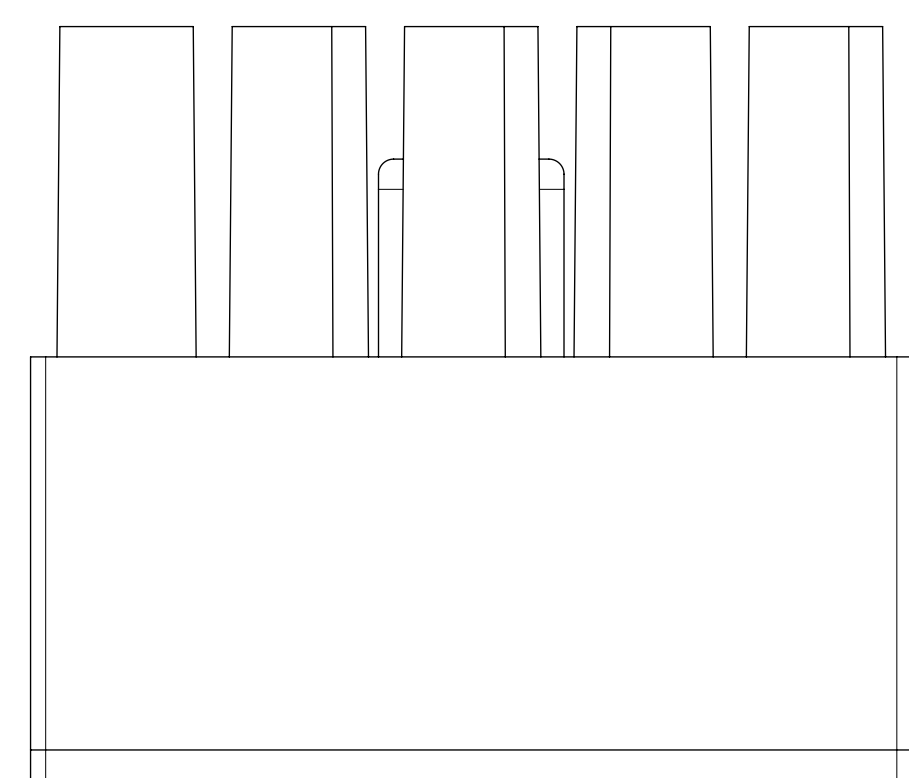
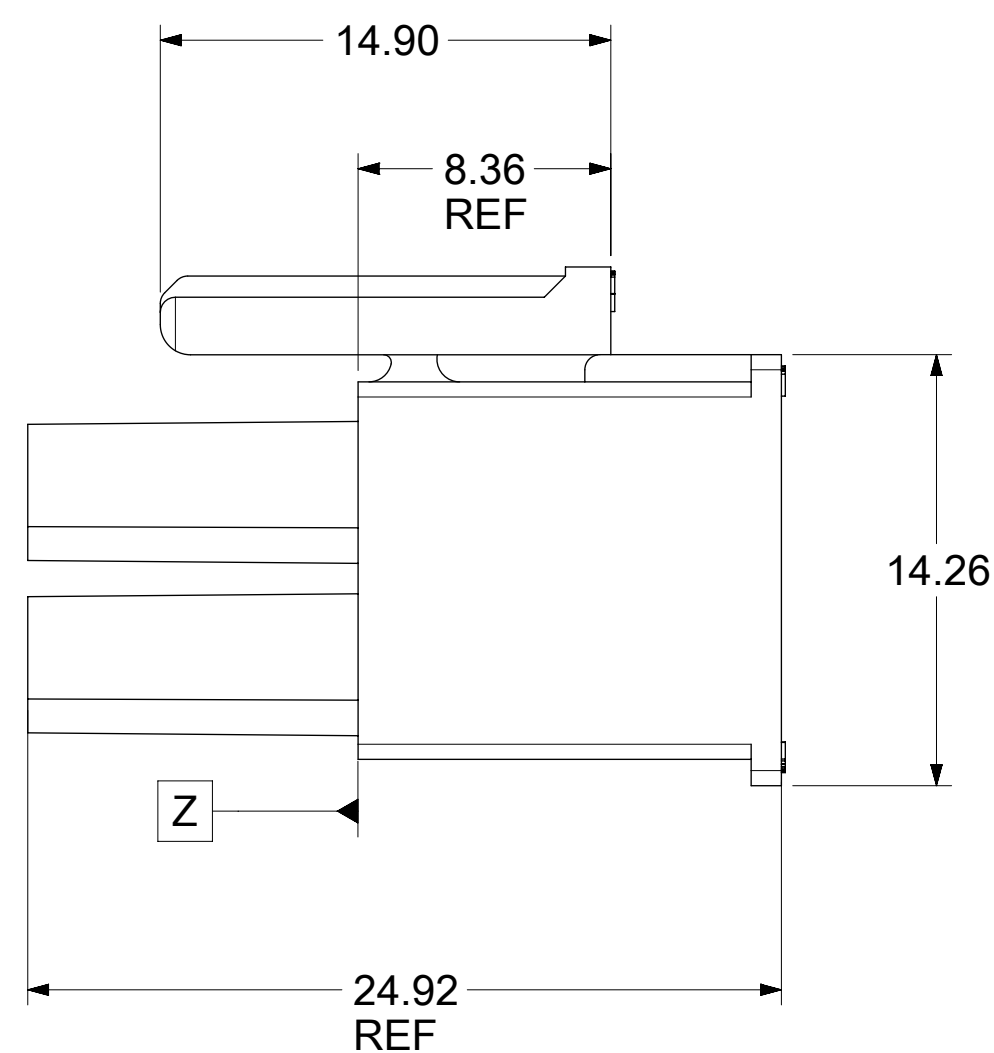
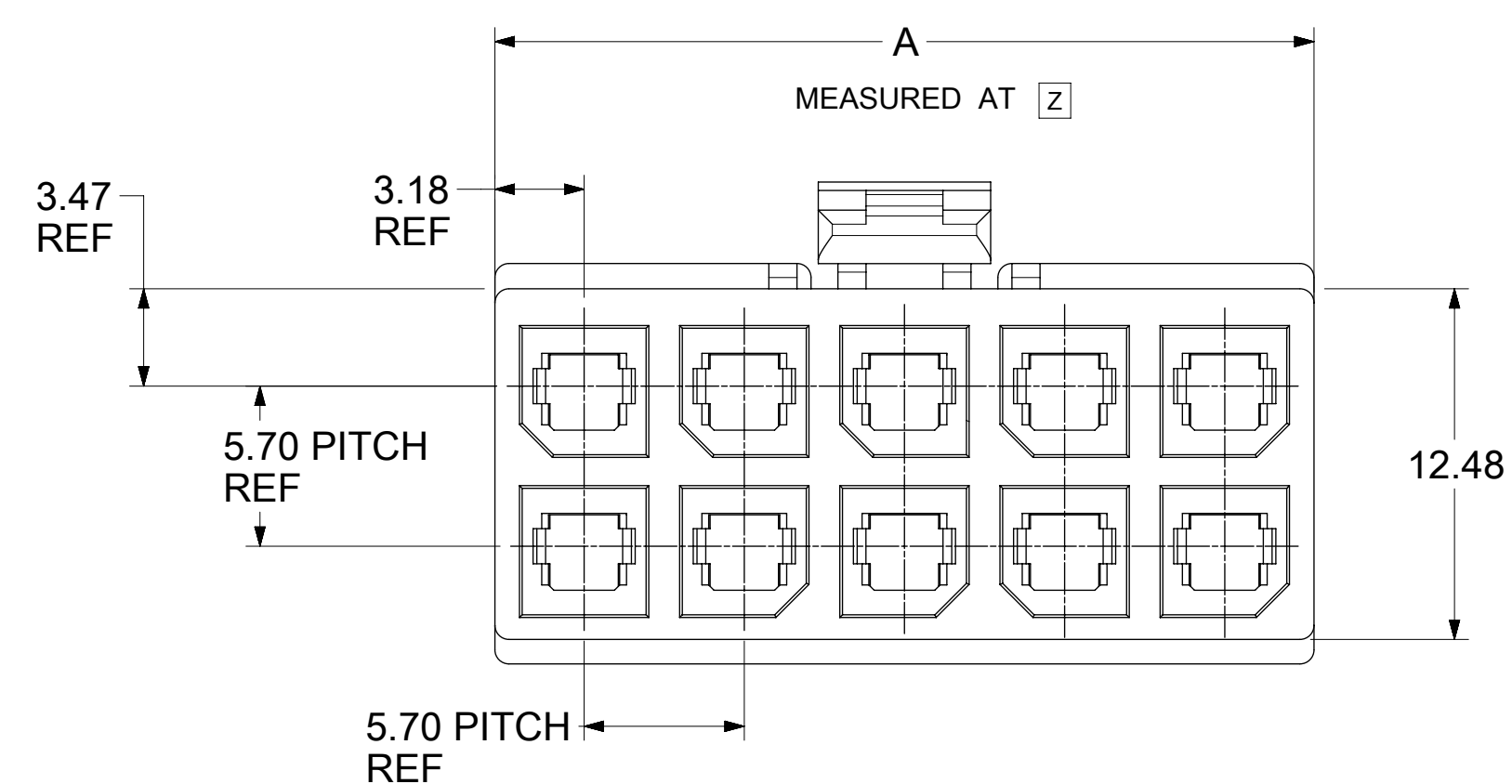

CKT NO	PART NO	DIM A
2	170001-0102	8.35
4	170001-0104	12.05
6	170001-0106	17.75
8	170001-0108	23.45±0.40
10	170001-0110	29.15±0.40
12	170001-0112	34.85±0.40

NOTES:

- MATERIAL:
HOUSING: NYLON, UL 94V-2, GLOW WIRE CAPABLE PER IEC-60335-1 5TH EDITION, COLOR: BLACK.
- FINISH: NOT APPLICABLE.
- PRODUCT SPECIFICATION: PS-76823-100.
- PACKAGING: BULK PACK PER PK-170001-001
- PART MATES WITH MOLEX SERIES NUMBERS 76825, 76829, 172064, AND 172065.
- PART IS FOR USE WITH MOLEX FEMALE TERMINAL 76823-032X OR 172063-031X OR 172063-131X SERIES.
- APPLICATION SPECIFICATION: AS-76823-100.

THIS DRAWING CONTAINS INFORMATION THAT IS PROPRIETARY TO MOLEX ELECTRONIC TECHNOLOGIES, LLC AND SHOULD NOT BE USED WITHOUT WRITTEN PERMISSION			
DIMENSION UNITS mm	SCALE NTS	CURRENT REV DESC:	
GENERAL TOLERANCES (UNLESS SPECIFIED)		<p>molex</p> <p>MEGA-FIT RECEPTACLE HOUSING 2-12 CKT GLOW WIRE</p> <p>PRODUCT CUSTOMER DRAWING</p>	
ANGULAR TOL	± 0.5°		
4 PLACES	±		
3 PLACES	±		
2 PLACES	± 0.25		
1 PLACE	±	EC NO: 755658 DRWN: WYATTH5 2023/06/21 CHK'D: XQZHANG 2023/07/24 APPR: XQZHANG 2023/07/24	
0 PLACES	±	INITIAL REVISION: DRWN: MKARADIMAS 2010/11/23 APPR: APATEL 2012/06/13	
DRAFT WHERE APPLICABLE MUST REMAIN WITHIN DIMENSIONS	THIRD ANGLE PROJECTION	DRAWING	SERIES
		D-SIZE	170001
		MATERIAL NUMBER	CUSTOMER
		SEE TABLE	GENERAL MARKET
		DOCUMENT NUMBER	DOC TYPE DOC PART REVISION
		SD-170001-0100	PSD 001 C
		SHEET NUMBER	
		1 OF 2	

2 CKTS

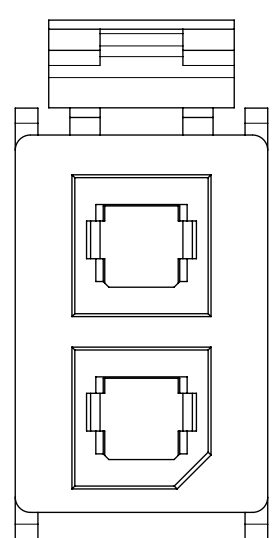

4 CKT

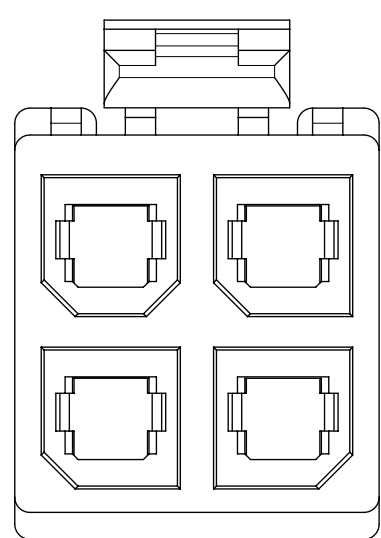

6 CKT

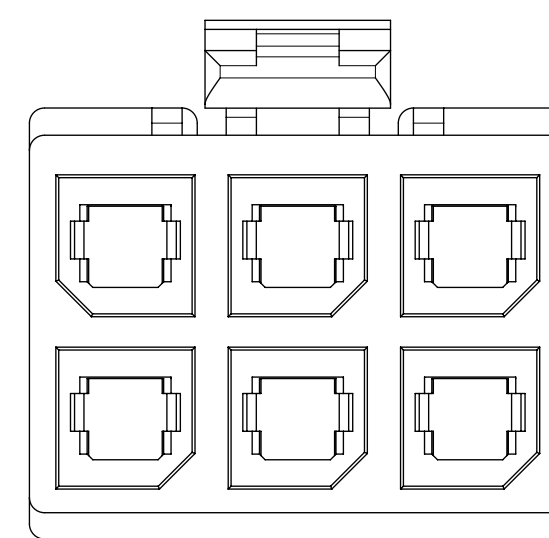

8 CKT

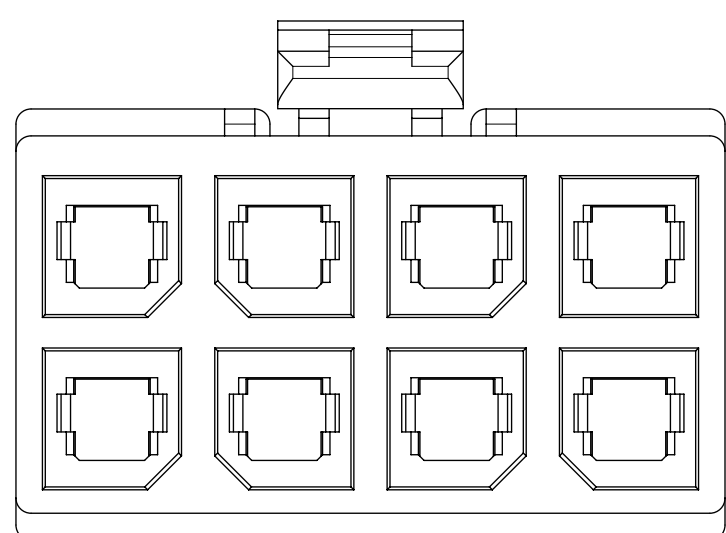

10 CKTS

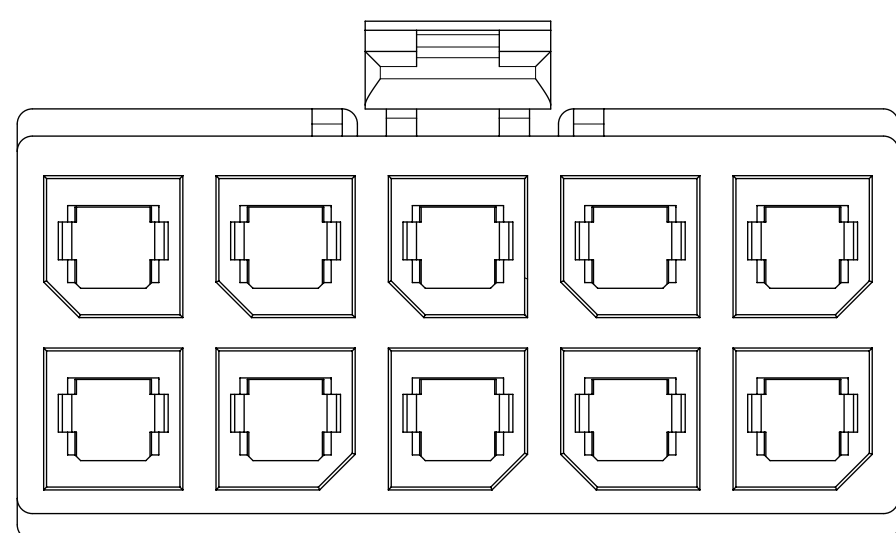

12 CKTS

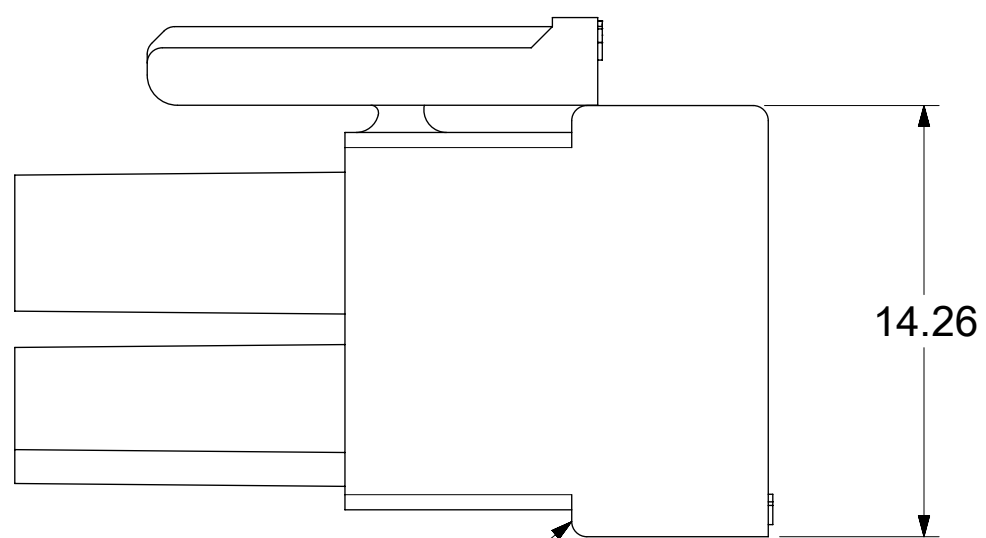
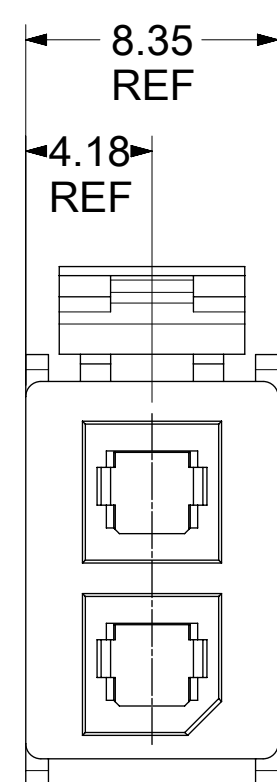
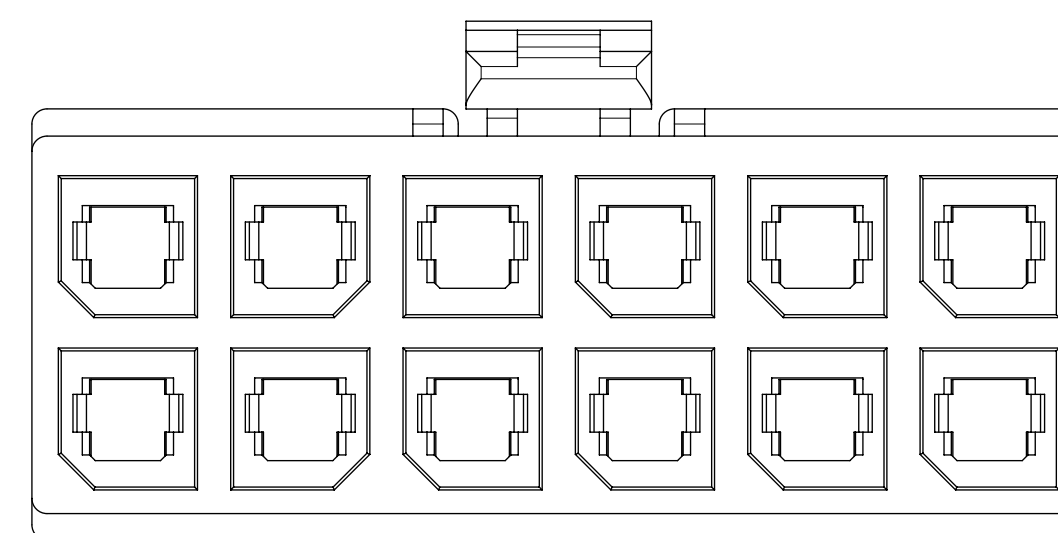

170001-0102

THIS DRAWING CONTAINS INFORMATION THAT IS PROPRIETARY TO MOLEX ELECTRONIC TECHNOLOGIES, LLC AND SHOULD NOT BE USED WITHOUT WRITTEN PERMISSION											
DIMENSION UNITS		SCALE		CURRENT REV DESC:							
mm		NTS									
GENERAL TOLERANCES (UNLESS SPECIFIED)				EC NO: 755658						DOCUMENT NUMBER	
ANGULAR TOL ± 0.5°				DRWN: WYATTH5 2023/06/21						DOC TYPE	
4 PLACES ±				CHK'D: XQZHANG 2023/07/24						DOC PART	
3 PLACES ±				APPR: XQZHANG 2023/07/24						REVISION	
2 PLACES ± 0.25				INITIAL REVISION:						SD-170001-0100	
1 PLACE ±				DRWN: MKARADIMAS 2010/11/23						PSD	
0 PLACES ±				APPR: APATEL 2012/06/13						001	
DRAFT WHERE APPLICABLE MUST REMAIN WITHIN DIMENSIONS				THIRD ANGLE PROJECTION		DRAWING		SERIES		CUSTOMER	
						D-SIZE		170001		GENERAL MARKET	
						SEE TABLE		GENERAL MARKET		SHEET NUMBER	
										2 OF 2	