

171692-0110

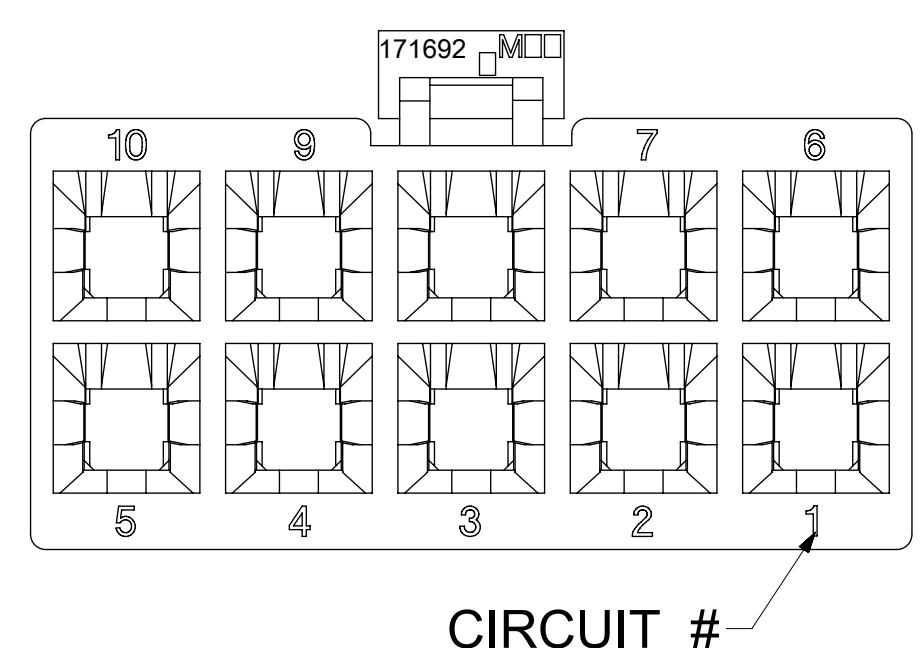
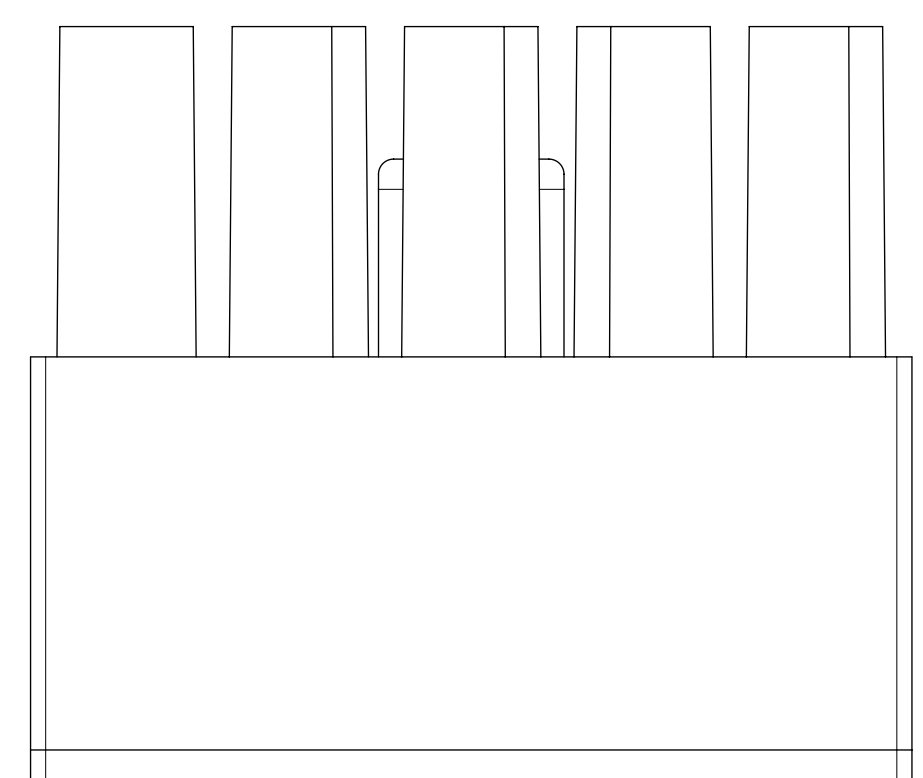
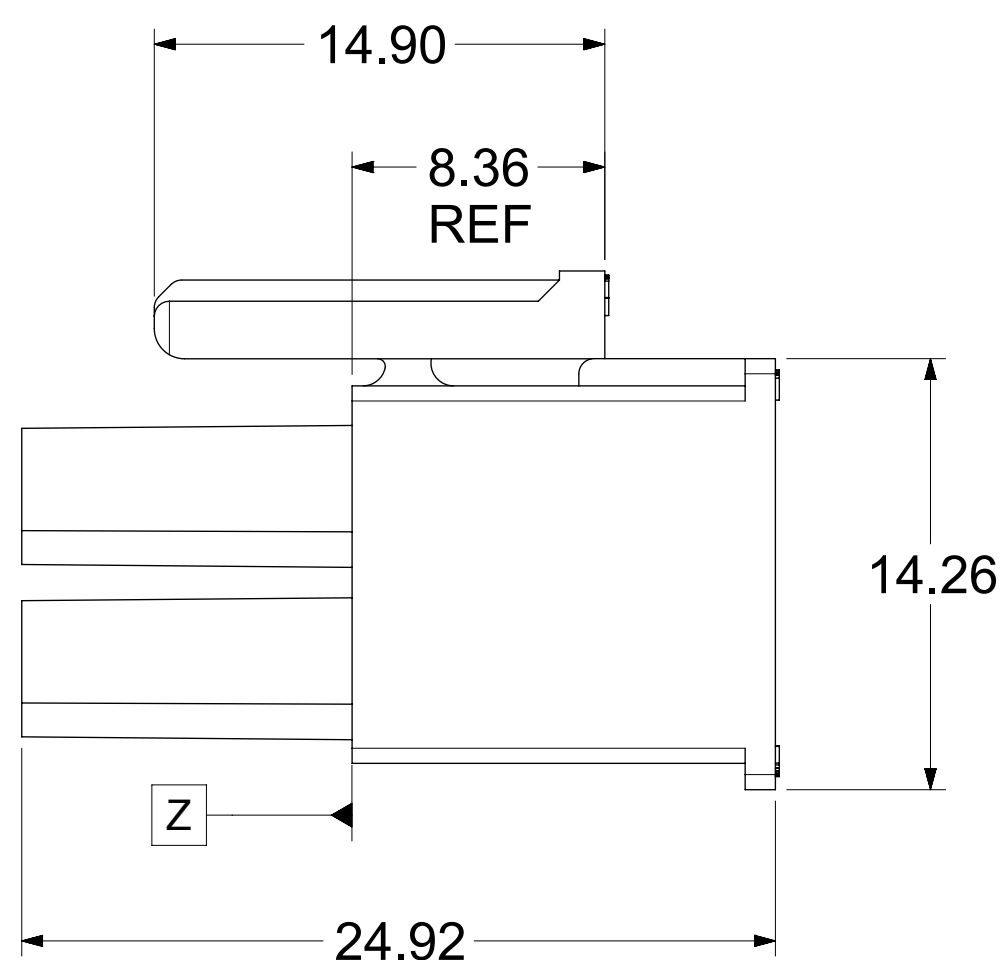
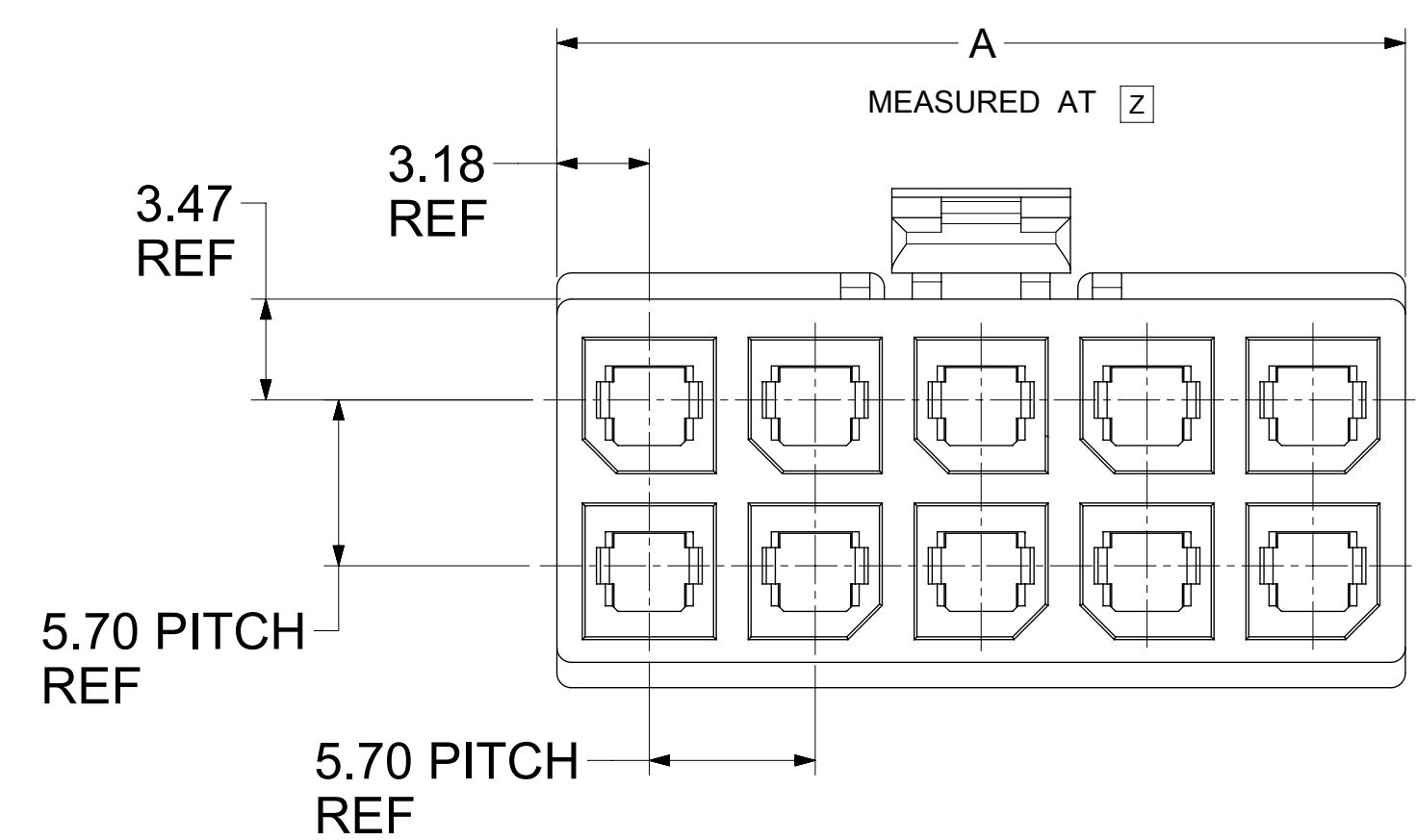

CIRCUIT #

CKT NO	PART NO	DIM A
2	171692-0102	8.35
4	171692-0104	12.05
6	171692-0106	17.75
8	171692-0108	23.45±0.40
10	171692-0110	29.15±0.40
12	171692-0112	34.85±0.40

NOTES:

- MATERIAL:
HOUSING: PBT, UL 94V-0, COLOR: BLACK.
- FINISH: NOT APPLICABLE.
- PRODUCT SPECIFICATION: PS-76823-100.
- PACKAGING: BULK PACK PER PK-170001-001
- PART MATES WITH MOLEX SERIES NUMBERS 76825, 76829, 172064, AND 172065.
- PART IS FOR USE WITH MOLEX FEMALE TERMINAL 76823-032X OR 172063-031X OR 172063-131X SERIES.
- APPLICATION SPECIFICATION: AS-76823-100.

THIS DRAWING CONTAINS INFORMATION THAT IS PROPRIETARY TO MOLEX ELECTRONIC TECHNOLOGIES, LLC AND SHOULD NOT BE USED WITHOUT WRITTEN PERMISSION		CURRENT REV DESC:			
DIMENSION UNITS	SCALE	EC NO: 755658			
mm	NTS	DRWN: WYATTH5 2023/07/04		MEGA-FIT RECEPTACLE HOUSING 2-12 CKT	
GENERAL TOLERANCES (UNLESS SPECIFIED)		CHK'D: XQZHANG 2023/07/24			
ANGULAR TOL ± 0.5°		APPR: XQZHANG 2023/07/24		PRODUCT CUSTOMER DRAWING	
4 PLACES ±	INITIAL REVISION:		DOCUMENT NUMBER		DOC TYPE
3 PLACES ±	DRWN: MKARADIMAS 2012/08/01		SD-171692-0100		PSD
2 PLACES ± 0.25	APPR: APATEL 2012/08/17		001		REVISION
1 PLACE ±	DRAFT WHERE APPLICABLE MUST REMAIN WITHIN DIMENSIONS		C2		
0 PLACES ±	THIRD ANGLE PROJECTION	DRAWING	SERIES	MATERIAL NUMBER	CUSTOMER
		D-SIZE	171692	SEE CHART	GENERAL MARKET
					SHEET NUMBER
					1 OF 2

2 CKTS

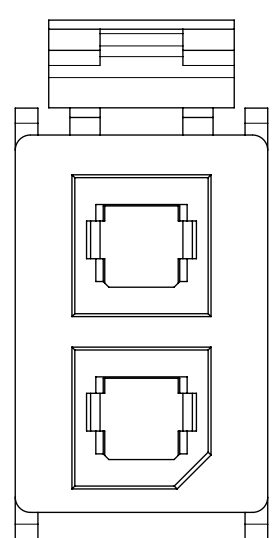

4 CKT

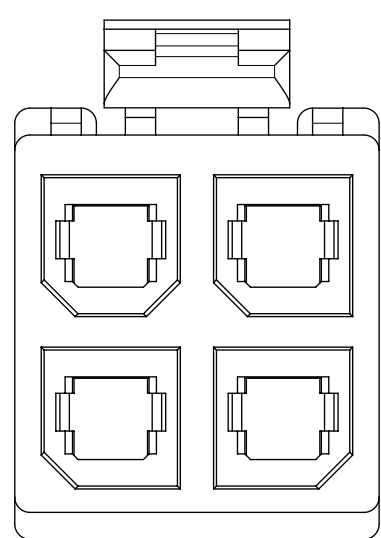

6 CKT

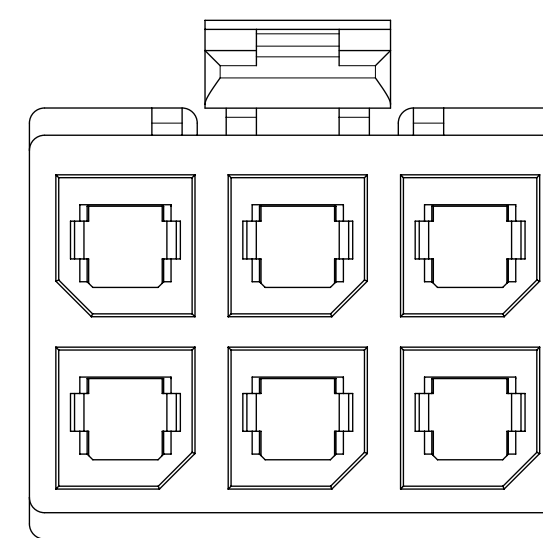

8 CKT

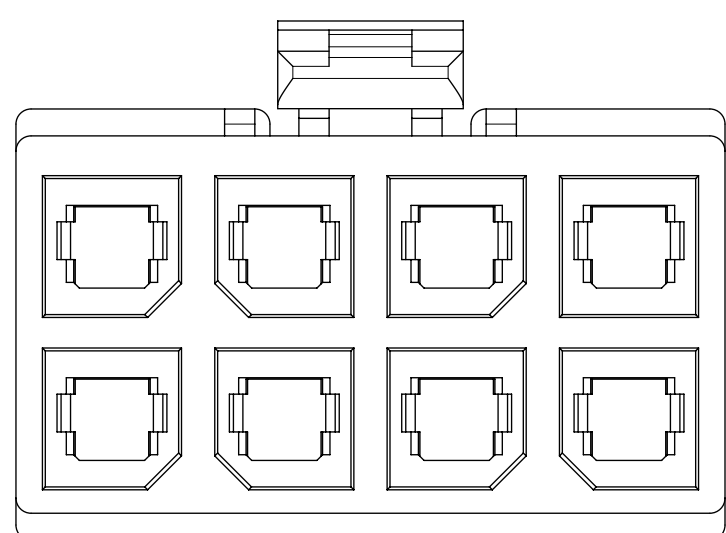

10 CKTS

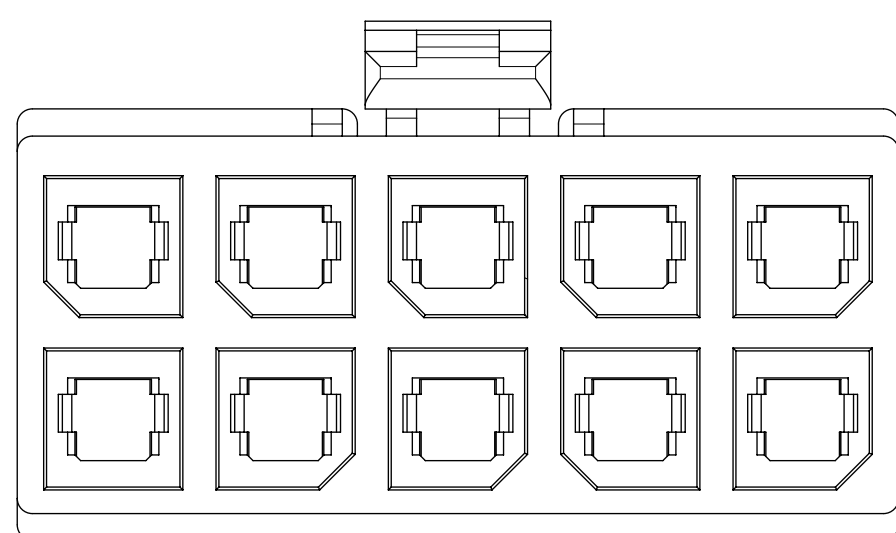

12 CKTS

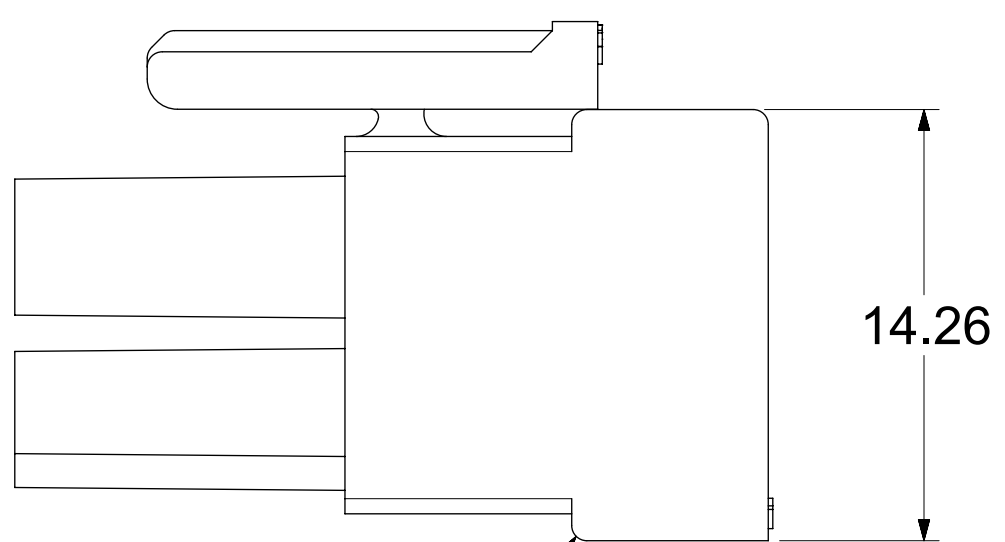
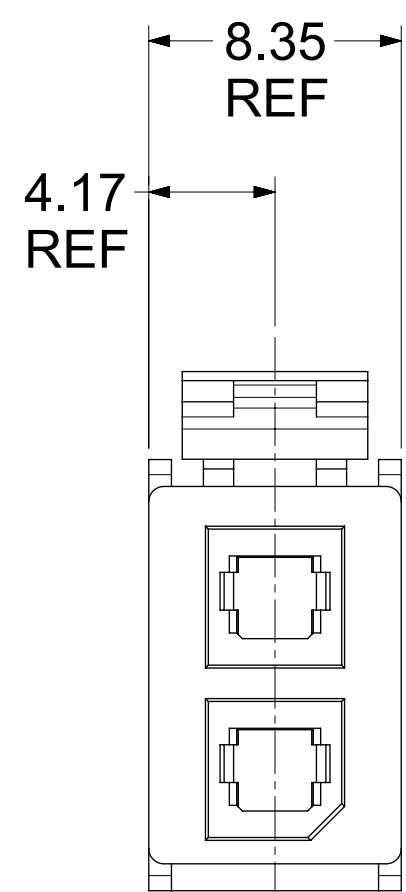
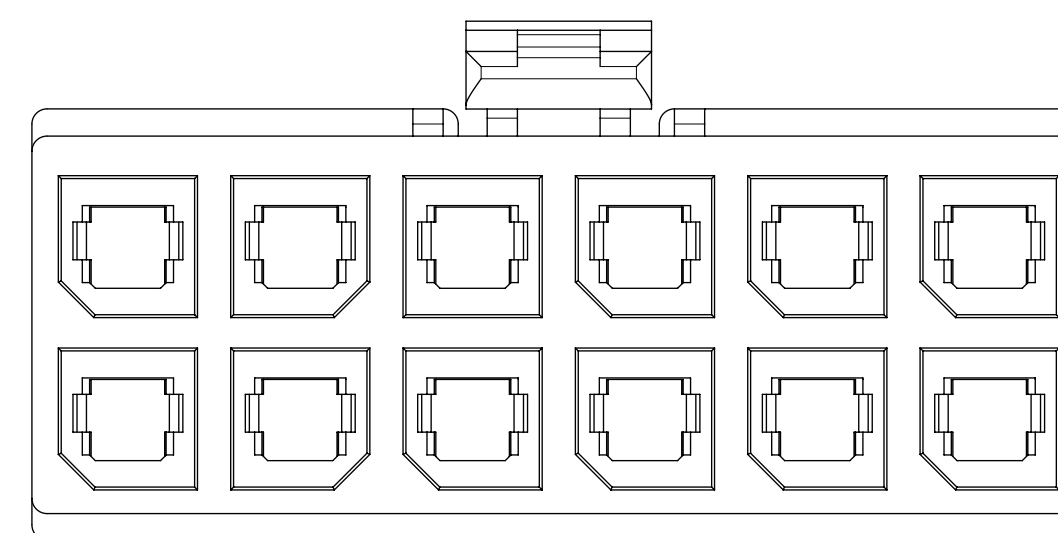

BOTTOM RIB ON
2 CKT ONLY

171692-0102

THIS DRAWING CONTAINS INFORMATION THAT IS PROPRIETARY TO MOLEX ELECTRONIC TECHNOLOGIES, LLC AND SHOULD NOT BE USED WITHOUT WRITTEN PERMISSION											
DIMENSION UNITS		SCALE		CURRENT REV DESC:						molex	
mm		NTS									
GENERAL TOLERANCES (UNLESS SPECIFIED)				EC NO: 755658							
ANGULAR TOL ± 0.5°				4 PLACES ±		DRWN: WYATTH5		2023/07/04		MEGA-FIT RECEPTACLE HOUSING 2-12 CKT	
				3 PLACES ±		CHK'D: XQZHANG		2023/07/24			
				2 PLACES ± 0.25		APPR: XQZHANG		2023/07/24		PRODUCT CUSTOMER DRAWING	
				1 PLACE ±		INITIAL REVISION:				DOCUMENT NUMBER	
				0 PLACES ±		DRWN: MKARADIMAS		2012/08/01		DOC TYPE	
DRAFT WHERE APPLICABLE MUST REMAIN WITHIN DIMENSIONS				THIRD ANGLE PROJECTION		DRAWING		SERIES		DOC PART	
				D-SIZE		171692		MATERIAL NUMBER		REVISION	
				SEE CHART		GENERAL MARKET		CUSTOMER		SHEET NUMBER	
				2 OF 2							