

| CKT NO | PART NO     | DIM A      |
|--------|-------------|------------|
| 2      | 170001-0102 | 8.35       |
| 4      | 170001-0104 | 12.05      |
| 6      | 170001-0106 | 17.75      |
| 8      | 170001-0108 | 23.45±0.40 |
| 10     | 170001-0110 | 29.15±0.40 |
| 12     | 170001-0112 | 34.85±0.40 |

170001-0110

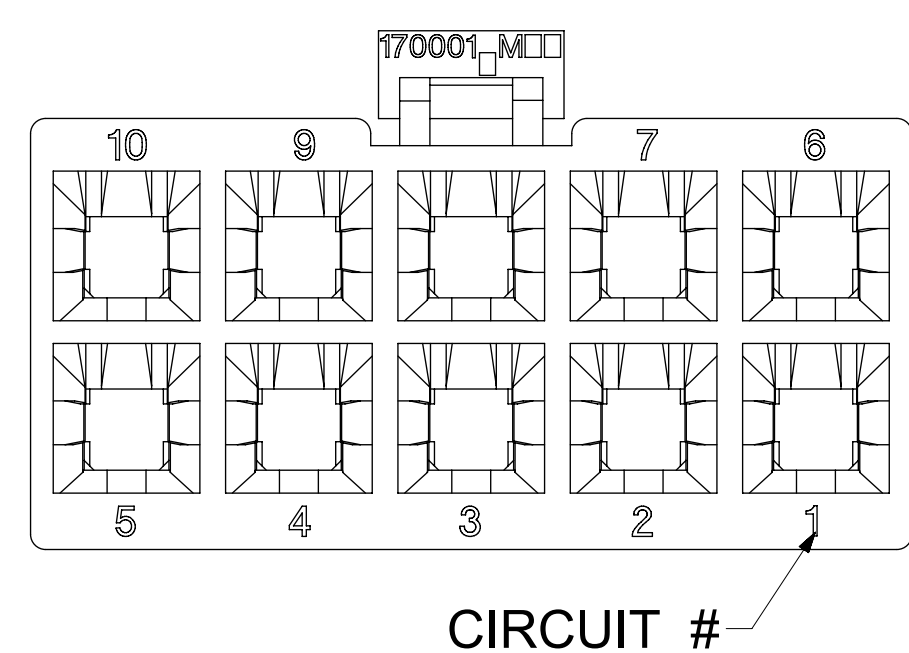
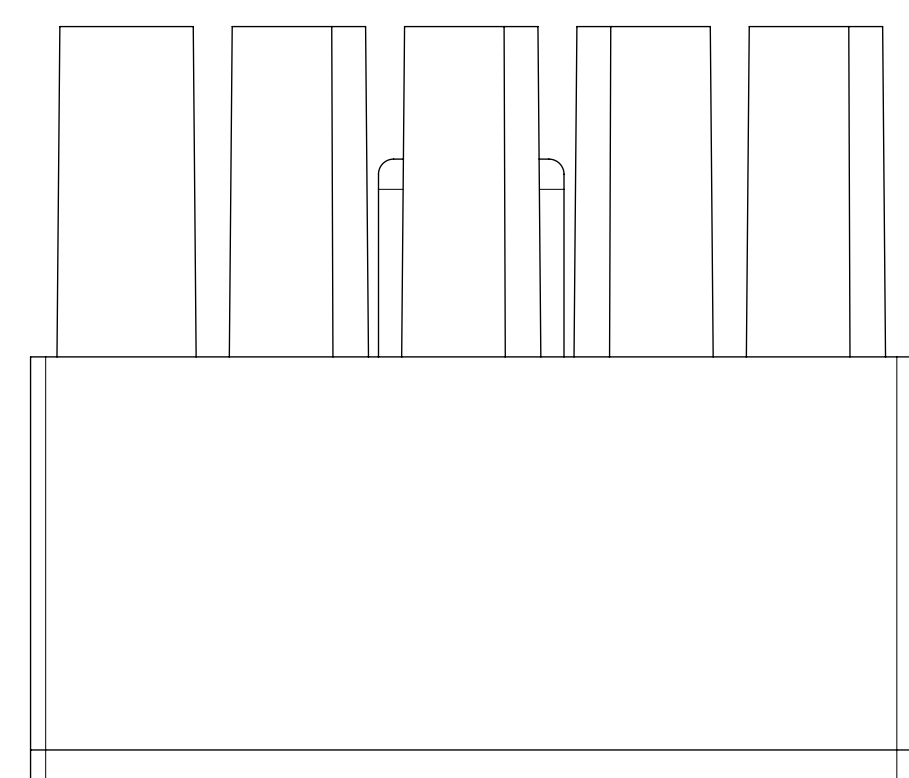
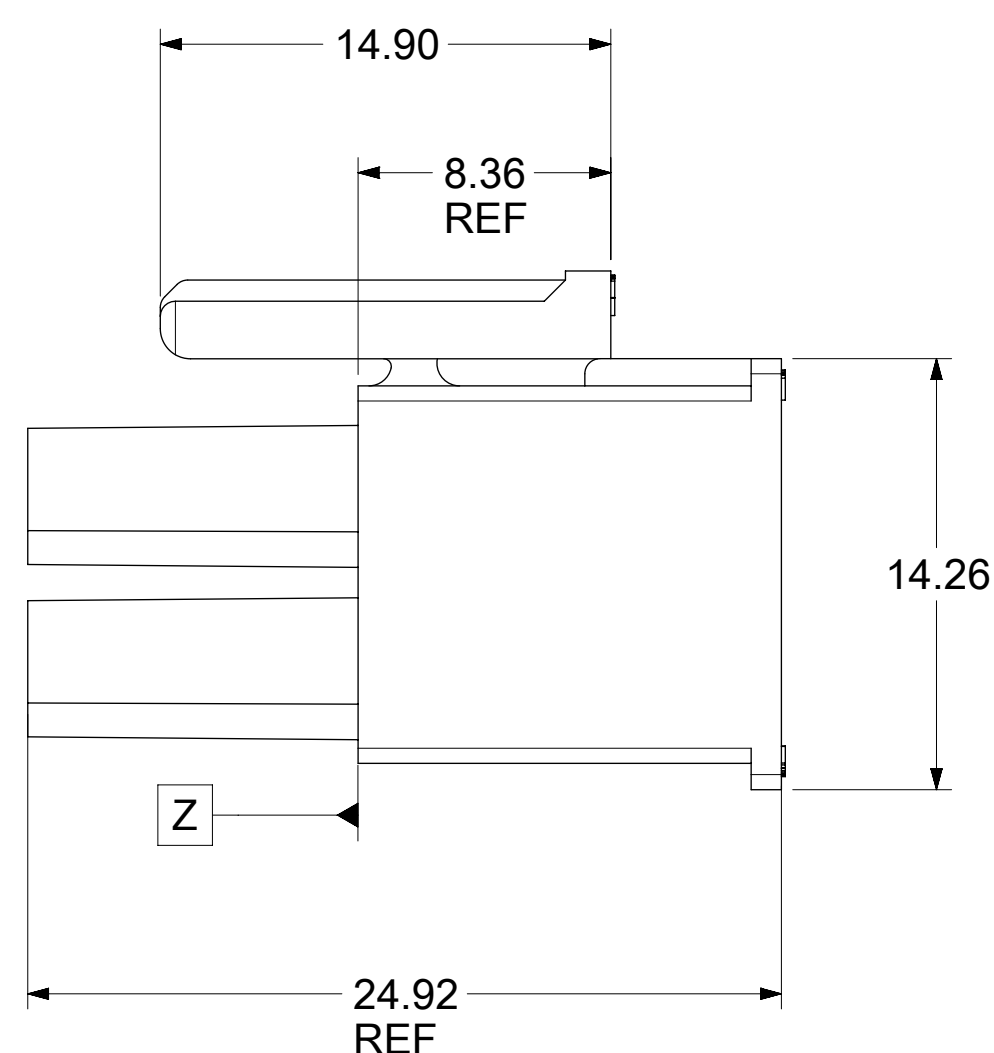
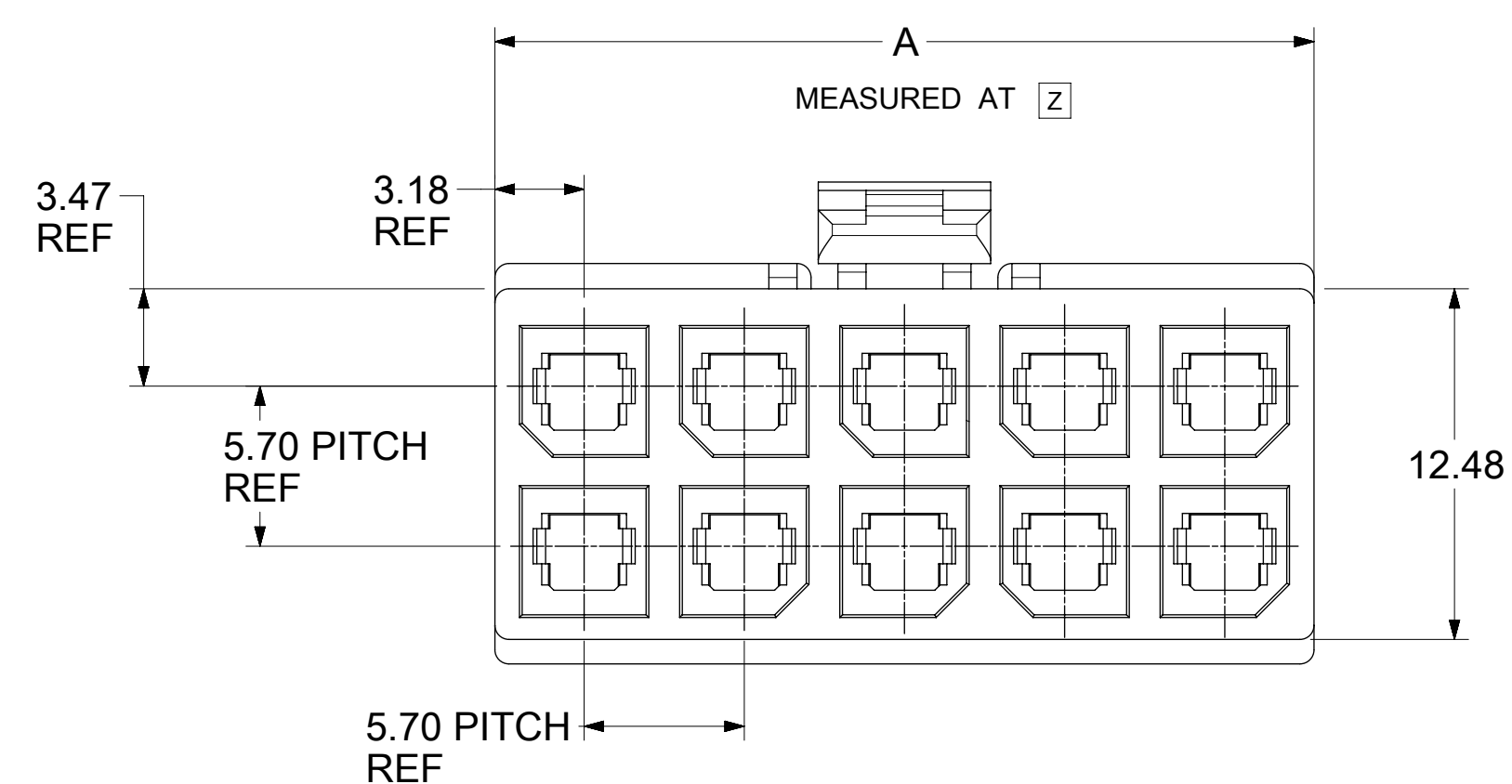

NOTES:

- MATERIAL:  
HOUSING: NYLON, UL 94V-2, GLOW WIRE CAPABLE PER IEC-60335-1 5TH EDITION, COLOR: BLACK.
- FINISH: NOT APPLICABLE.
- PRODUCT SPECIFICATION: PS-76823-100.
- PACKAGING: BULK PACK PER PK-170001-001
- PART MATES WITH MOLEX SERIES NUMBERS 76825, 76829, 172064, AND 172065.
- PART IS FOR USE WITH MOLEX FEMALE TERMINAL 76823-032X OR 172063-031X OR 172063-131X SERIES.
- APPLICATION SPECIFICATION: AS-76823-100.

|   |  |       |  |                             |  |         |  |                |  |                 |  |
|---|--|-------|--|-----------------------------|--|---------|--|----------------|--|-----------------|--|
| THIS DRAWING CONTAINS INFORMATION THAT IS PROPRIETARY TO MOLEX ELECTRONIC TECHNOLOGIES, LLC AND SHOULD NOT BE USED WITHOUT WRITTEN PERMISSION |  |       |  |                             |  |         |  |                |  |                 |  |
| DIMENSION UNITS   |  | SCALE |  | CURRENT REV DESC:           |  |         |  |                |  |                 |  |
| mm  |  | NTS   |  |                             |  |         |  |                |  |                 |  |
| GENERAL TOLERANCES (UNLESS SPECIFIED)   |  |       |  | EC NO: 755658               |  |         |  |                |  |                 |  |
| ANGULAR TOL ± 0.5°  |  |       |  | DRWN: WYATTH5 2023/06/21    |  |         |  |                |  |                 |  |
| 4 PLACES ±  |  |       |  | CHK'D: XQZHANG 2023/07/24   |  |         |  |                |  |                 |  |
| 3 PLACES ±  |  |       |  | APPR: XQZHANG 2023/07/24    |  |         |  |                |  |                 |  |
| 2 PLACES ± 0.25   |  |       |  | INITIAL REVISION:           |  |         |  |                |  |                 |  |
| 1 PLACE ±   |  |       |  | DRWN: MKARADIMAS 2010/11/23 |  |         |  |                |  |                 |  |
| 0 PLACES ±  |  |       |  | APPR: APATEL 2012/06/13     |  |         |  |                |  |                 |  |
| DRAFT WHERE APPLICABLE MUST REMAIN WITHIN DIMENSIONS  |  |       |  | THIRD ANGLE PROJECTION      |  | DRAWING |  | SERIES         |  | MATERIAL NUMBER |  |
|   |  |       |  |                             |  | D-SIZE  |  | 170001         |  | SEE TABLE       |  |
|   |  |       |  |                             |  |         |  | CUSTOMER       |  | SHEET NUMBER    |  |
|   |  |       |  |                             |  |         |  | GENERAL MARKET |  | 1 OF 2          |  |

|  |          |          |          |
|--|----------|----------|----------|
| MEGA-FIT RECEPTACLE HOUSING 2-12 CKT GLOW WIRE |          |          |          |
| PRODUCT CUSTOMER DRAWING                       |          |          |          |
| DOCUMENT NUMBER                                | DOC TYPE | DOC PART | REVISION |
| SD-170001-0100                                 | PSD      | 001      | C        |

2 CKTS

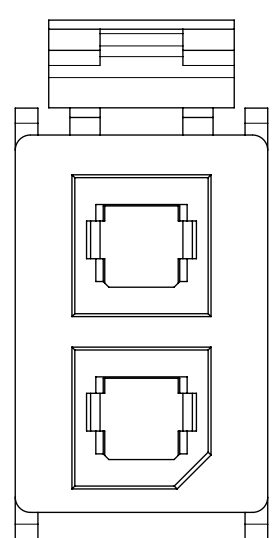

4 CKT

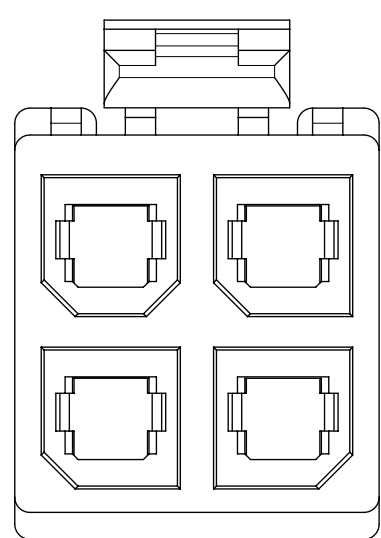

6 CKT

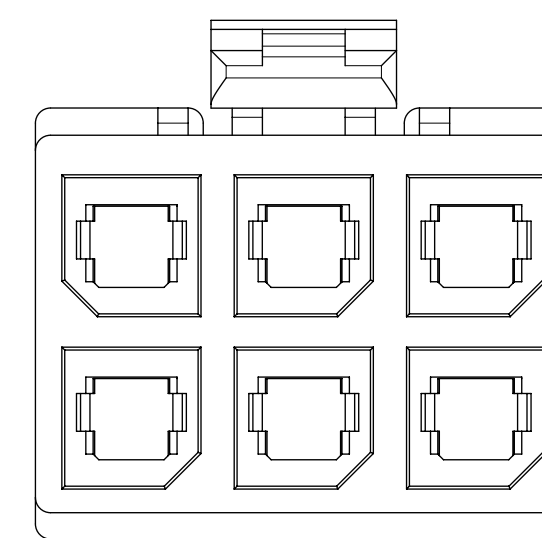

8 CKT

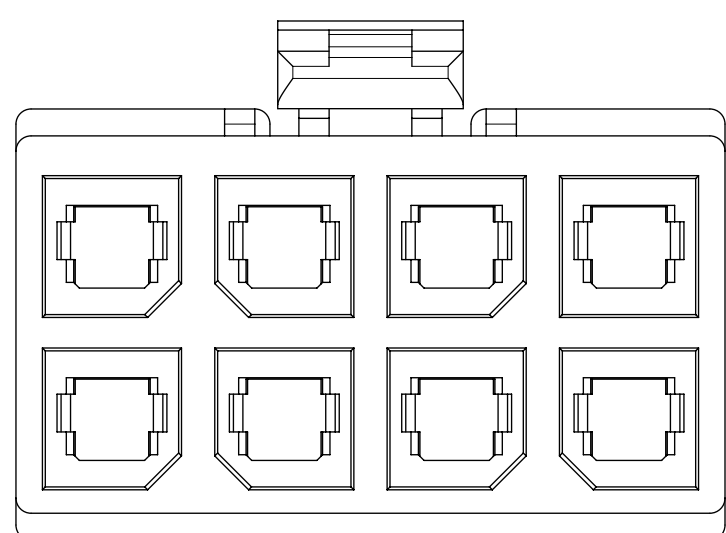

10 CKTS

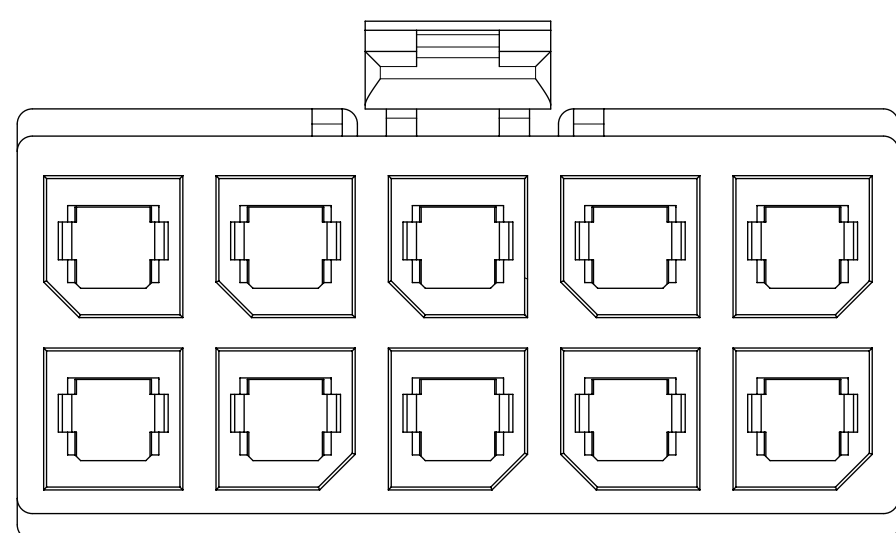

12 CKTS

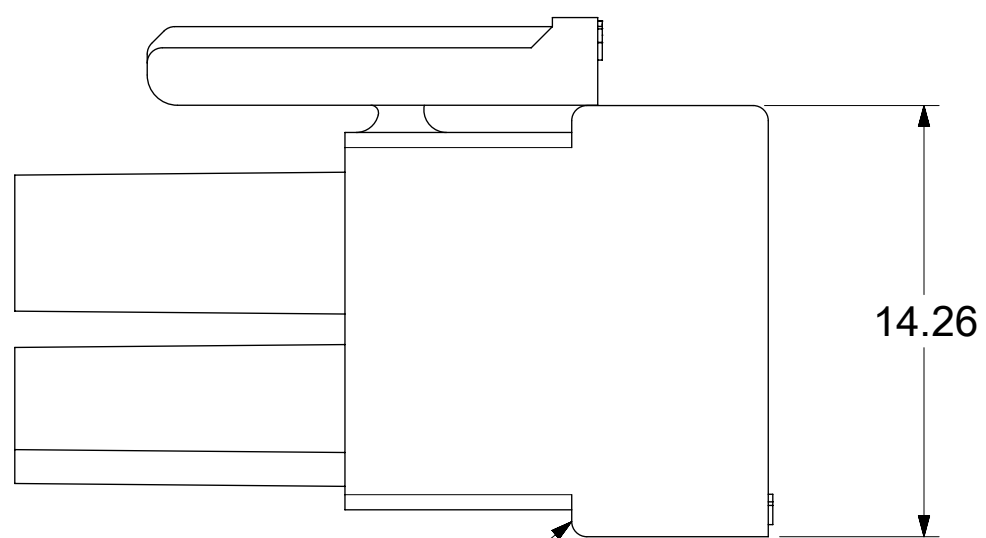
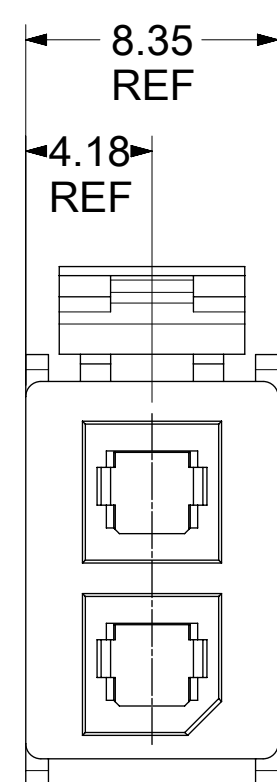
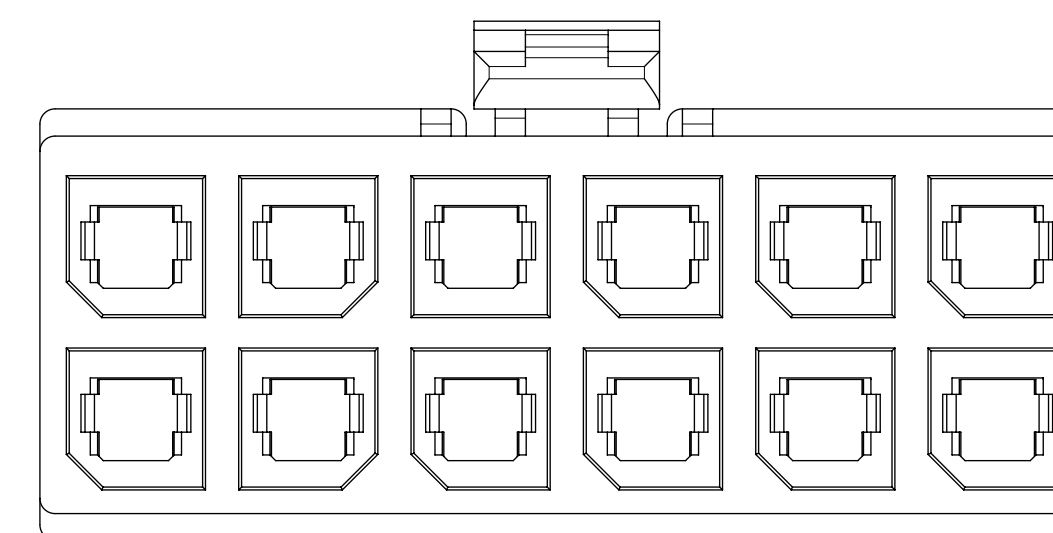

BOTTOM RIBS ON 2CKT ONLY

170001-0102

|   |  |       |  |                             |  |           |  |                |  |  |  |
|---|--|-------|--|-----------------------------|--|-----------|--|----------------|--|--|--|
| THIS DRAWING CONTAINS INFORMATION THAT IS PROPRIETARY TO MOLEX ELECTRONIC TECHNOLOGIES, LLC AND SHOULD NOT BE USED WITHOUT WRITTEN PERMISSION |  |       |  |                             |  |           |  |                |  |  |  |
| DIMENSION UNITS   |  | SCALE |  | CURRENT REV DESC:           |  |           |  |                |  | <b>molex</b>                                   |  |
| mm  |  | NTS   |  |                             |  |           |  |                |  |  |  |
| GENERAL TOLERANCES (UNLESS SPECIFIED)   |  |       |  | EC NO: 755658               |  |           |  |                |  | MEGA-FIT RECEPTACLE HOUSING 2-12 CKT GLOW WIRE |  |
| ANGULAR TOL ± 0.5°  |  |       |  | DRWN: WYATTH5 2023/06/21    |  |           |  |                |  | PRODUCT CUSTOMER DRAWING                       |  |
| 4 PLACES ±  |  |       |  | CHK'D: XQZHANG 2023/07/24   |  |           |  |                |  | DOCUMENT NUMBER                                |  |
| 3 PLACES ±  |  |       |  | APPR: XQZHANG 2023/07/24    |  |           |  |                |  | DOC TYPE                                       |  |
| 2 PLACES ± 0.25   |  |       |  | INITIAL REVISION:           |  |           |  |                |  | DOC PART                                       |  |
| 1 PLACE ±   |  |       |  | DRWN: MKARADIMAS 2010/11/23 |  |           |  |                |  | REVISION                                       |  |
| 0 PLACES ±  |  |       |  | APPR: APATEL 2012/06/13     |  |           |  |                |  | SD-170001-0100                                 |  |
| DRAFT WHERE APPLICABLE MUST REMAIN WITHIN DIMENSIONS  |  |       |  | THIRD ANGLE PROJECTION      |  | DRAWING   |  | SERIES         |  | MATERIAL NUMBER                                |  |
|   |  |       |  |                             |  | D-SIZE    |  | 170001         |  | CUSTOMER                                       |  |
|   |  |       |  |                             |  | SEE TABLE |  | GENERAL MARKET |  | SHEET NUMBER                                   |  |
|   |  |       |  |                             |  |           |  |                |  | 2 OF 2   |  |