

PLUG P/N	CKT	DIM "A"	DIM "B"
1727621002	2	5.40	4.95
1727621004	4	9.60	4.95
1727621006	6	13.80	4.95
1727621008	8	18.00	4.95
1727621010	10	22.20	12.95
1727621012	12	26.40	12.95
1727621014	14	30.60	12.95
1727621016	16	34.80	12.95
1727621018	18	39.00	20.95

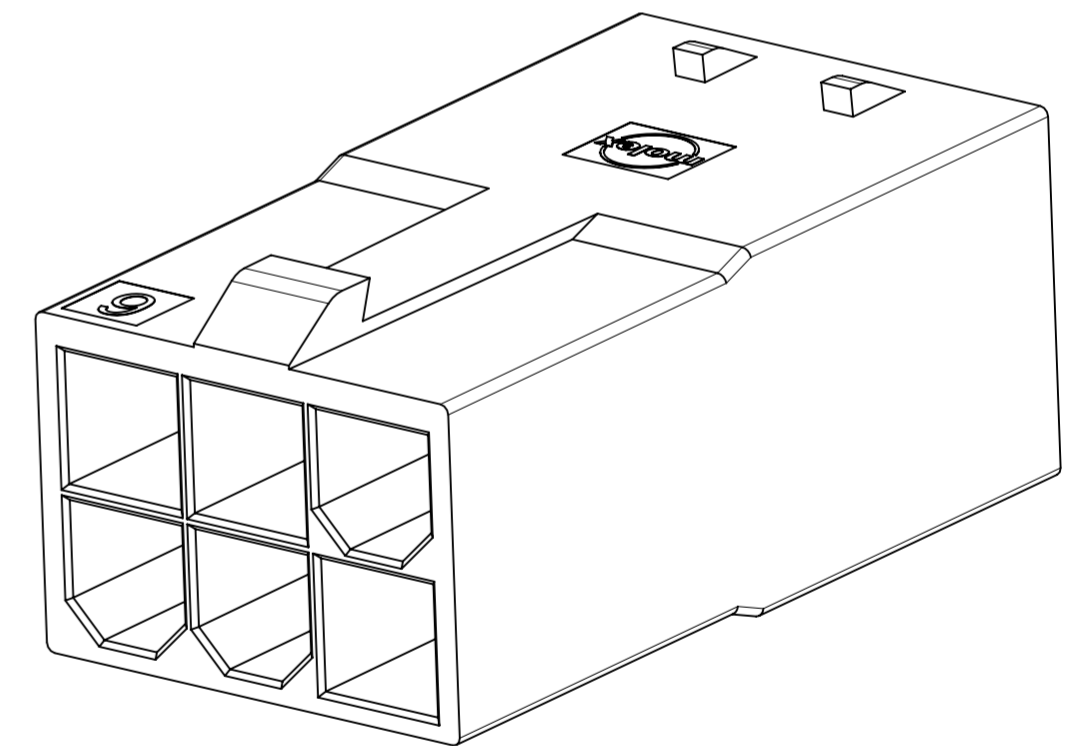
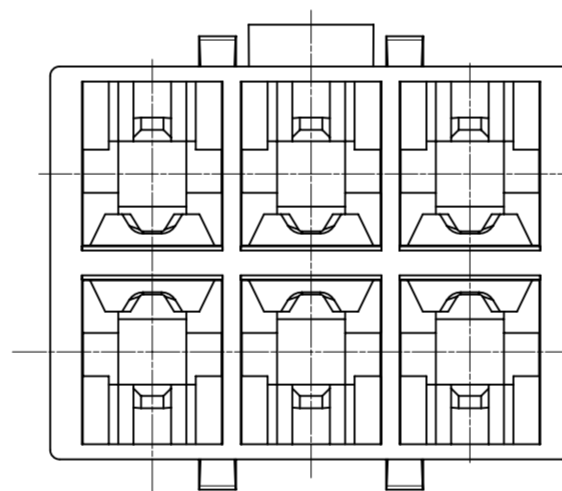
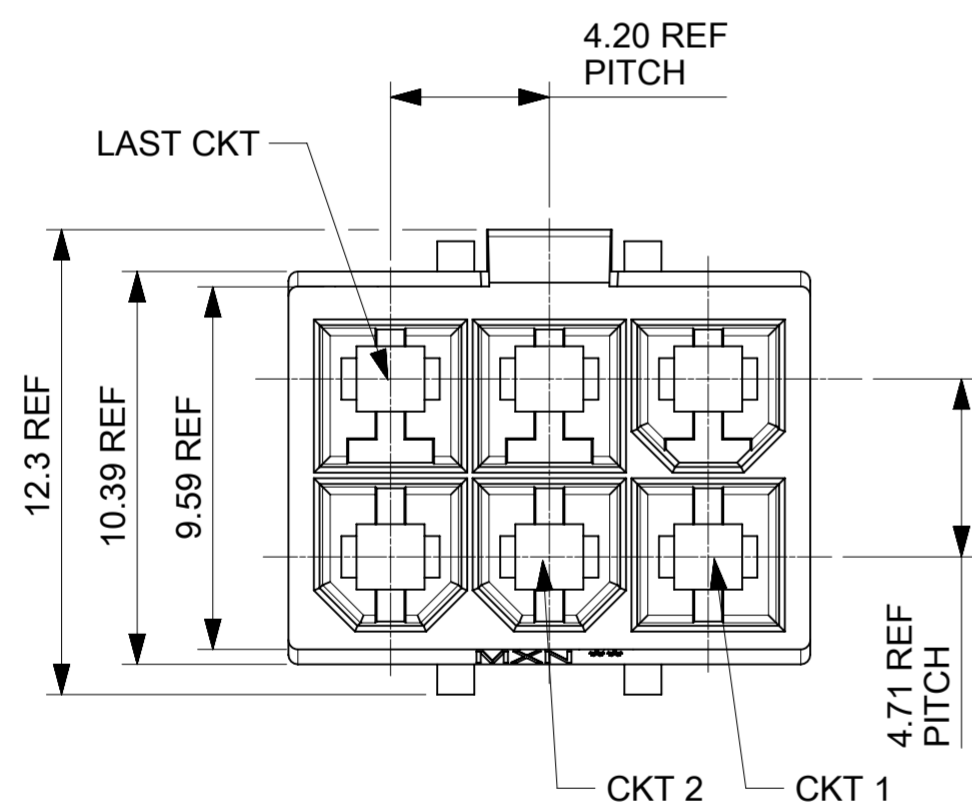

- NOTES:
- MATERIAL: NYLON, UL 94V-0 AND GLOW WIRE CAPABLE PER IEC60335-1; COLOR: BLACK
  - FINISH: NONE
  - PRODUCT SPECIFICATION: 2131370000-PS/2029880002-PS  
APPLICATION SPECIFICATION: 2131370000-AS
  - PACKAGING SPECIFICATION: 1727620001-PK  
REFER TO AS-45499-001 FOR MOISTURIZING NYLON CONNECTOR PARTS.
  - THIS PART TO BE USED WITH FEMALE TERMINAL SERIES 172765, 203070 AND TPA SERIES 172709-2\*\*\*.
  - THIS PART MATES WITH RECEPTACLE SERIES 172708-0\*\*\*, 172708-1\*\*\*.
  - THIS PART CONFORMS TO CLASS 'B' REQUIREMENTS OF COSMETIC SPECIFICATION PS-45499-002.

THIS DRAWING CONTAINS INFORMATION THAT IS PROPRIETARY TO MOLEX ELECTRONIC TECHNOLOGIES, LLC AND SHOULD NOT BE USED WITHOUT WRITTEN PERMISSION									
DIMENSION UNITS		SCALE		CURRENT REV DESC:				<b>molex</b>	
mm		NTS							
GENERAL TOLERANCES (UNLESS SPECIFIED)								SD-DRAWING OF MINI-FIT SIGMA DR PLUG	
ANGULAR TOL ± °				EC NO: 768511				PRODUCT CUSTOMER DRAWING	
4 PLACES ±				DRWN: JERRYW8		2023/11/02			
3 PLACES ±				CHK'D: XQZHANG		2023/11/15			
2 PLACES ± 0.25				APPR: XQZHANG		2023/11/15			
1 PLACE ± 0.36				INITIAL REVISION:				DOCUMENT NUMBER	
0 PLACES ±				DRWN: ALUO02		2019/09/18		1727620001-SD	
				APPR: YXZHENG		2019/10/11		DOC TYPE   DOC PART   REVISION	
DRAFT WHERE APPLICABLE MUST REMAIN WITHIN DIMENSIONS		THIRD ANGLE PROJECTION		DRAWING		SERIES		MATERIAL NUMBER   CUSTOMER	
				A2-SIZE		172762		SEE TABLE   GENERAL MARKET	
								SHEET NUMBER	
								1 OF 4	

DOCUMENT STATUS	P1	RELEASE DATE	2023/11/15	09:48:29
-----------------	----	--------------	------------	----------

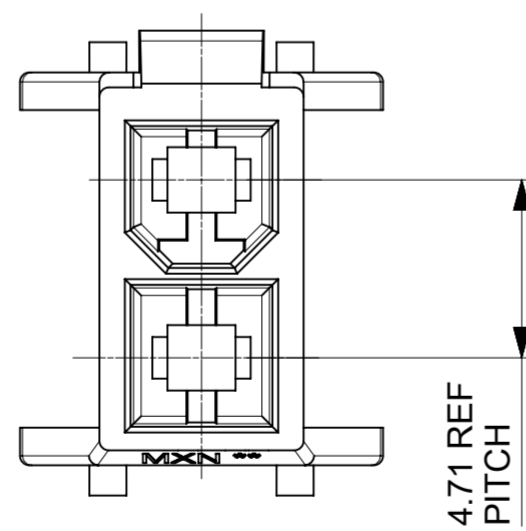
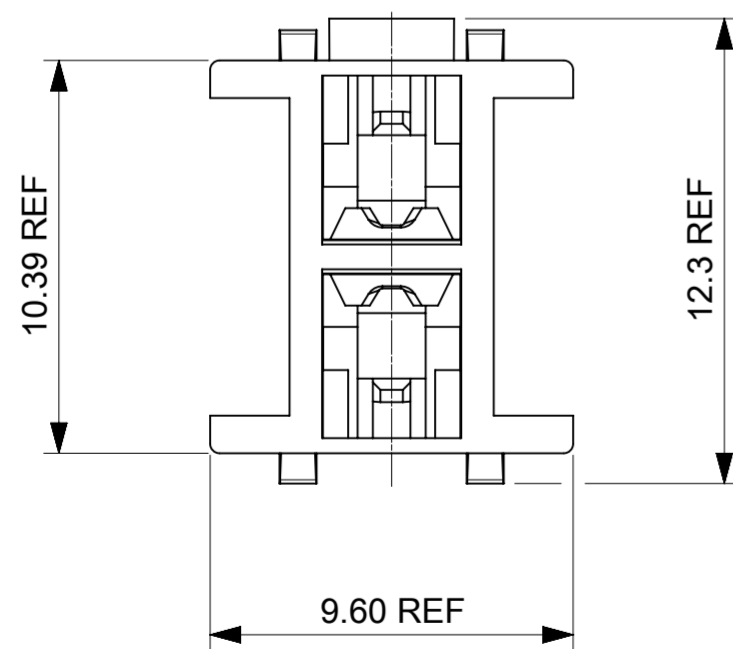
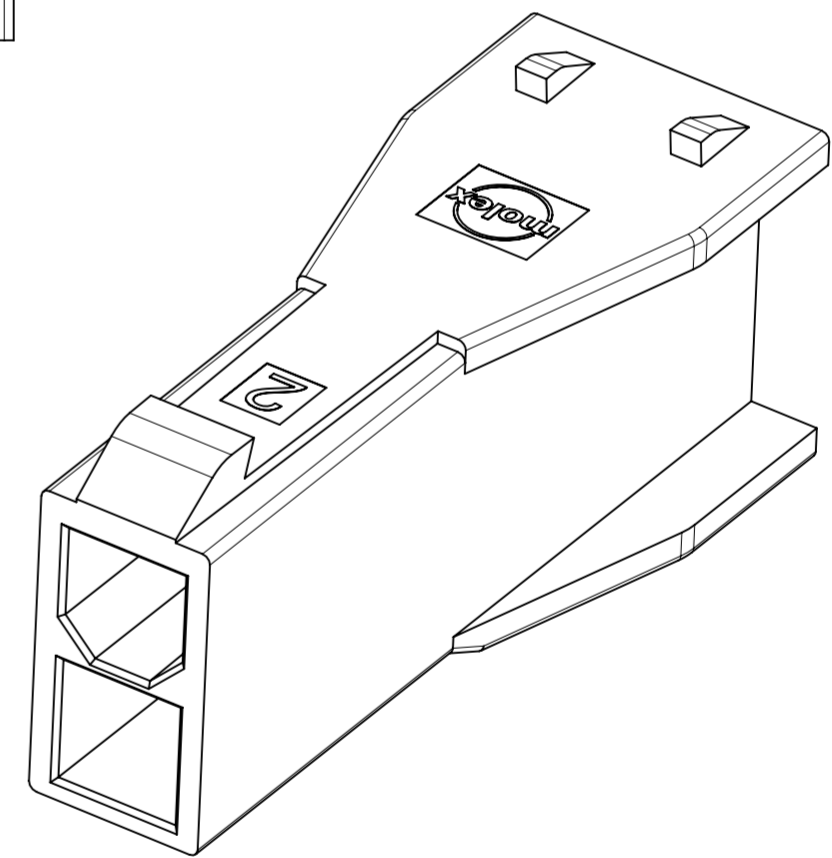
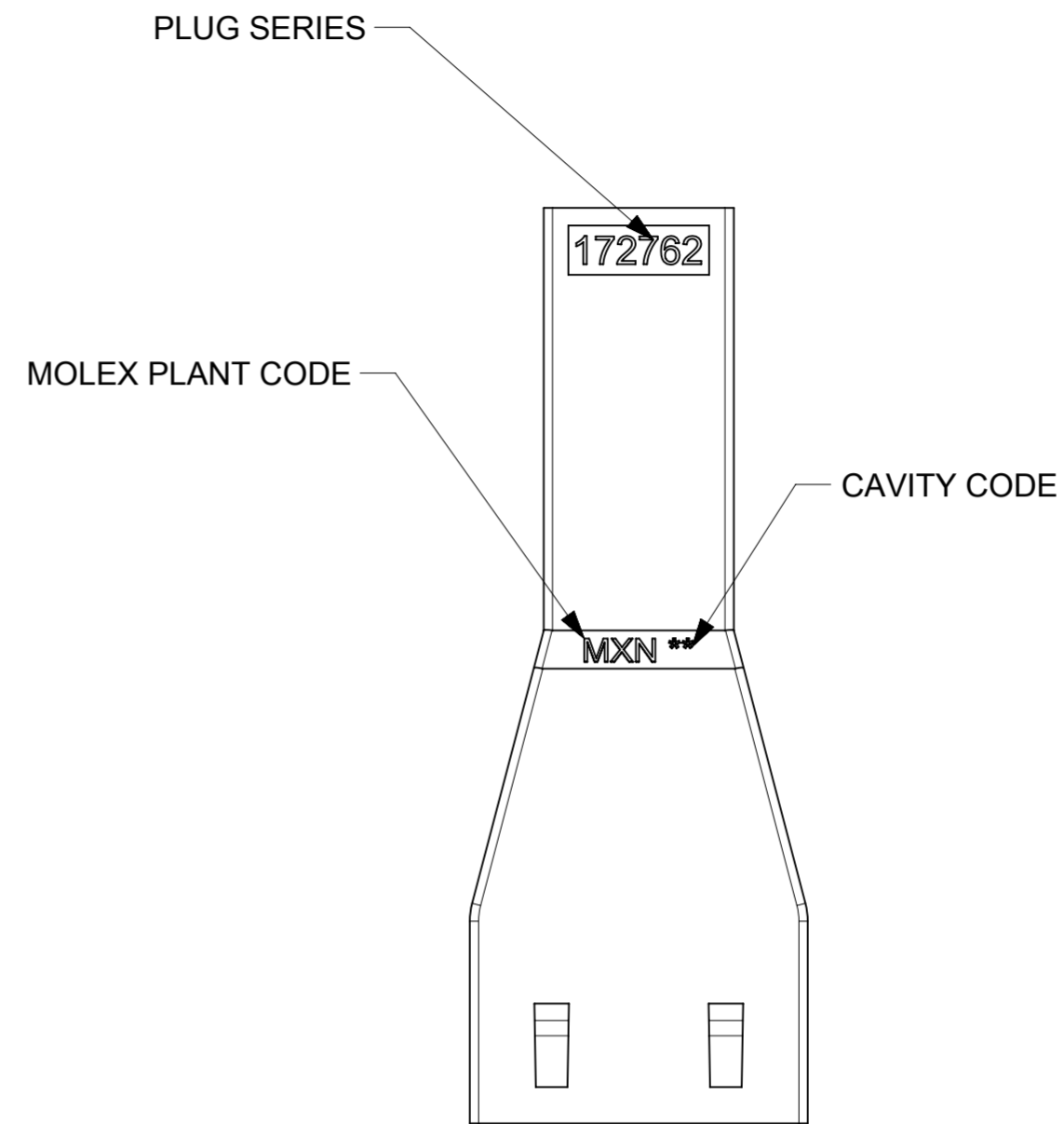
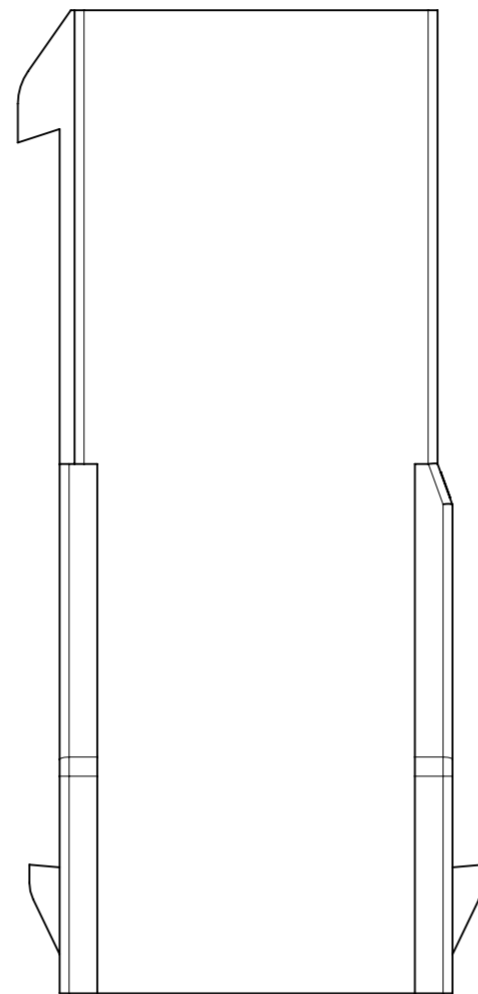
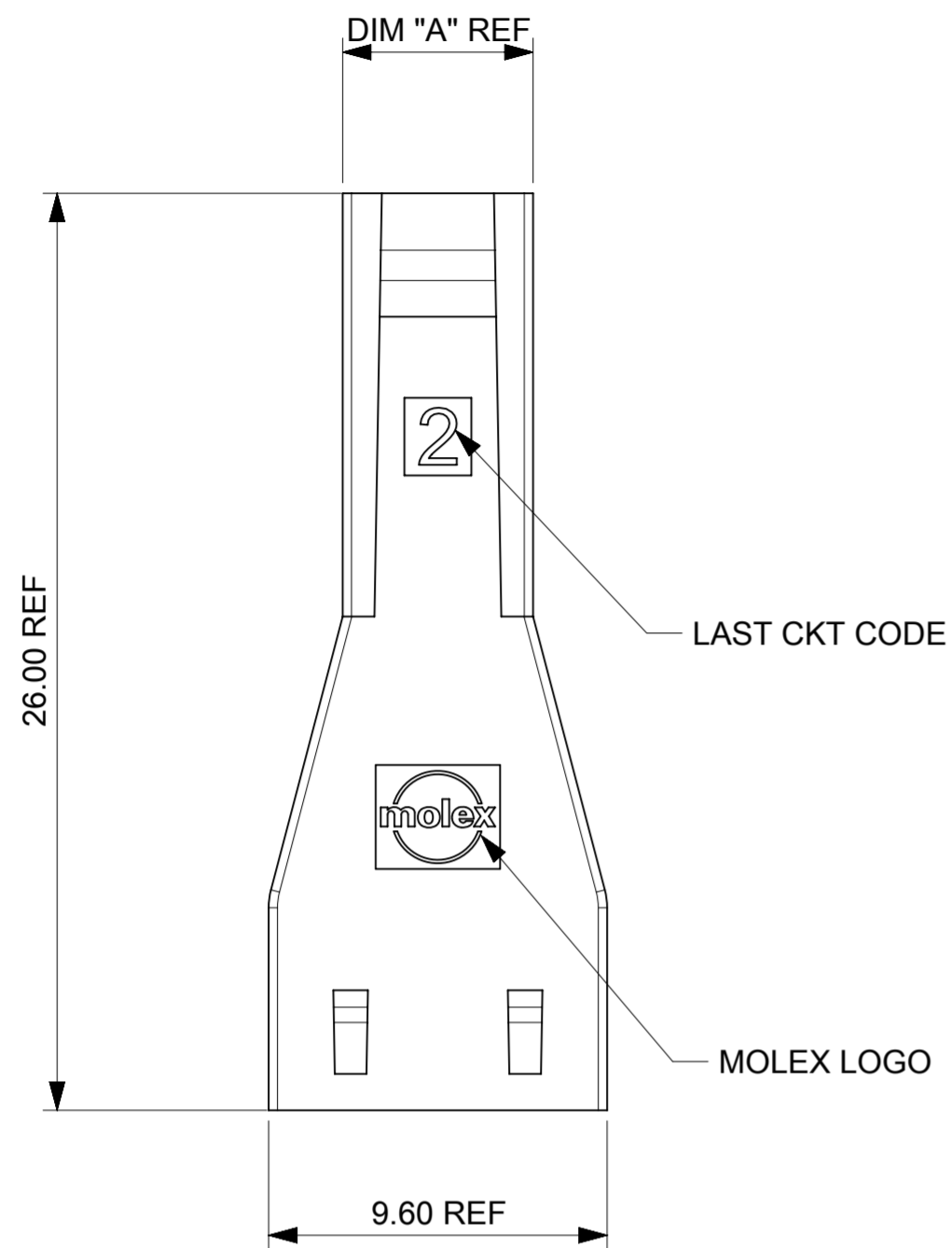

THIS DRAWING CONTAINS INFORMATION THAT IS PROPRIETARY TO MOLEX ELECTRONIC TECHNOLOGIES, LLC AND SHOULD NOT BE USED WITHOUT WRITTEN PERMISSION									
DIMENSION UNITS		SCALE		CURRENT REV DESC:				<b>molex</b>	
mm		NTS							
GENERAL TOLERANCES (UNLESS SPECIFIED)								SD-DRAWING OF MINI-FIT SIGMA DR PLUG	
ANGULAR TOL		± °		EC NO: 768511				PRODUCT CUSTOMER DRAWING	
4 PLACES		±		DRWN: JERRYW8		2023/11/02			
3 PLACES		±		CHK'D: XQZHANG		2023/11/15			
2 PLACES		± 0.25		APPR: XQZHANG		2023/11/15			
1 PLACE		± 0.36		INITIAL REVISION:				DOCUMENT NUMBER	
0 PLACES		±		DRWN: ALU002		2019/09/18		1727620001-SD	
				APPR: YXZHENG		2019/10/11		PSD 000 A6	
DRAFT WHERE APPLICABLE MUST REMAIN WITHIN DIMENSIONS		THIRD ANGLE PROJECTION		DRAWING		SERIES		MATERIAL NUMBER	
				A2-SIZE		172762		SEE TABLE	
				GENERAL MARKET				SHEET NUMBER	
								2 OF 4	

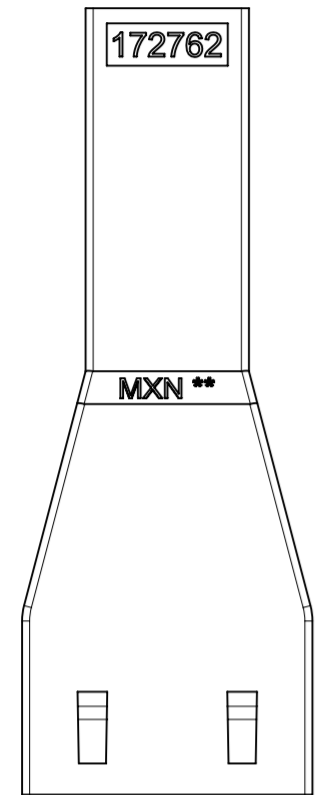
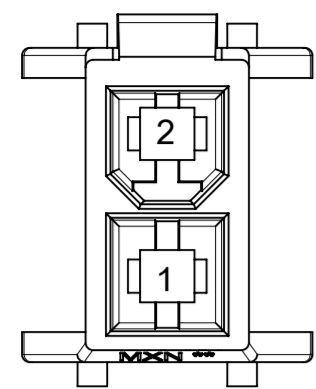

2-CKT

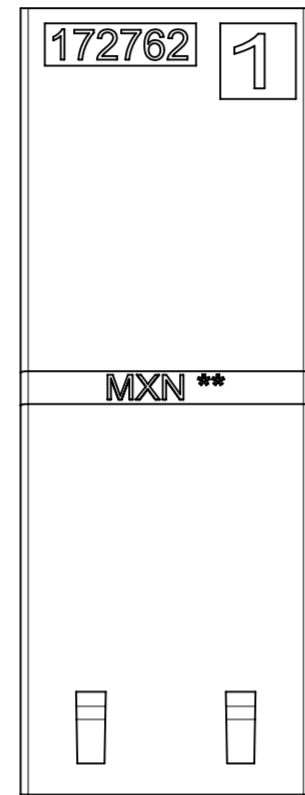
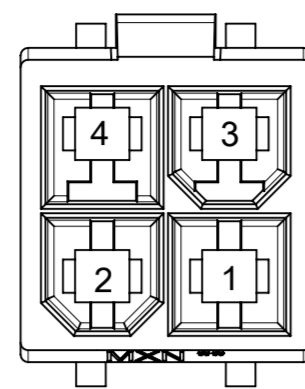

4-CKT

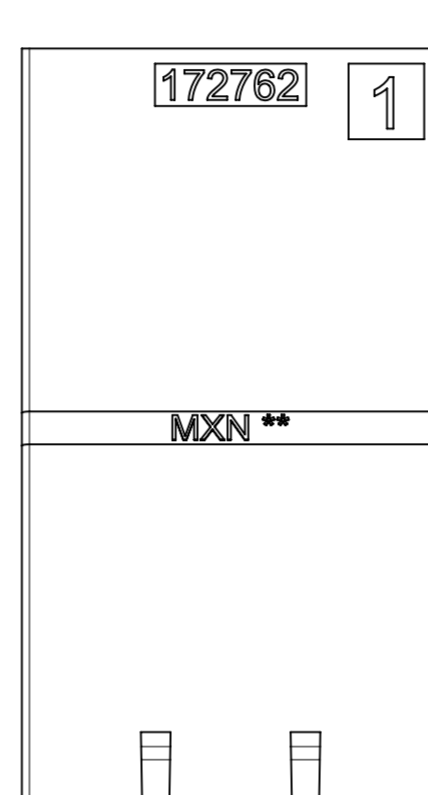
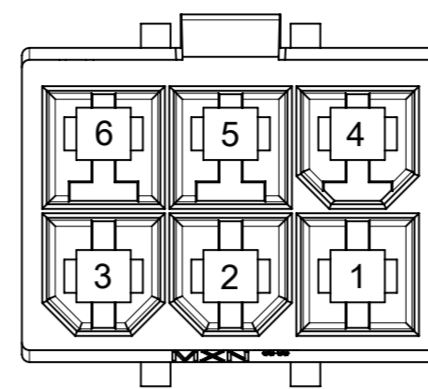

6-CKT

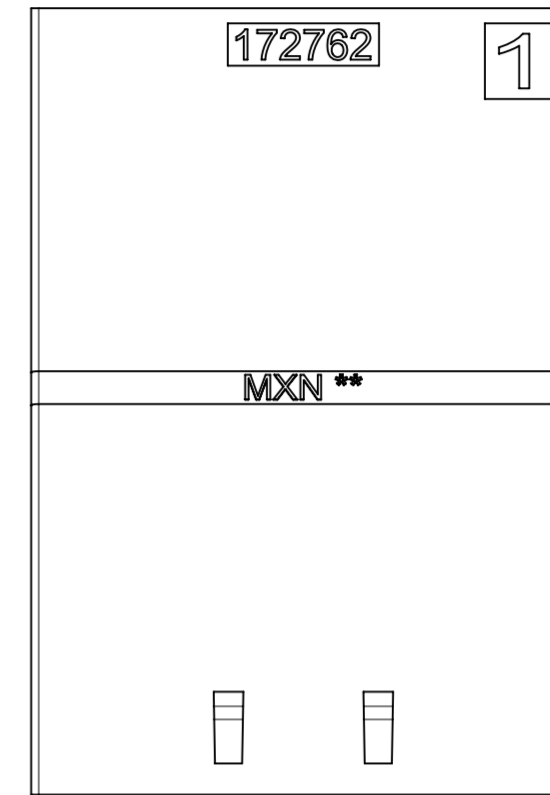
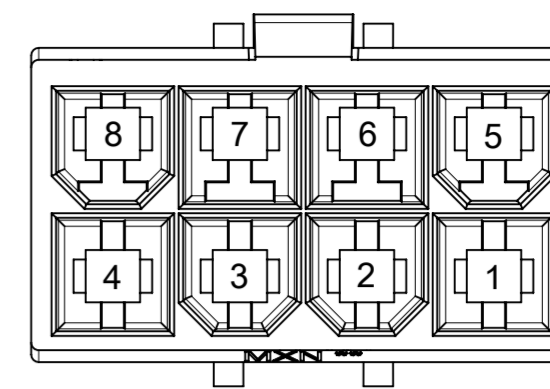

8-CKT

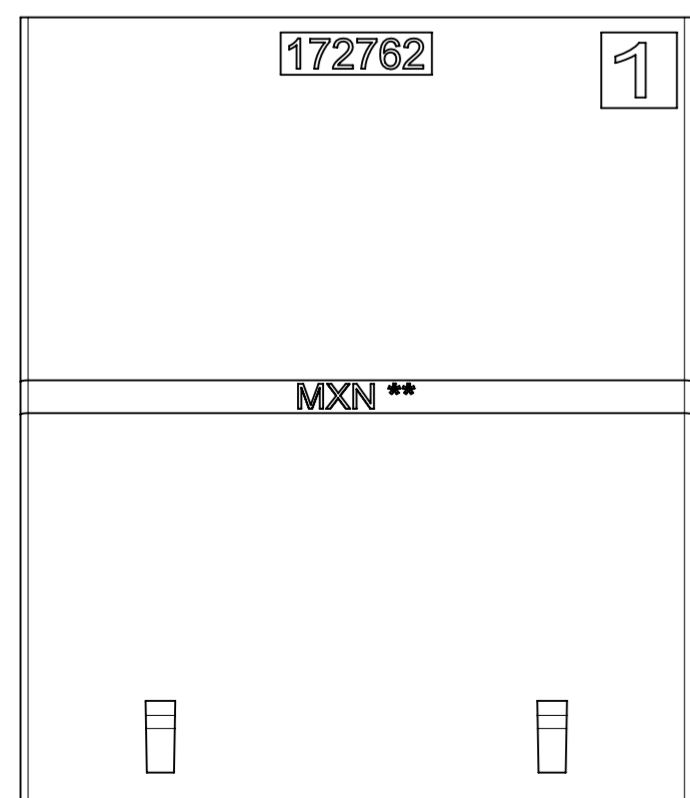
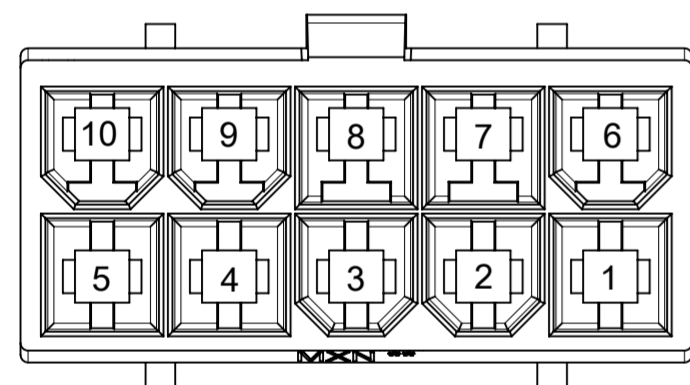

10-CKT

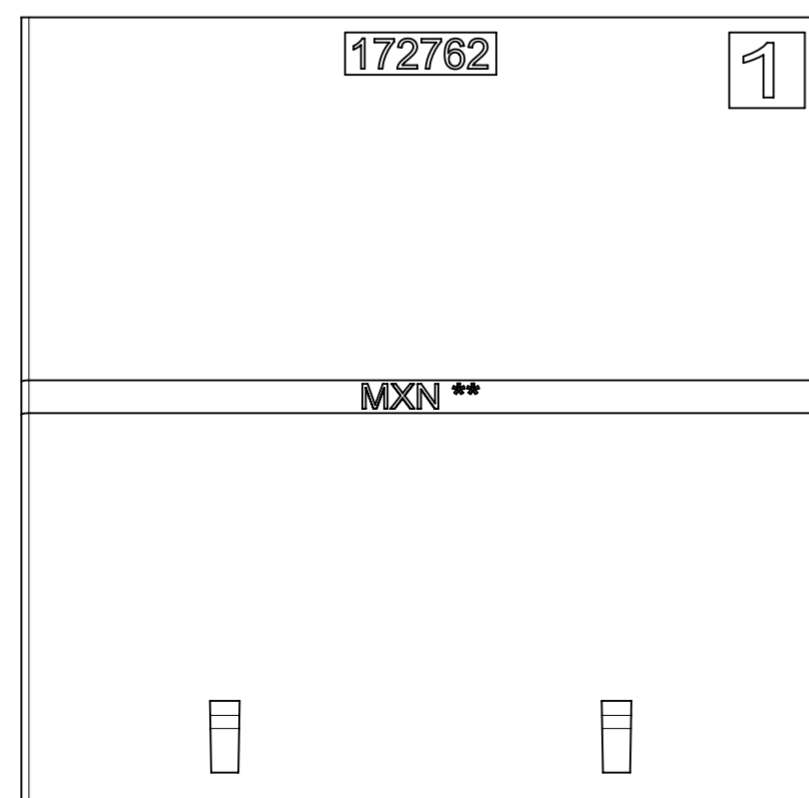
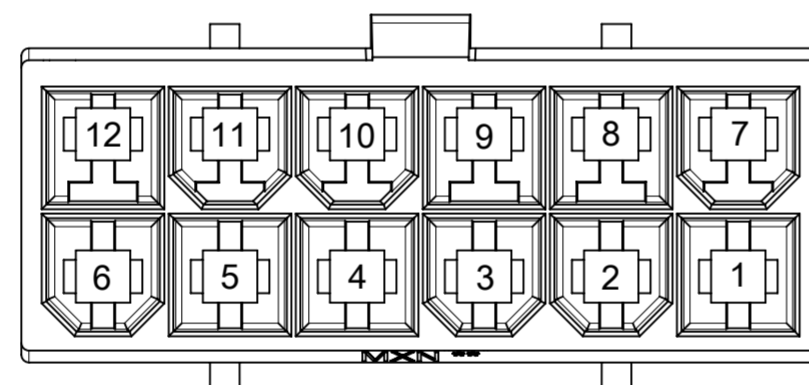

12-CKT

THIS DRAWING CONTAINS INFORMATION THAT IS PROPRIETARY TO MOLEX ELECTRONIC TECHNOLOGIES, LLC AND SHOULD NOT BE USED WITHOUT WRITTEN PERMISSION													
DIMENSION UNITS		SCALE		CURRENT REV DESC:									
mm		NTS											
GENERAL TOLERANCES (UNLESS SPECIFIED)				EC NO: 768511						SD-DRAWING OF MINI-FIT SIGMA DR PLUG			
ANGULAR TOL ± °				DRWN: JERRYW8 2023/11/02									
4 PLACES ±				CHK'D: XQZHANG 2023/11/15						PRODUCT CUSTOMER DRAWING			
3 PLACES ±				APPR: XQZHANG 2023/11/15									
2 PLACES ± 0.25				INITIAL REVISION:						DOCUMENT NUMBER			
1 PLACE ± 0.36				DRWN: ALUO02 2019/09/18									
0 PLACES ±				APPR: YXZHENG 2019/10/11						1727620001-SD			
DRAFT WHERE APPLICABLE MUST REMAIN WITHIN DIMENSIONS		THIRD ANGLE PROJECTION		DRAWING		SERIES		MATERIAL NUMBER		CUSTOMER		SHEET NUMBER	
				A2-SIZE		172762		SEE TABLE		GENERAL MARKET		3 OF 4	

**molex**

SD-DRAWING OF MINI-FIT SIGMA DR PLUG

PRODUCT CUSTOMER DRAWING

DOCUMENT NUMBER: 1727620001-SD | DOC TYPE: PSD | DOC PART: 000 | REVISION: A6

MATERIAL NUMBER: SEE TABLE | CUSTOMER: GENERAL MARKET | SHEET NUMBER: 3 OF 4

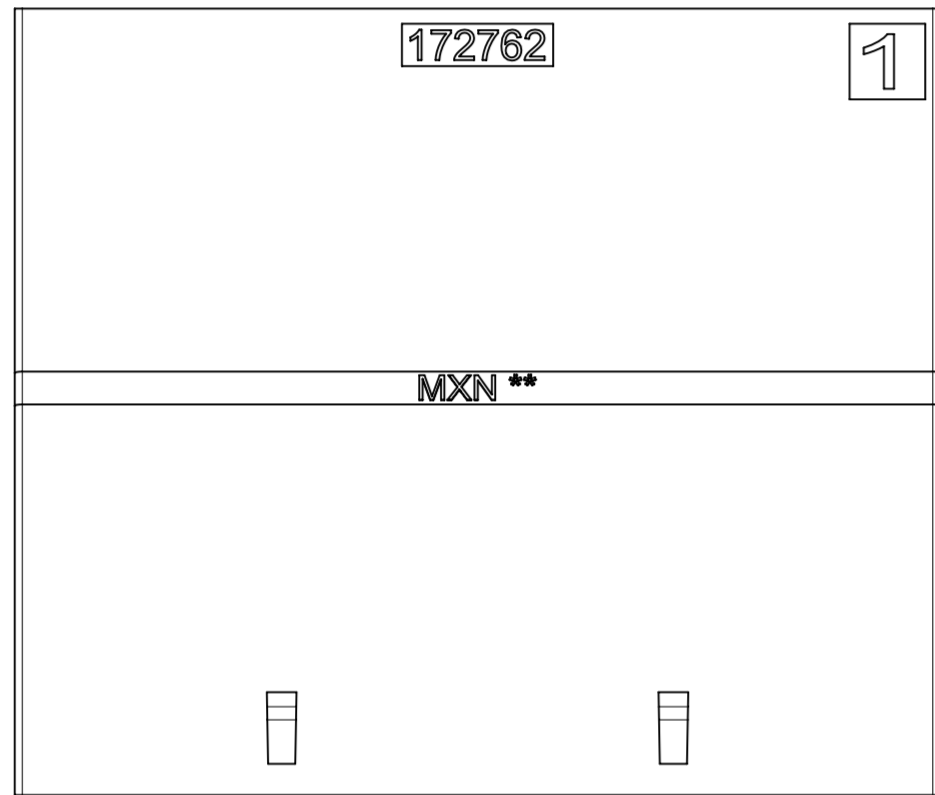
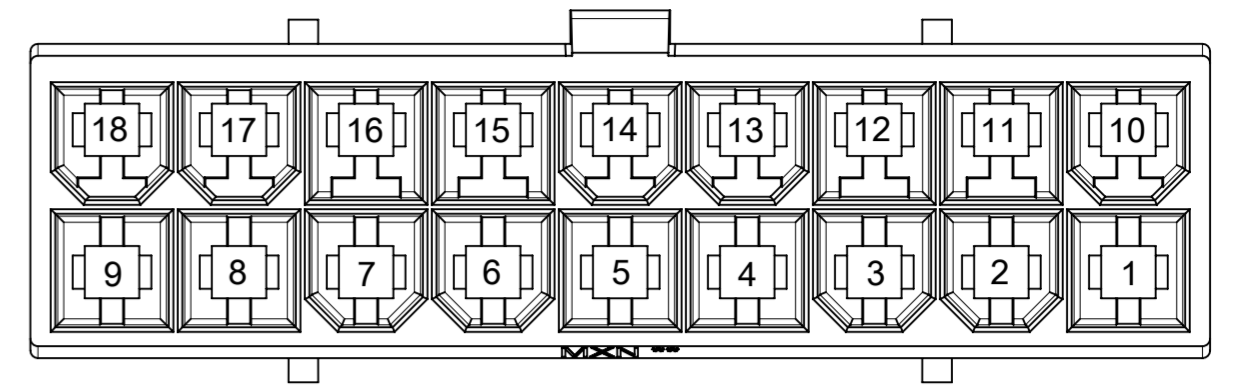
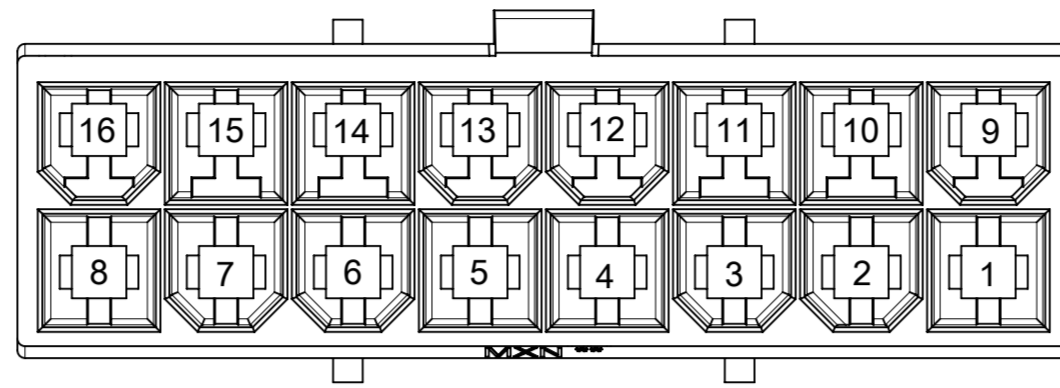
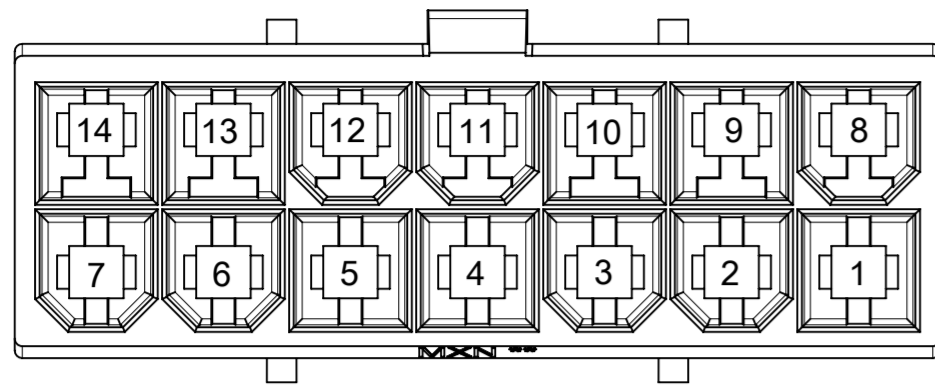

14-CKT

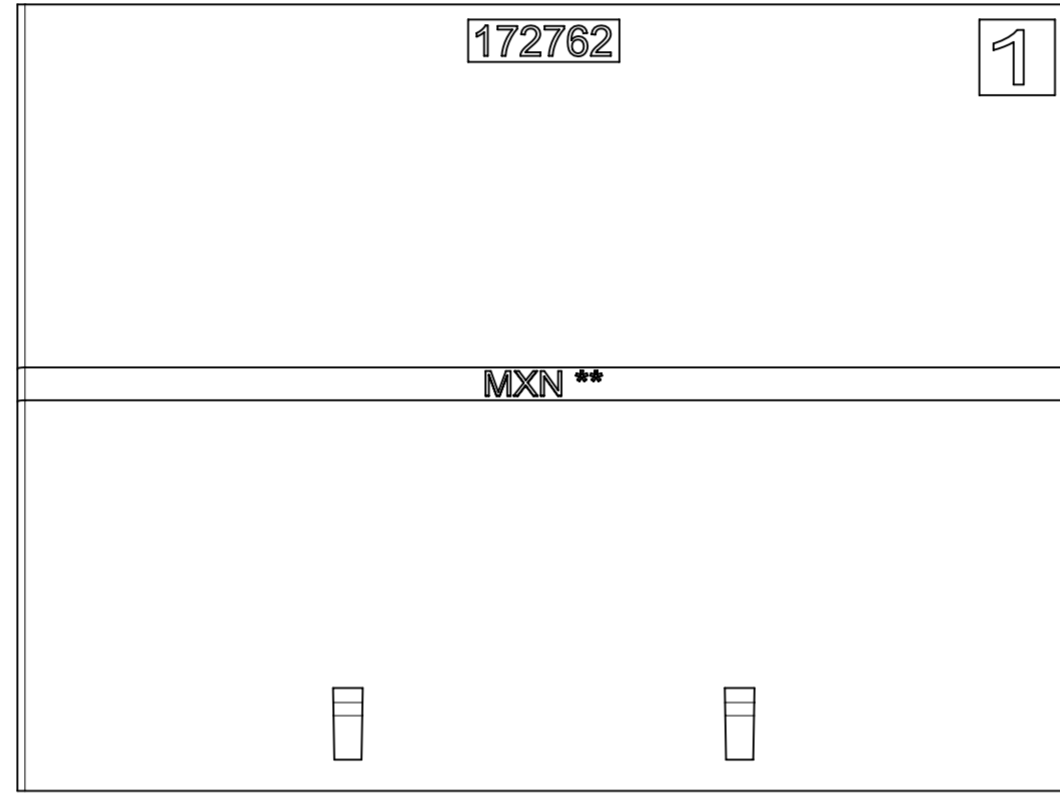

16-CKT

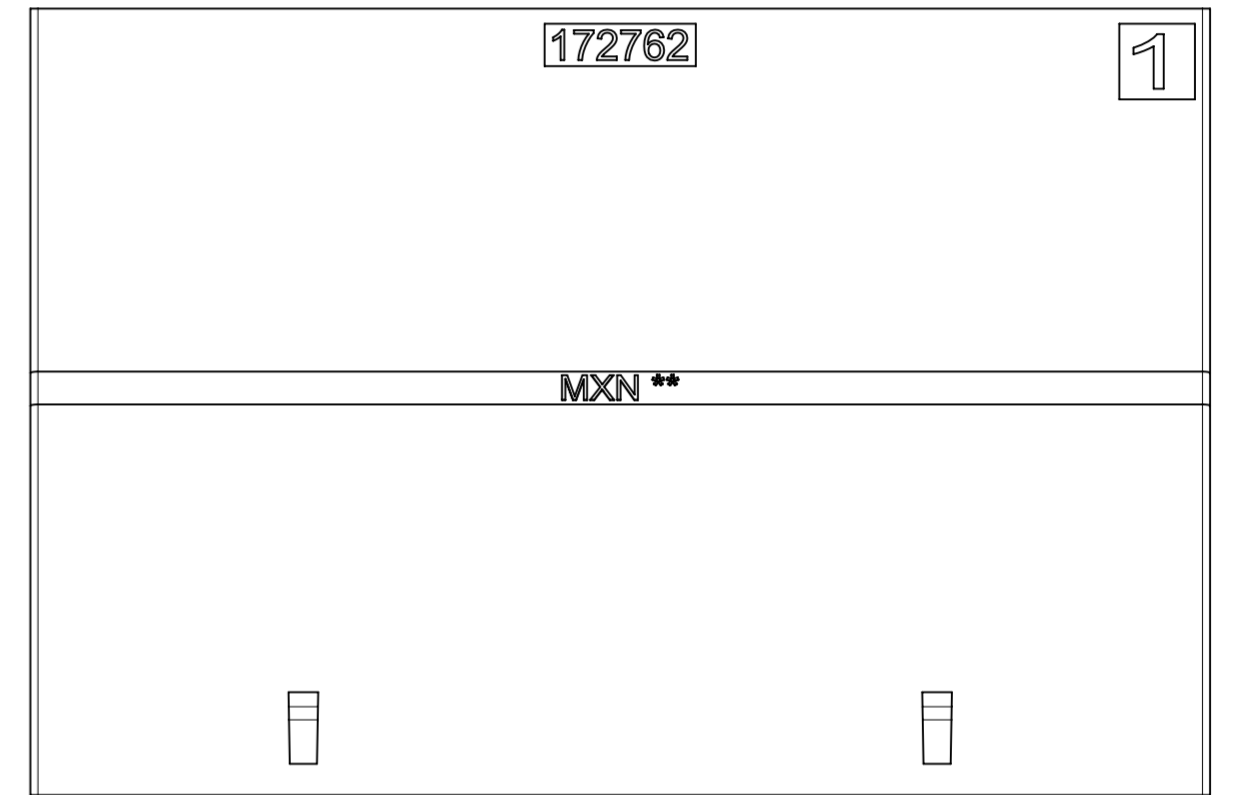

18-CKT

THIS DRAWING CONTAINS INFORMATION THAT IS PROPRIETARY TO MOLEX ELECTRONIC TECHNOLOGIES, LLC AND SHOULD NOT BE USED WITHOUT WRITTEN PERMISSION

DIMENSION UNITS	SCALE	CURRENT REV DESC:		<b>molex</b>			
mm	NTS						
GENERAL TOLERANCES (UNLESS SPECIFIED)				SD-DRAWING OF MINI-FIT SIGMA DR PLUG			
ANGULAR TOL	±	°		PRODUCT CUSTOMER DRAWING			
4 PLACES	±			DOCUMENT NUMBER			
3 PLACES	±			1727620001-SD			
2 PLACES	±	0.25		DOC TYPE			
1 PLACE	±	0.36		PSD			
0 PLACES	±			DOC PART			
DRAFT WHERE APPLICABLE MUST REMAIN WITHIN DIMENSIONS				REVISION			
THIRD ANGLE PROJECTION				000			
DRAWING				A6			
SERIES				MATERIAL NUMBER			
A2-SIZE				SEE TABLE			
172762				CUSTOMER			
GENERAL MARKET				SHEET NUMBER			
				4 OF 4			