

- 注記
NOTES
- 材質
ハウジング：耐熱性ナイロンUL94V-0
ピン：銅合金、ニッケル下地、錫メッキ、金メッキ
フィッティングネール：銅合金、ニッケル下地、錫メッキ
MATERIAL
HOUSING:POLYAMIDE UL94V-0
PIN: COPPER ALLOY, GOLD OR TIN OVER NICKEL PLATE.
FITTING NAIL: COPPER ALLOY, TIN OVER NICKEL PLATE.
 - 色：ナチュラル、黒、赤、青
COLOR:NATURAL, BLACK, RED, BLUE
 - 嵌合相手
ハウジング：502351-**0*
錫メッキ端子：50212-8*00,50372-8*00,560085-0101
金メッキ端子：56161-8*81
MATES WITH
HOUSING:502351-**0*
SN PLATING TERMINAL:50212-8*00,50372-8*00,560085-0101
AU PLATING TERMINAL:56161-8*81
 - エンボス梱包品の詳細はSD-502352-002参照
DETAILED TAPING PACKAGE, SEE SD-502352-002.
 - ELV及びRoHS適合
ELV AND RoHS COMPLIANT
 - 半田付け面のコプラナリティ：0.1mm MAX.
CO-PLANARITY OF SOLDERING TAILS TO BE 0.1mm MAX.

- 7.一般公差
GENERAL TOLERANCES
10 UNDER: ±0.2
10 OVER 30 UNDER: ±0.25
30 OVER: ±0.3
ANGULAR: ±3°

INITIAL REVISION:
DRWN SHSHIBATA 2007/12/18
CHECK HKOMATSU 2007/12/18
APPR AKANESHIGE 2007/12/18

FUNCTIONAL SYMBOLS ▽A=0 ▽B=0 ▽C=0 DIVISIONAL SYMBOLS	THIS DRAWING CONTAINS INFORMATION THAT IS PROPRIETARY TO MOLEX ELECTRONIC TECHNOLOGIES, LLC AND SHOULD NOT BE USED WITHOUT WRITTEN PERMISSION		CURRENT REV DESC: For fixing wrong view of 6ckt		
	FUNCTIONAL DIMENSION UNITS	SCALE	molex		
	mm	5:1	2.0MM PITCH W/B CONN. WAFER ASSY R/A SMT		
	GENERAL TOLERANCES (UNLESS SPECIFIED)		PRODUCT SALES DRAWING		
ANGULAR TOL ± 0.5°		DOCUMENT NUMBER			
4 PLACES ±		SD-502352-001		DOC TYPE	
3 PLACES ±		PSD		DOC PART	
2 PLACES ±		001		REVISION	
1 PLACE ±		L4			
0 PLACES ±					
DRAFT WHERE APPLICABLE MUST REMAIN WITHIN DIMENSIONS		THIRD ANGLE PROJECTION	DRAWING	SERIES	
		⊕	A3-SIZE	502352	
		STATUS: Production	DRWN: Hideo Yoneyama	2024-05-14	
		CHK'D: Hiromichi Komatsu	2024-05-16	2024-05-16	
		APPR: Takashi Iida			
		MATERIAL NUMBER	CUSTOMER	SHEET NUMBER	
		SEE CHART	GENERAL MARKET	1 OF 4	

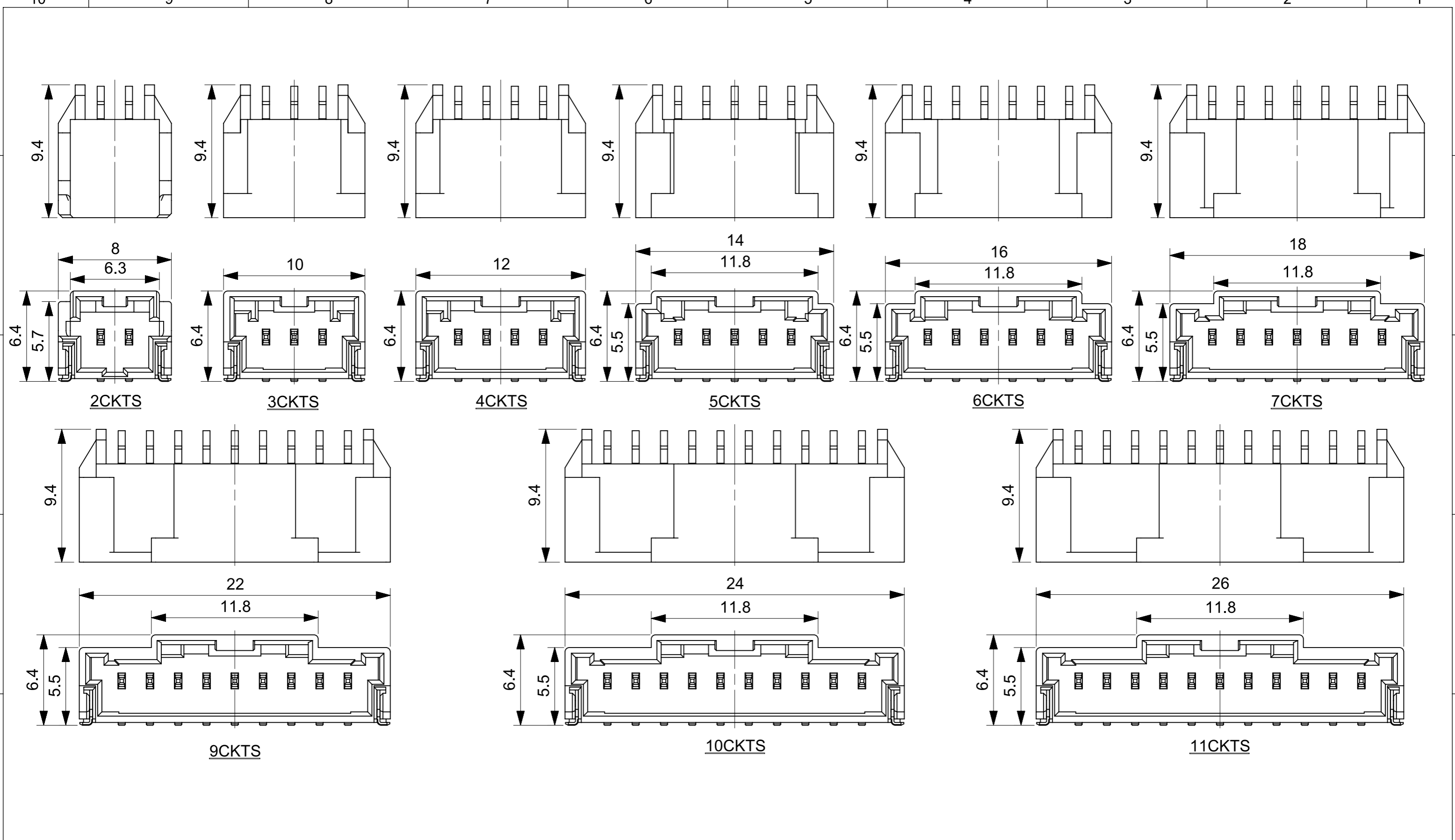

INITIAL REVISION:
 DRWN SHSHIBATA 2007/12/18
 CHECK HKOMATSU 2007/12/18
 APPR AKANESHIGE 2007/12/18

FUNCTIONAL SYMBOLS $\nabla_A = 0$ $\nabla_B = 0$ $\nabla_C = 0$ DIVISIONAL SYMBOLS	THIS DRAWING CONTAINS INFORMATION THAT IS PROPRIETARY TO MOLEX ELECTRONIC TECHNOLOGIES, LLC AND SHOULD NOT BE USED WITHOUT WRITTEN PERMISSION CURRENT REV DESC: For fixing wrong view of 6ckt		molex 2.0MM PITCH W/B CONN. WAFER ASSY R/A SMT					
	DIMENSION UNITS mm	SCALE 4:1				PRODUCT SALES DRAWING		
	GENERAL TOLERANCES (UNLESS SPECIFIED) ANGULAR TOL $\pm 0.5^\circ$ 4 PLACES \pm 3 PLACES \pm 2 PLACES \pm 1 PLACE \pm 0 PLACES \pm		STATUS: Production DRWN: Hideo Yoneyama CHK'D: Hiromichi Komatsu APPR: Takashi Iida	2024-05-14 2024-05-16 2024-05-16	DOCUMENT NUMBER SD-502352-001	DOC TYPE PSD	DOC PART 001	REVISION L4
	DRAFT WHERE APPLICABLE MUST REMAIN WITHIN DIMENSIONS		THIRD ANGLE PROJECTION 	DRAWING A3-SIZE	SERIES 502352	MATERIAL NUMBER SEE CHART	CUSTOMER GENERAL MARKET	SHEET NUMBER 2 OF 4

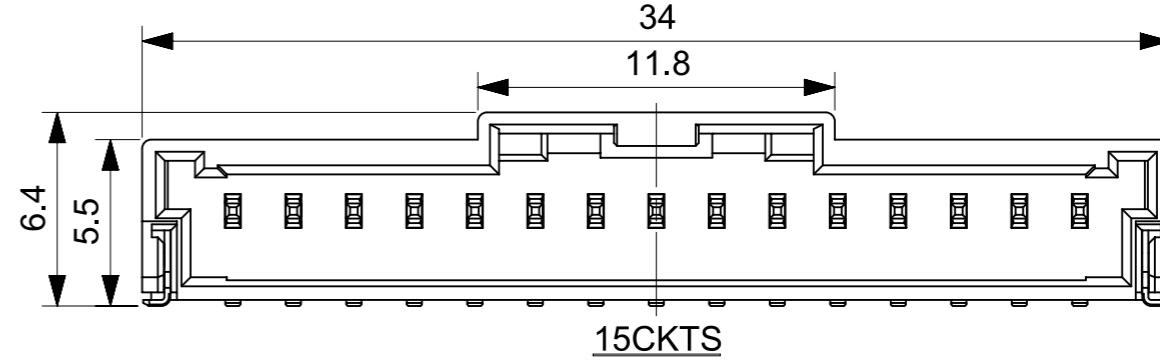
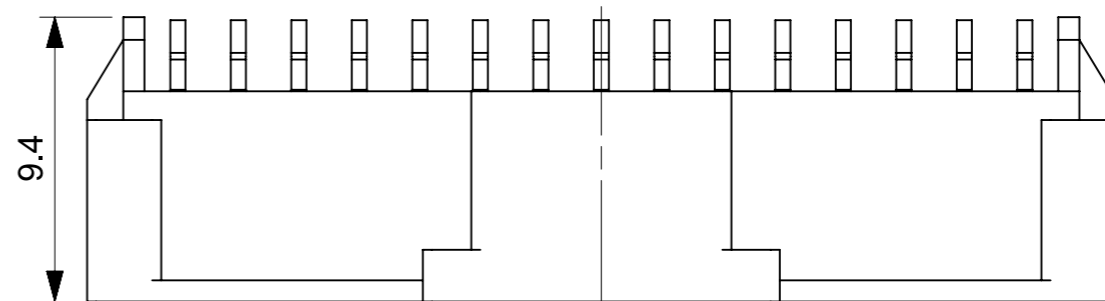
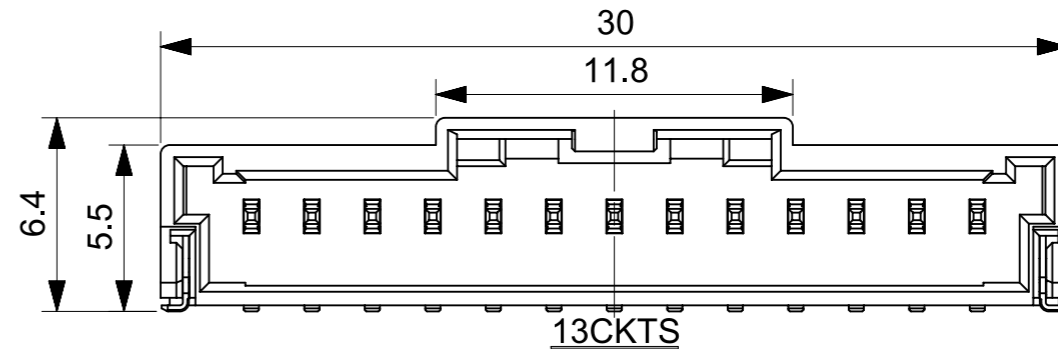
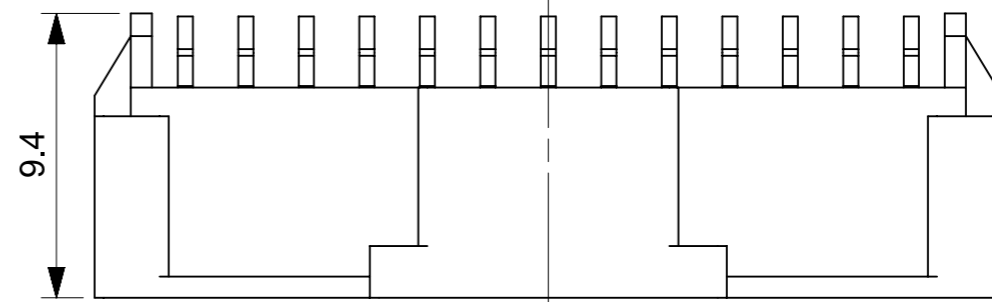
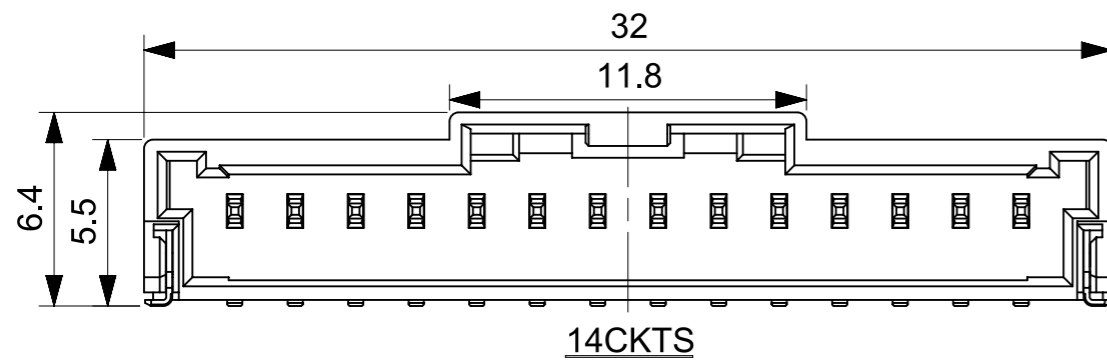
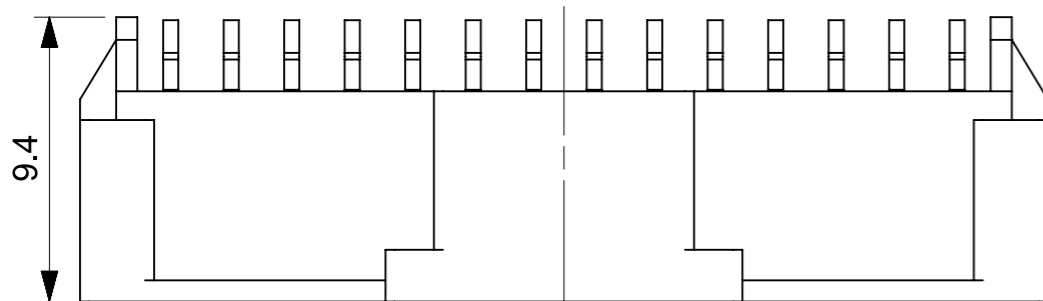
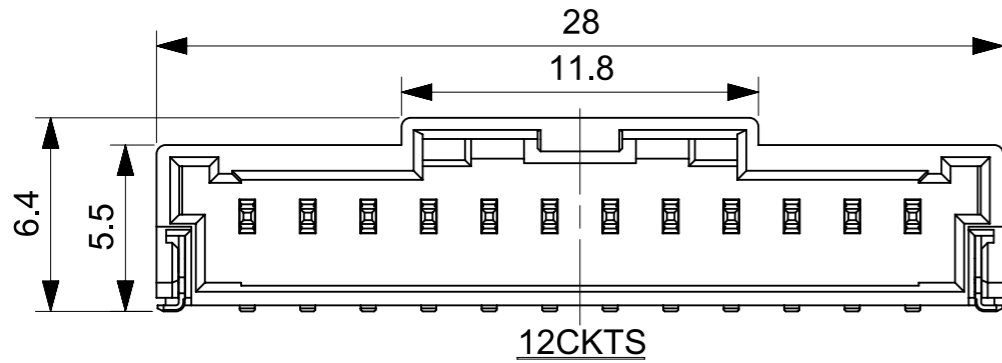
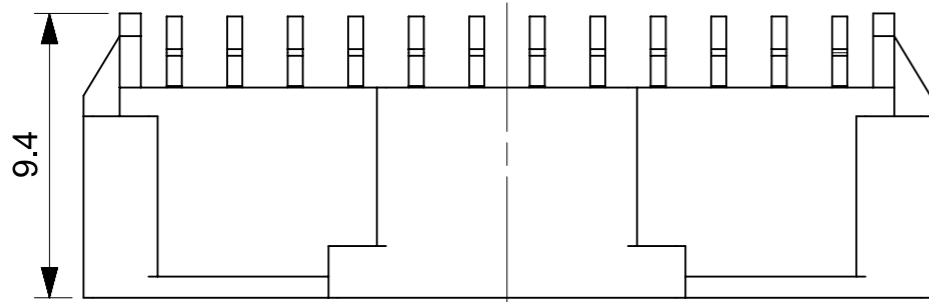

INITIAL REVISION:
 DRWN SHSHIBATA 2007/12/18
 CHECK HKOMATSU 2007/12/18
 APPR AKANESHIGE 2007/12/18

FUNCTIONAL SYMBOLS $\nabla/A = 0$ $\nabla/B = 0$ $\nabla/C = 0$ DIVISIONAL SYMBOLS	THIS DRAWING CONTAINS INFORMATION THAT IS PROPRIETARY TO MOLEX ELECTRONIC TECHNOLOGIES, LLC AND SHOULD NOT BE USED WITHOUT WRITTEN PERMISSION CURRENT REV DESC: For fixing wrong view of 6ckt	
	DIMENSION UNITS mm	SCALE 4:1
	GENERAL TOLERANCES (UNLESS SPECIFIED) ANGULAR TOL $\pm 0.5^\circ$ 4 PLACES \pm 3 PLACES \pm 2 PLACES \pm 1 PLACE \pm 0 PLACES \pm	
	DRAFT WHERE APPLICABLE MUST REMAIN WITHIN DIMENSIONS THIRD ANGLE PROJECTION 	
STATUS: Production DRWN: Hideo Yoneyama 2024-05-14 CHK'D: Hiromichi Komatsu 2024-05-16 APPR: Takashi Iida 2024-05-16		DOCUMENT NUMBER SD-502352-001
DRAWING A3-SIZE		SERIES 502352
MATERIAL NUMBER SEE CHART		CUSTOMER GENERAL MARKET
SHEET NUMBER 3 OF 4		DOC TYPE DOC PART REVISION PSD 001 L4

molex

2.0MM PITCH W/B CONN.
 WAFER ASSY R/A SMT

PRODUCT SALES DRAWING

Sn NATURAL	34.0	502352-1500	15
	32.0	502352-1400	14
	30.0	502352-1300	13
	28.0	502352-1200	12
	26.0	502352-1100	11
	24.0	502352-1000	10
	22.0	502352-0900	9
	20.0	502352-0800	8
	18.0	502352-0700	7
	16.0	502352-0600	6
	14.0	502352-0500	5
	12.0	502352-0400	4
10.0	502352-0300	3	
8.0	502352-0200	2	
PLATING COLOR	A	EMBOSSSED PACKAGE ORDER NO.	CKTS
CONNECTOR SERIES NO. 502352-**08			

Au NATURAL	34.0	502352-1510	15
	32.0	502352-1410	14
	30.0	502352-1310	13
	28.0	502352-1210	12
	26.0	502352-1110	11
	24.0	502352-1010	10
	22.0	502352-0910	9
	20.0	502352-0810	8
	18.0	502352-0710	7
	16.0	502352-0610	6
	14.0	502352-0510	5
	12.0	502352-0410	4
10.0	502352-0310	3	
8.0	502352-0210	2	
PLATING COLOR	A	EMBOSSSED PACKAGE ORDER NO.	CKTS
CONNECTOR SERIES NO. 502352-**18			

Sn BLACK	34.0	502352-1501	15
	32.0	502352-1401	14
	30.0	502352-1301	13
	28.0	502352-1201	12
	26.0	502352-1101	11
	24.0	502352-1001	10
	22.0	502352-0901	9
	20.0	502352-0801	8
	18.0	502352-0701	7
	16.0	502352-0601	6
	14.0	502352-0501	5
	12.0	502352-0401	4
10.0	502352-0301	3	
8.0	502352-0201	2	
PLATING COLOR	A	EMBOSSSED PACKAGE ORDER NO.	CKTS
CONNECTOR SERIES NO. 502352-**28			

Sn RED	-	-	15
	-	-	14
	-	-	13
	-	-	12
	-	-	11
	-	-	10
	-	-	9
	20.0	502352-0802	8
	-	-	7
	16.0	502352-0602	6
	-	-	5
	12.0	502352-0402	4
10.0	502352-0302	3	
8.0	502352-0202	2	
PLATING COLOR	A	EMBOSSSED PACKAGE ORDER NO.	CKTS
CONNECTOR SERIES NO. 502352-**48			

Sn BLUE	-	-	15
	-	-	14
	-	-	13
	-	-	12
	-	-	11
	-	-	10
	-	-	9
	20.0	502352-0803	8
	-	-	7
	16.0	502352-0603	6
	-	-	5
	12.0	502352-0403	4
10.0	502352-0303	3	
8.0	502352-0203	2	
PLATING COLOR	A	EMBOSSSED PACKAGE ORDER NO.	CKTS
CONNECTOR SERIES NO. 502352-**68			

INITIAL REVISION:
 DRWN SHSHIBATA 2007/12/18
 CHECK HKOMATSU 2007/12/18
 APPR AKANESHIGE 2007/12/18

FUNCTIONAL SYMBOLS				THIS DRAWING CONTAINS INFORMATION THAT IS PROPRIETARY TO MOLEX ELECTRONIC TECHNOLOGIES, LLC AND SHOULD NOT BE USED WITHOUT WRITTEN PERMISSION							
DIMENSION UNITS		SCALE		CURRENT REV DESC: For fixing wrong view of 6ckt							
mm		1:1									
GENERAL TOLERANCES (UNLESS SPECIFIED)											
ANGULAR TOL ± 0.5°											
4 PLACES ±											
3 PLACES ±											
2 PLACES ±											
1 PLACE ±											
0 PLACES ±											
DRAFT WHERE APPLICABLE MUST REMAIN WITHIN DIMENSIONS											
THIRD ANGLE PROJECTION		DRAWING		SERIES		MATERIAL NUMBER		CUSTOMER		SHEET NUMBER	
		A3-SIZE		502352		SEE CHART		GENERAL MARKET		4 OF 4	
STATUS: Production											
DRWN: Hideo Yoneyama				2024-05-14							
CHK'D: Hiromichi Komatsu				2024-05-16							
APPR: Takashi Iida				2024-05-16							
DOCUMENT NUMBER				DOC TYPE		DOC PART		REVISION			
SD-502352-001				PSD		001		L4			



2.0MM PITCH W/B CONN.
 WAFER ASSY R/A SMT

PRODUCT SALES DRAWING

注記
NOTES

- 製品番号
 ナチュラル・錫めっき: 502352-**00
 ナチュラル・金めっき: 502352-**10
 黒・錫めっき: 502352-**01
 赤・錫めっき: 502352-**02
 青・錫めっき: 502352-**03
 詳細寸法については、製品単体図面を参照下さい。
 PART NO.
 NATURAL Sn Plating: 502352-**00
 NATURAL Au Plating: 502352-**10
 BLACK Sn Plating: 502352-**01
 RED Sn Plating: 502352-**02
 BLUE Sn Plating: 502352-**03
 SEE SALES DRAWING FOR CONNECTOR
- 梱包数量: 700個/リール
 NUMBER OF CONNECTORS 700PCS/REEL
- リードテープ長さ
 LEAD TAPE LENGHT
- 材料
 MATERIAL
 キャリアテープ: ポリスチレン
 CARRIER TAPE: POLYSTYRENE
 トップテープ: PET, PE, PEF
 TOP TAPE: PET, PE, PEF
 リール: ポリスチレン
 REEL: POLYSTYRENE
- 一般公差
 GENERAL TOLERANCES
 10 UNDER: ±0.2
 10 OVER 30 UNDER: ±0.25
 30 OVER: ±0.3
 ANGULAR: ±1°

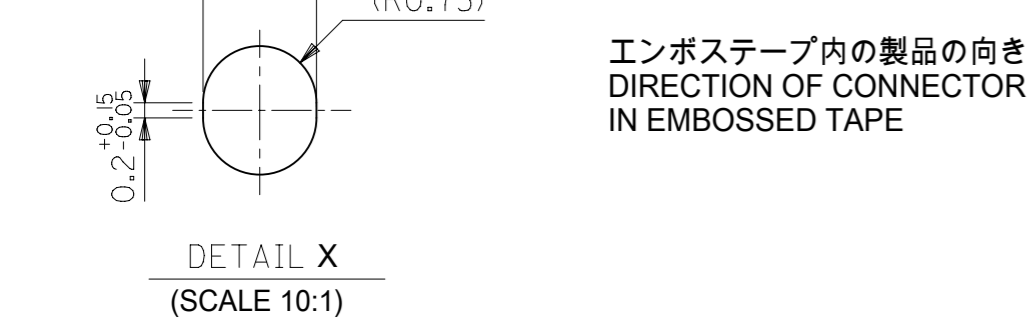
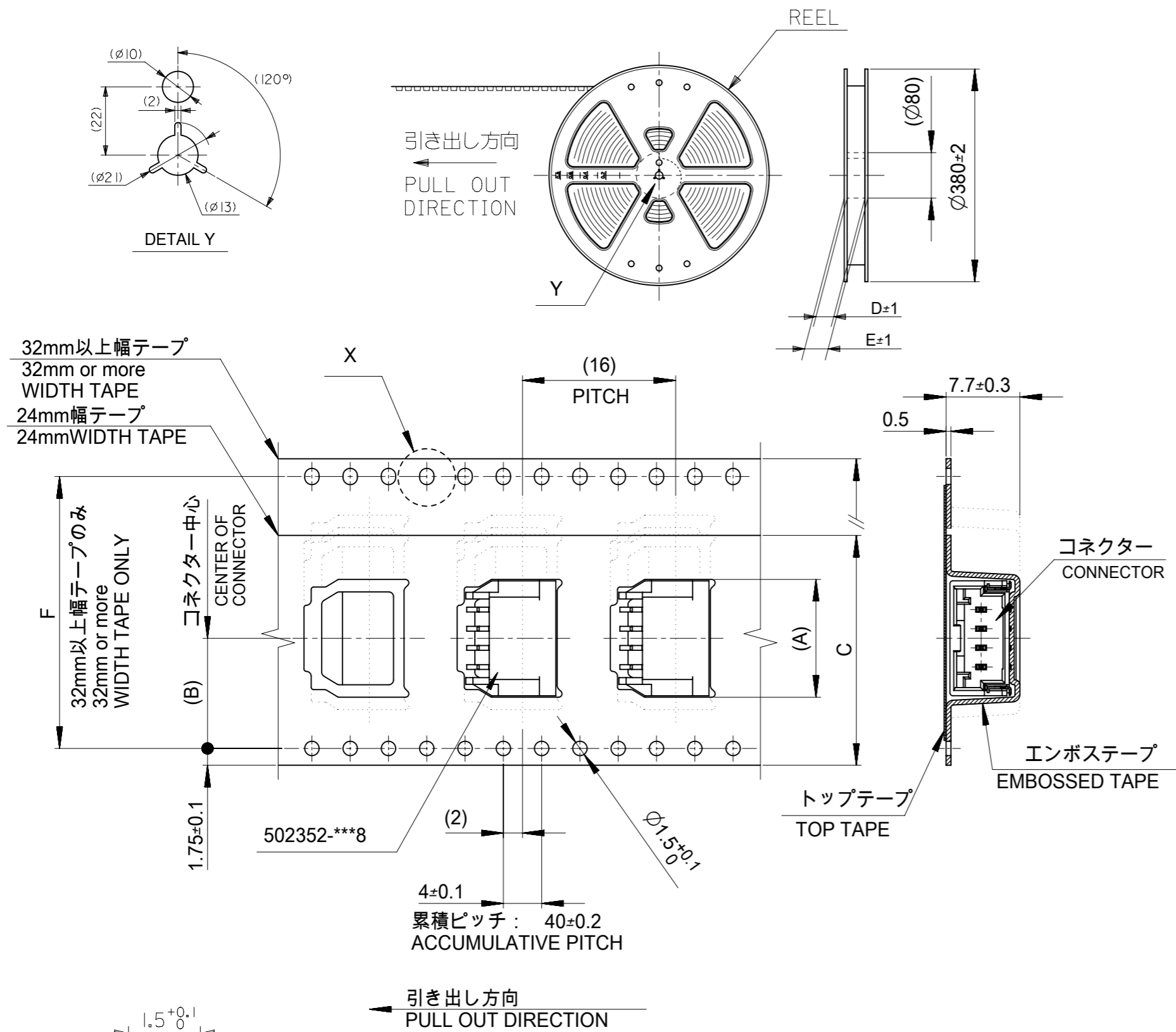
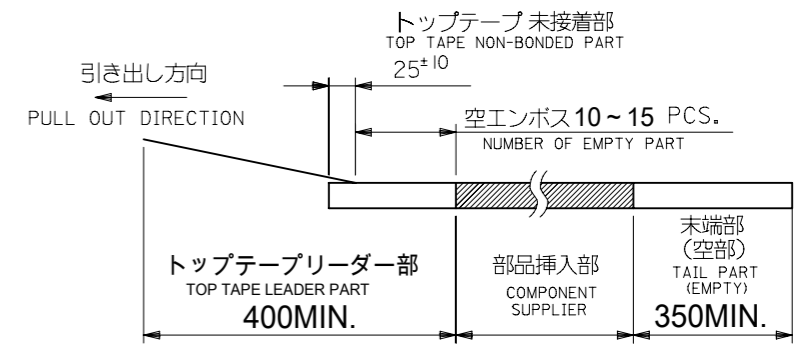

引き出し方向
PULL OUT DIRECTION

エンボステープ内の製品の向き
DIRECTION OF CONNECTOR
IN EMBOSSED TAPE

THIS DRAWING CONTAINS INFORMATION THAT IS PROPRIETARY TO MOLEX ELECTRONIC TECHNOLOGIES, LLC AND SHOULD NOT BE USED WITHOUT WRITTEN PERMISSION		CURRENT REV DESC:		molex	
DIMENSION UNITS	SCALE				
mm	NTS			2.0MM PITCH W/B CONN. WAFER ASSY EMBOSSED TAPE PACKAGE	
GENERAL TOLERANCES (UNLESS SPECIFIED)		EC NO: 629663		PRODUCT CUSTOMER DRAWING	
ANGULAR TOL	± °	DRWN: MSATO08	2019/12/26	DOCUMENT NUMBER	
4 PLACES	±	CHK'D: HIJIMA	2019/12/27	SD-502352-002	
3 PLACES	±	APPR: TOSADA	2019/12/27	DOC TYPE	DOC PART
2 PLACES	±	INITIAL REVISION:		PSD	001
1 PLACE	±	DRWN: SHSHIBATA	2007/06/19	REVISION	
0 PLACES	±	APPR: AKANESHIGE	2007/06/19	K2	
DRAFT WHERE APPLICABLE MUST REMAIN WITHIN DIMENSIONS		THIRD ANGLE PROJECTION	DRAWING	SERIES	MATERIAL NUMBER
			A3-SIZE	502352	CUSTOMER
					GENERAL MARKET
					SHEET NUMBER
					1 OF 2

INITIAL REVISION:

DRWN	SHSHIBATA	2007/06/06
CHECK	TAITO	2007/06/06
APPR	MAYAMAMOTO	2012/03/14

E	Sn NATURAL	52.4	61.4	57.4	56	26.2	34.3	502352-1500	15	Au NATURAL	52.4	61.4	57.4	56	26.2	34.3	502352-1510	15
							32.3	502352-1400	14							32.3	502352-1410	14
		40.4	49.4	45.4	44	20.2	30.3	502352-1300	13		40.4	49.4	45.4	44	20.2	30.3	502352-1310	13
							28.3	502352-1200	12							28.3	502352-1210	12
							26.3	502352-1100	11							26.3	502352-1110	11
							24.3	502352-1000	10							24.3	502352-1010	10
							22.3	502352-0900	9							22.3	502352-0910	9
		28.4	37.4	33.4	32	14.2	20.3	502352-0800	8		28.4	37.4	33.4	32	14.2	20.3	502352-0810	8
							18.3	502352-0700	7							18.3	502352-0710	7
							16.3	502352-0600	6							16.3	502352-0610	6
							14.3	502352-0500	5							14.3	502352-0510	5
							12.3	502352-0400	4							12.3	502352-0410	4
		/	29.4	25.4	24	11.5	10.3	502352-0300	3		/	29.4	25.4	24	11.5	10.3	502352-0310	3
							8.3	502352-0200	2							8.3	502352-0210	2
							PLATING COLOR									F	E	D

C	Sn BLACK	52.4	61.4	57.4	56	26.2	34.3	502352-1501	15	Sn RED	/	/	/	/	/	/	/	15
							32.3	502352-1401	14									14
		40.4	49.4	45.4	44	20.2	30.3	502352-1301	13		40.4	49.4	45.4	44	20.2			13
							28.3	502352-1201	12							28.3	502352-1201	12
							26.3	502352-1101	11							26.3	502352-1101	11
							24.3	502352-1001	10							24.3	502352-1001	10
							22.3	502352-0901	9							22.3	502352-0901	9
		28.4	37.4	33.4	32	14.2	20.3	502352-0801	8		28.4	37.4	33.4	32	14.2	20.3	502352-0802	8
							18.3	502352-0701	7							18.3	502352-0701	7
							16.3	502352-0601	6							16.3	502352-0602	6
							14.3	502352-0501	5							14.3	502352-0501	5
							12.3	502352-0401	4							12.3	502352-0402	4
		/	29.4	25.4	24	11.5	10.3	502352-0301	3		/	29.4	25.4	24	11.5	10.3	502352-0302	3
							8.3	502352-0201	2							8.3	502352-0202	2
							PLATING COLOR									F	E	D

THIS DRAWING CONTAINS INFORMATION THAT IS PROPRIETARY TO MOLEX ELECTRONIC TECHNOLOGIES, LLC AND SHOULD NOT BE USED WITHOUT WRITTEN PERMISSION

DIMENSION UNITS mm	SCALE NTS	CURRENT REV DESC:	
GENERAL TOLERANCES (UNLESS SPECIFIED)		molex	
ANGULAR TOL ±	*	2.0MM PITCH W/B CONN. WAFER ASSY EMBOSSED TAPE PACKAGE	
4 PLACES ±		PRODUCT CUSTOMER DRAWING	
3 PLACES ±		DOCUMENT NUMBER SD-502352-002	
2 PLACES ±		DOC TYPE PSD	DOC PART 001
1 PLACE ±		REVISION K2	
0 PLACES ±		MATERIAL NUMBER SEE CHART	
DRAFT WHERE APPLICABLE MUST REMAIN WITHIN DIMENSIONS		THIRD ANGLE PROJECTION 	DRAWING A3-SIZE
INITIAL REVISION:		SERIES 502352	CUSTOMER GENERAL MARKET
DRWN SHSHIBATA	2007/06/06	SHEET NUMBER 2 OF 2	
CHECK TAITO	2007/06/06		
APPR MAYAMAMOTO	2012/03/14		