

- 注記  
NOTES
- 材質  
ハウジング：耐熱性ナイロンUL94V-0  
ピン：銅合金、ニッケル下地、錫メッキ、金メッキ  
フィッティングネール：銅合金、ニッケル下地、錫メッキ  
MATERIAL  
HOUSING:POLYAMIDE UL94V-0  
PIN: COPPER ALLOY, GOLD OR TIN OVER NICKEL PLATE.  
FITTING NAIL: COPPER ALLOY, TIN OVER NICKEL PLATE.
  - 色：ナチュラル、黒、赤、青  
COLOR:NATURAL, BLACK, RED, BLUE
  - 嵌合相手  
ハウジング：502351-\*\*0\*  
錫メッキ端子：50212-8\*00,50372-8\*00,560085-0101  
金メッキ端子：56161-8\*81  
MATES WITH  
HOUSING:502351-\*\*0\*  
SN PLATING TERMINAL:50212-8\*00,50372-8\*00,560085-0101  
AU PLATING TERMINAL:56161-8\*81
  - エンボス梱包品の詳細はSD-502352-002参照  
DETAILED TAPING PACKAGE, SEE SD-502352-002.
  - ELV及びRoHS適合  
ELV AND RoHS COMPLIANT
  - 半田付け面のコプラナリティ：0.1mm MAX.  
CO-PLANARITY OF SOLDERING TAILS TO BE 0.1mm MAX.

- 7.一般公差  
GENERAL TOLERANCES  
10 UNDER: ±0.2  
10 OVER 30 UNDER: ±0.25  
30 OVER: ±0.3  
ANGULAR: ±3°

INITIAL REVISION:  
DRWN SHSHIBATA 2007/12/18  
CHECK HKOMATSU 2007/12/18  
APPR AKANESHIGE 2007/12/18

FUNCTIONAL SYMBOLS A=0 B=0 C=0 D=0 E=0 F=0	THIS DRAWING CONTAINS INFORMATION THAT IS PROPRIETARY TO MOLEX ELECTRONIC TECHNOLOGIES, LLC AND SHOULD NOT BE USED WITHOUT WRITTEN PERMISSION		CURRENT REV DESC: For fixing wrong view of 6ckt	
	DIMENSION UNITS mm	SCALE 5:1		
DIVISIONAL SYMBOLS	GENERAL TOLERANCES (UNLESS SPECIFIED)			
	ANGULAR TOL ± 0.5°			
	4 PLACES	±		
	3 PLACES	±		
	2 PLACES	±		
	1 PLACE	±		
	0 PLACES	±		
DRAFT WHERE APPLICABLE MUST REMAIN WITHIN DIMENSIONS		THIRD ANGLE PROJECTION	DRAWING A3-SIZE	SERIES 502352
STATUS: Production		DRWN: Hideo Yoneyama	2024-05-14	DOCUMENT NUMBER
CHK'D: Hiromichi Komatsu		2024-05-16	2024-05-16	SD-502352-001
APPR: Takashi Iida		2024-05-16	2024-05-16	PSD 001 L4
MATERIAL NUMBER SEE CHART		CUSTOMER GENERAL MARKET	SHEET NUMBER 1 OF 4	

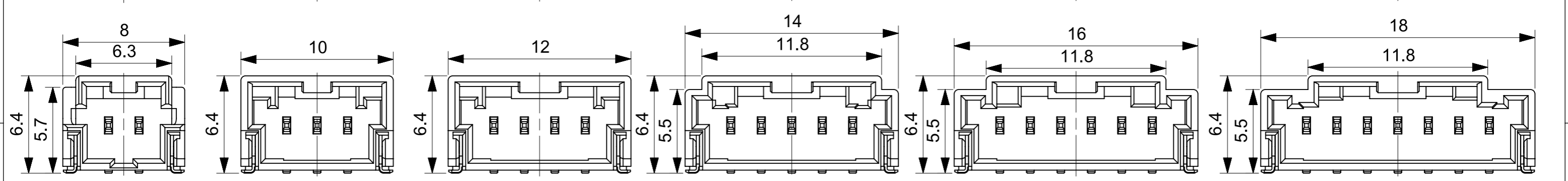
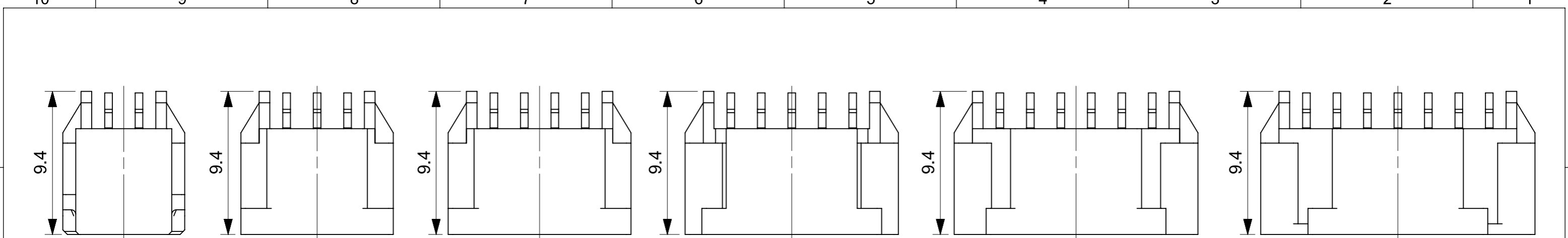

2CKTS

3CKTS

4CKTS

5CKTS

6CKTS

7CKTS

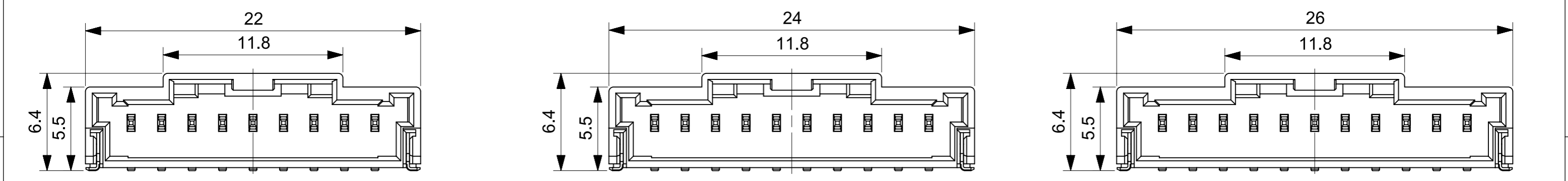
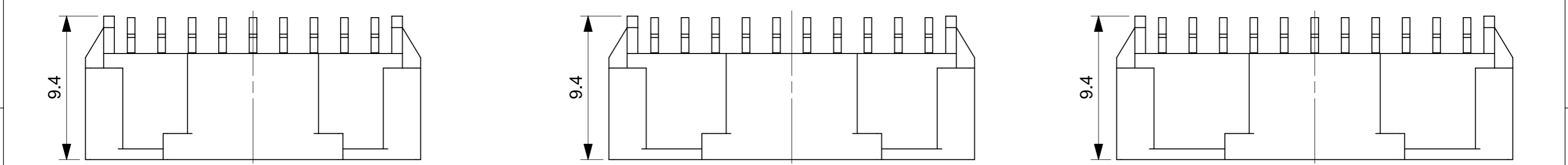

9CKTS

10CKTS

11CKTS

INITIAL REVISION:  
 DRWN SHSHIBATA 2007/12/18  
 CHECK HKOMATSU 2007/12/18  
 APPR AKANESHIGE 2007/12/18

FUNCTIONAL SYMBOLS $\nabla A = 0$ $\nabla B = 0$ $\nabla C = 0$ DIVISIONAL SYMBOLS	THIS DRAWING CONTAINS INFORMATION THAT IS PROPRIETARY TO MOLEX ELECTRONIC TECHNOLOGIES, LLC AND SHOULD NOT BE USED WITHOUT WRITTEN PERMISSION CURRENT REV DESC: For fixing wrong view of 6ckt		<b>molex</b>  2.0MM PITCH W/B CONN. WAFER ASSY R/A SMT					
	DIMENSION UNITS <b>mm</b>	SCALE <b>4:1</b>				PRODUCT SALES DRAWING		
	GENERAL TOLERANCES (UNLESS SPECIFIED) ANGULAR TOL $\pm 0.5^\circ$ 4 PLACES $\pm$ 3 PLACES $\pm$ 2 PLACES $\pm$ 1 PLACE $\pm$ 0 PLACES $\pm$		STATUS: Production DRWN: Hideo Yoneyama CHK'D: Hiromichi Komatsu APPR: Takashi Iida	2024-05-14 2024-05-16 2024-05-16	DOCUMENT NUMBER <b>SD-502352-001</b>	DOC TYPE <b>PSD</b>	DOC PART <b>001</b>	REVISION <b>L4</b>
	DRAFT WHERE APPLICABLE MUST REMAIN WITHIN DIMENSIONS		THIRD ANGLE PROJECTION 	DRAWING <b>A3-SIZE</b>	SERIES <b>502352</b>	MATERIAL NUMBER SEE CHART	CUSTOMER GENERAL MARKET	SHEET NUMBER 2 OF 4

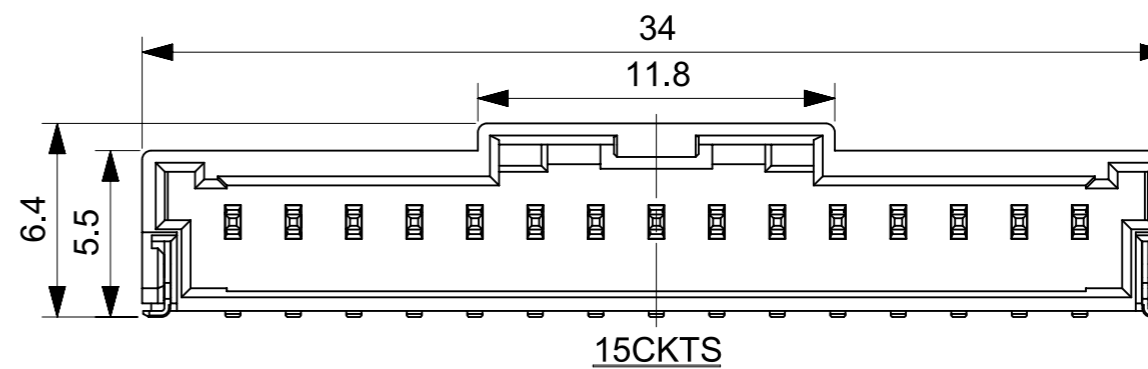
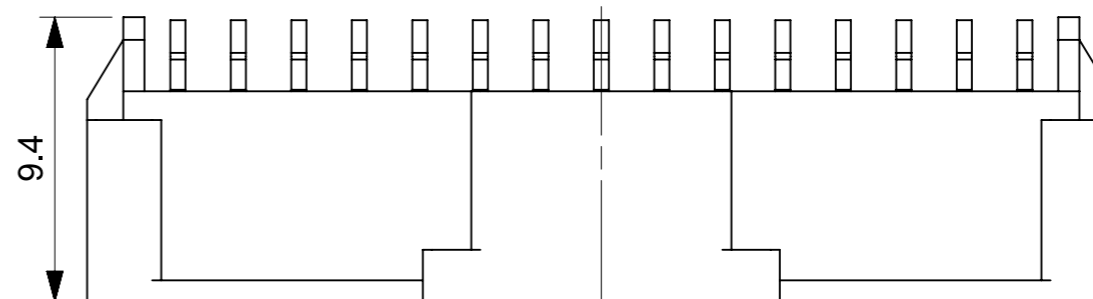
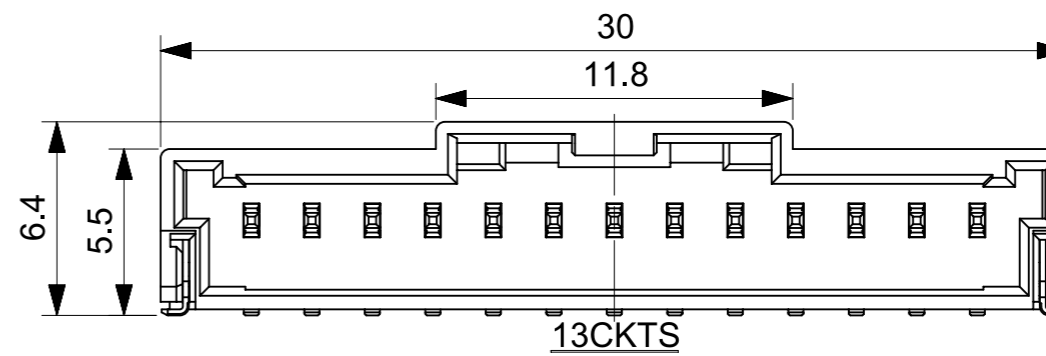
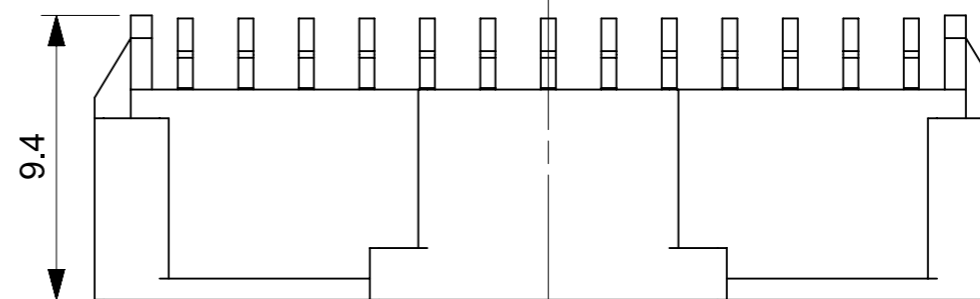
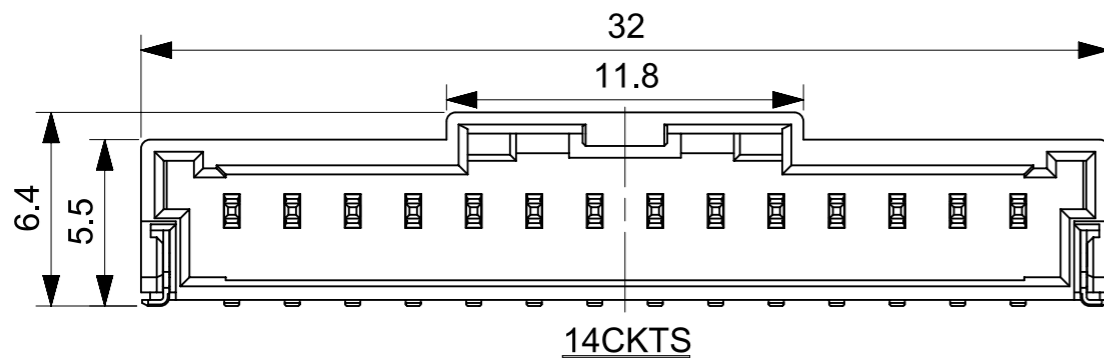
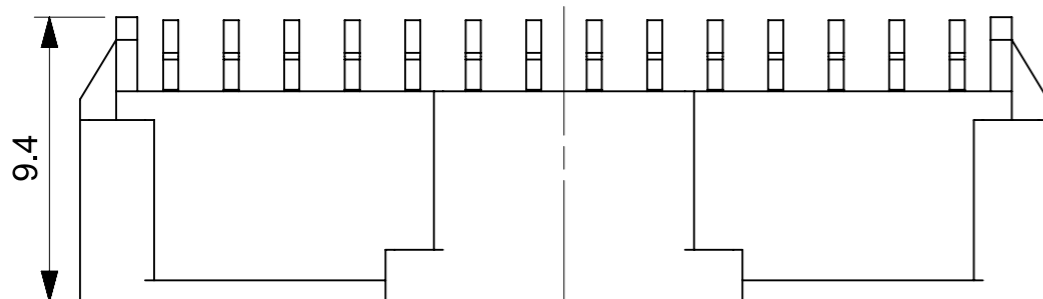
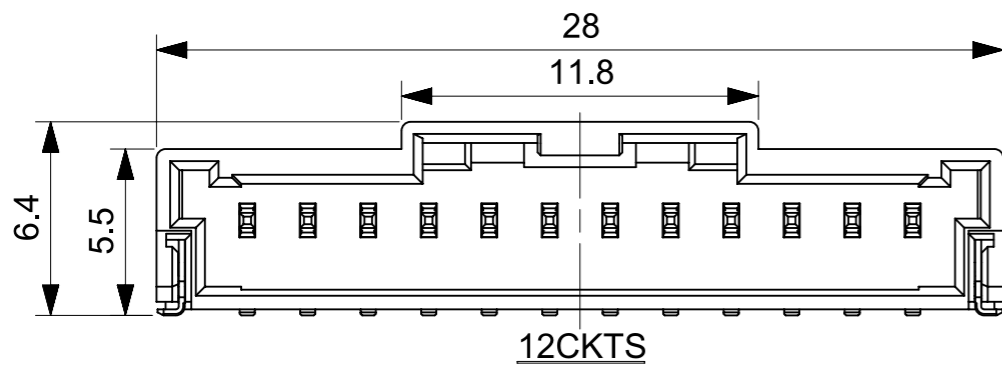
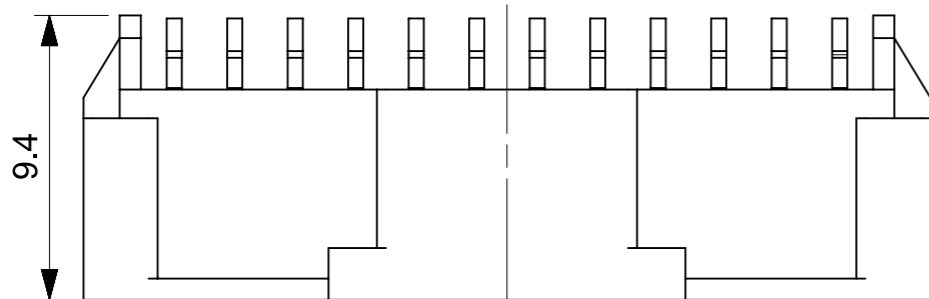

INITIAL REVISION:  
 DRWN SHSHIBATA 2007/12/18  
 CHECK HKOMATSU 2007/12/18  
 APPR AKANESHIGE 2007/12/18

FUNCTIONAL SYMBOLS $\nabla/A = 0$ $\nabla/B = 0$ $\nabla/C = 0$ DIVISIONAL SYMBOLS	THIS DRAWING CONTAINS INFORMATION THAT IS PROPRIETARY TO MOLEX ELECTRONIC TECHNOLOGIES, LLC AND SHOULD NOT BE USED WITHOUT WRITTEN PERMISSION CURRENT REV DESC: For fixing wrong view of 6ckt		<b>molex</b> 2.0MM PITCH W/B CONN. WAFER ASSY R/A SMT				
	DIMENSION UNITS <b>mm</b>	SCALE <b>4:1</b>				PRODUCT SALES DRAWING	
	GENERAL TOLERANCES (UNLESS SPECIFIED) ANGULAR TOL $\pm 0.5^\circ$ 4 PLACES $\pm$ 3 PLACES $\pm$ 2 PLACES $\pm$ 1 PLACE $\pm$ 0 PLACES $\pm$		STATUS: Production DRWN: Hideo Yoneyama 2024-05-14 CHK'D: Hiromichi Komatsu 2024-05-16 APPR: Takashi Iida 2024-05-16	DOCUMENT NUMBER <b>SD-502352-001</b>	DOC TYPE <b>PSD</b>	DOC PART <b>001</b>	REVISION <b>L4</b>
	DRAFT WHERE APPLICABLE MUST REMAIN WITHIN DIMENSIONS		THIRD ANGLE PROJECTION 	DRAWING <b>A3-SIZE</b>	SERIES <b>502352</b>	MATERIAL NUMBER <b>SEE CHART</b>	CUSTOMER <b>GENERAL MARKET</b>

Sn NATURAL	34.0	502352-1500	15
	32.0	502352-1400	14
	30.0	502352-1300	13
	28.0	502352-1200	12
	26.0	502352-1100	11
	24.0	502352-1000	10
	22.0	502352-0900	9
	20.0	502352-0800	8
	18.0	502352-0700	7
	16.0	502352-0600	6
	14.0	502352-0500	5
	12.0	502352-0400	4
10.0	502352-0300	3	
8.0	502352-0200	2	
PLATING COLOR	A	EMBOSSSED PACKAGE ORDER NO.	CKTS
CONNECTOR SERIES NO. 502352-**08			

Au NATURAL	34.0	502352-1510	15
	32.0	502352-1410	14
	30.0	502352-1310	13
	28.0	502352-1210	12
	26.0	502352-1110	11
	24.0	502352-1010	10
	22.0	502352-0910	9
	20.0	502352-0810	8
	18.0	502352-0710	7
	16.0	502352-0610	6
	14.0	502352-0510	5
	12.0	502352-0410	4
10.0	502352-0310	3	
8.0	502352-0210	2	
PLATING COLOR	A	EMBOSSSED PACKAGE ORDER NO.	CKTS
CONNECTOR SERIES NO. 502352-**18			

Sn BLACK	34.0	502352-1501	15
	32.0	502352-1401	14
	30.0	502352-1301	13
	28.0	502352-1201	12
	26.0	502352-1101	11
	24.0	502352-1001	10
	22.0	502352-0901	9
	20.0	502352-0801	8
	18.0	502352-0701	7
	16.0	502352-0601	6
	14.0	502352-0501	5
	12.0	502352-0401	4
10.0	502352-0301	3	
8.0	502352-0201	2	
PLATING COLOR	A	EMBOSSSED PACKAGE ORDER NO.	CKTS
CONNECTOR SERIES NO. 502352-**28			

Sn RED	-	-	15
	-	-	14
	-	-	13
	-	-	12
	-	-	11
	-	-	10
	-	-	9
	20.0	502352-0802	8
	-	-	7
	16.0	502352-0602	6
	-	-	5
	12.0	502352-0402	4
10.0	502352-0302	3	
8.0	502352-0202	2	
PLATING COLOR	A	EMBOSSSED PACKAGE ORDER NO.	CKTS
CONNECTOR SERIES NO. 502352-**48			

Sn BLUE	-	-	15
	-	-	14
	-	-	13
	-	-	12
	-	-	11
	-	-	10
	-	-	9
	20.0	502352-0803	8
	-	-	7
	16.0	502352-0603	6
	-	-	5
	12.0	502352-0403	4
10.0	502352-0303	3	
8.0	502352-0203	2	
PLATING COLOR	A	EMBOSSSED PACKAGE ORDER NO.	CKTS
CONNECTOR SERIES NO. 502352-**68			

INITIAL REVISION:  
 DRWN SHSHIBATA 2007/12/18  
 CHECK HKOMATSU 2007/12/18  
 APPR AKANESHIGE 2007/12/18

FUNCTIONAL SYMBOLS				THIS DRAWING CONTAINS INFORMATION THAT IS PROPRIETARY TO MOLEX ELECTRONIC TECHNOLOGIES, LLC AND SHOULD NOT BE USED WITHOUT WRITTEN PERMISSION													
DIMENSION UNITS		SCALE		CURRENT REV DESC: For fixing wrong view of 6ckt													
mm		1:1															
GENERAL TOLERANCES (UNLESS SPECIFIED)																	
ANGULAR TOL ± 0.5°																	
4 PLACES ±																	
3 PLACES ±																	
2 PLACES ±																	
1 PLACE ±																	
0 PLACES ±																	
DRAFT WHERE APPLICABLE MUST REMAIN WITHIN DIMENSIONS				THIRD ANGLE PROJECTION		DRAWING		SERIES		MATERIAL NUMBER		CUSTOMER		SHEET NUMBER			
						A3-SIZE		502352		SEE CHART		GENERAL MARKET		4 OF 4			
				STATUS: Production													
				DRWN: Hideo Yoneyama				2024-05-14									
				CHK'D: Hiromichi Komatsu				2024-05-16									
				APPR: Takashi Iida				2024-05-16									
				DOCUMENT NUMBER				SD-502352-001				DOC TYPE		DOC PART		REVISION	
								PSD		001		L4					



2.0MM PITCH W/B CONN.  
 WAFER ASSY R/A SMT

PRODUCT SALES DRAWING

注記  
NOTES

- 製品番号  
 ナチュラル・錫めっき: 502352-\*\*00  
 ナチュラル・金めっき: 502352-\*\*10  
 黒・錫めっき: 502352-\*\*01  
 赤・錫めっき: 502352-\*\*02  
 青・錫めっき: 502352-\*\*03  
 詳細寸法については、製品単体図面を参照下さい。  
 PART NO.  
 NATURAL Sn Plating: 502352-\*\*00  
 NATURAL Au Plating: 502352-\*\*10  
 BLACK Sn Plating: 502352-\*\*01  
 RED Sn Plating: 502352-\*\*02  
 BLUE Sn Plating: 502352-\*\*03  
 SEE SALES DRAWING FOR CONNECTOR
- 梱包数量: 700個/リール  
 NUMBER OF CONNECTORS 700PCS/REEL
- リードテープ長さ  
 LEAD TAPE LENGHT
- 材料  
 MATERIAL  
 キャリアテープ: ポリスチレン  
 CARRIER TAPE: POLYSTYRENE  
 トップテープ: PET, PE, PEF  
 TOP TAPE: PET, PE, PEF  
 リール: ポリスチレン  
 REEL: POLYSTYRENE
- 一般公差  
 GENERAL TOLERANCES  
 10 UNDER:  $\pm 0.2$   
 10 OVER 30 UNDER:  $\pm 0.25$   
 30 OVER:  $\pm 0.3$   
 ANGULAR:  $\pm 1^\circ$

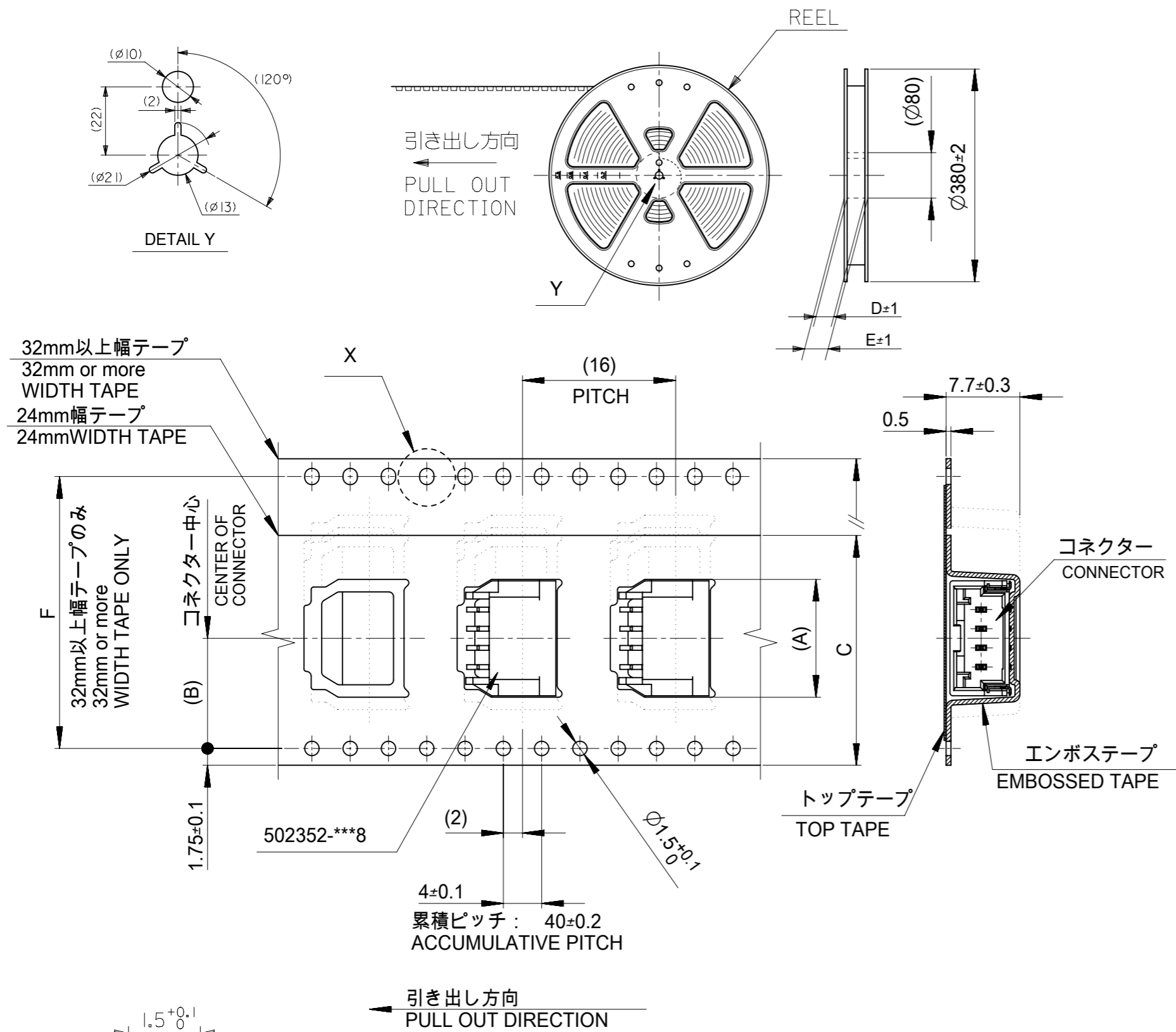
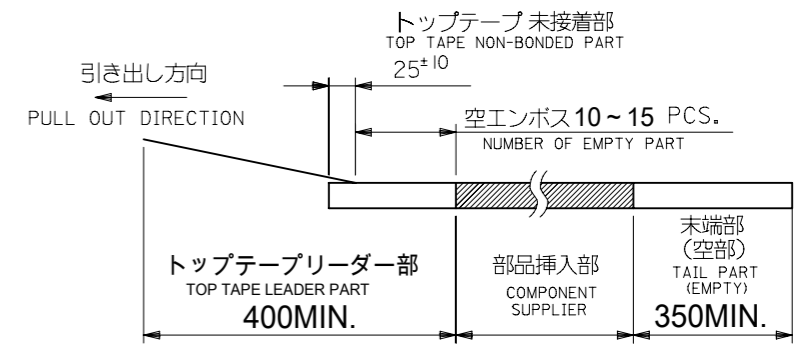

引き出し方向  
PULL OUT DIRECTION

エンボステープ内の製品の向き  
DIRECTION OF CONNECTOR  
IN EMBOSSED TAPE

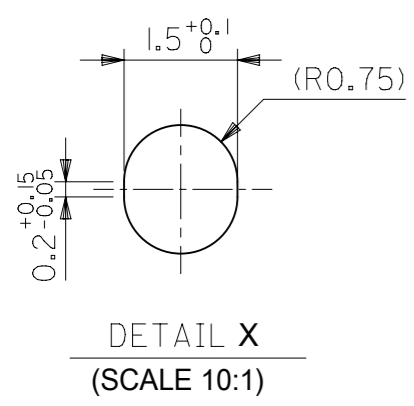

THIS DRAWING CONTAINS INFORMATION THAT IS PROPRIETARY TO MOLEX ELECTRONIC TECHNOLOGIES, LLC AND SHOULD NOT BE USED WITHOUT WRITTEN PERMISSION		CURRENT REV DESC:		<b>molex</b>	
DIMENSION UNITS	SCALE				
mm	NTS			2.0MM PITCH W/B CONN. WAFER ASSY EMBOSSED TAPE PACKAGE	
GENERAL TOLERANCES (UNLESS SPECIFIED)		EC NO: 629663		PRODUCT CUSTOMER DRAWING	
ANGULAR TOL	±	DRWN: MSATO08	2019/12/26	DOCUMENT NUMBER	
4 PLACES	±	CHK'D: HIJIMA	2019/12/27	SD-502352-002	
3 PLACES	±	APPR: TOSADA	2019/12/27	DOC TYPE	DOC PART
2 PLACES	±	INITIAL REVISION:		PSD	001
1 PLACE	±	DRWN: SHSHIBATA	2007/06/19	REVISION	
0 PLACES	±	APPR: AKANESHIGE	2007/06/19	K2	
DRAFT WHERE APPLICABLE MUST REMAIN WITHIN DIMENSIONS		THIRD ANGLE PROJECTION	DRAWING	SERIES	MATERIAL NUMBER
			A3-SIZE	502352	CUSTOMER
					GENERAL MARKET
					SHEET NUMBER
					1 OF 2

INITIAL REVISION:

DRWN	SHSHIBATA	2007/06/06
CHECK	TAITO	2007/06/06
APPR	MAYAMAMOTO	2012/03/14

E	Sn NATURAL	52.4	61.4	57.4	56	26.2	34.3	502352-1500	15	Au NATURAL	52.4	61.4	57.4	56	26.2	34.3	502352-1510	15	D	PLATING COLOR	F	E	D	C	(B)	(A)	エンボス梱包品 製品番号 EMBOSSED PACKAGE MATERIAL NO.	極数 CKT.	3	2																								
							32.3	502352-1400	14							32.3	502352-1410	14																																				
		40.4	49.4	45.4	44	20.2	30.3	502352-1300	13		40.4	49.4	45.4	44	20.2	30.3	502352-1310	13																		28.3	502352-1200	12						28.3	502352-1210	12								
							26.3	502352-1100	11							26.3	502352-1110	11																		24.3	502352-1000	10						24.3	502352-1010	10								
							22.3	502352-0900	9							22.3	502352-0910	9																		20.3	502352-0800	8						20.3	502352-0810	8								
		28.4	37.4	33.4	32	14.2	18.3	502352-0700	7		28.4	37.4	33.4	32	14.2	18.3	502352-0710	7																		16.3	502352-0600	6						16.3	502352-0610	6								
							14.3	502352-0500	5							14.3	502352-0510	5																		14.3	502352-0500	5						12.3	502352-0400	4						12.3	502352-0410	4
			29.4	25.4	24	11.5	12.3	502352-0400	4							10.3	502352-0300	3																		10.3	502352-0310	3						10.3	502352-0310	3								
							8.3	502352-0200	2							8.3	502352-0210	2																		8.3	502352-0210	2																

C	Sn BLACK	52.4	61.4	57.4	56	26.2	34.3	502352-1501	15	Sn RED											Sn BLUE											B	PLATING COLOR	F	E	D	C	(B)	(A)	エンボス梱包品 製品番号 EMBOSSED PACKAGE MATERIAL NO.	極数 CKT.	3	2																										
							32.3	502352-1401	14																		20.3	502352-0802	8																		20.3	502352-0803	8																				
		40.4	49.4	45.4	44	20.2	30.3	502352-1301	13																																													16.3	502352-0602	6						16.3	502352-0603	6					
							28.3	502352-1201	12																																																		12.3	502352-0402	4						12.3	502352-0403	4
							26.3	502352-1101	11																																													10.3	502352-0302	3						10.3	502352-0303	3					
							24.3	502352-1001	10																																													8.3	502352-0202	2						8.3	502352-0203	2					
							22.3	502352-0901	9																																																												
		28.4	37.4	33.4	32	14.2	20.3	502352-0801	8		28.4	37.4	33.4	32	14.2																																																						
							18.3	502352-0701	7																																																												
							16.3	502352-0601	6																																																												
							14.3	502352-0501	5																																																												
			29.4	25.4	24	11.5	12.3	502352-0401	4																																																												
							10.3	502352-0301	3																																																												
							8.3	502352-0201	2																																																												

THIS DRAWING CONTAINS INFORMATION THAT IS PROPRIETARY TO MOLEX ELECTRONIC TECHNOLOGIES, LLC AND SHOULD NOT BE USED WITHOUT WRITTEN PERMISSION																			
DIMENSION UNITS: mm SCALE: NTS		CURRENT REV DESC:																	
GENERAL TOLERANCES (UNLESS SPECIFIED)		EC NO: 629663 DRWN: MSATO08 2019/12/26 CHK'D: HIJIMA 2019/12/27 APPR: TOSADA 2019/12/27				2.0MM PITCH W/B CONN. WAFER ASSY EMBOSSED TAPE PACKAGE													
ANGULAR TOL ± °		INITIAL REVISION:				PRODUCT CUSTOMER DRAWING													
4 PLACES ±		DRWN: SHSHIBATA 2007/06/19 APPR: AKANESHIGE 2007/06/19				DOCUMENT NUMBER: SD-502352-002		DOC TYPE: PSD	DOC PART: 001	REVISION: K2									
3 PLACES ±		DRAFT WHERE APPLICABLE MUST REMAIN WITHIN DIMENSIONS		THIRD ANGLE PROJECTION	DRAWING: A3-SIZE	SERIES: 502352	MATERIAL NUMBER: SEE CHART	CUSTOMER: GENERAL MARKET		SHEET NUMBER: 2 OF 2									
2 PLACES ±		INITIAL REVISION:		DRWN: SHSHIBATA 2007/06/06	CHECK TAITO 2007/06/06	APPR: MAYAMAMOTO 2012/03/14													
1 PLACE ±		DOCUMENT STATUS: P1		RELEASE DATE: 2019/12/27 08:05:27															
0 PLACES ±		9		8		7		6		5		4		3		2		1	