

171692-0110

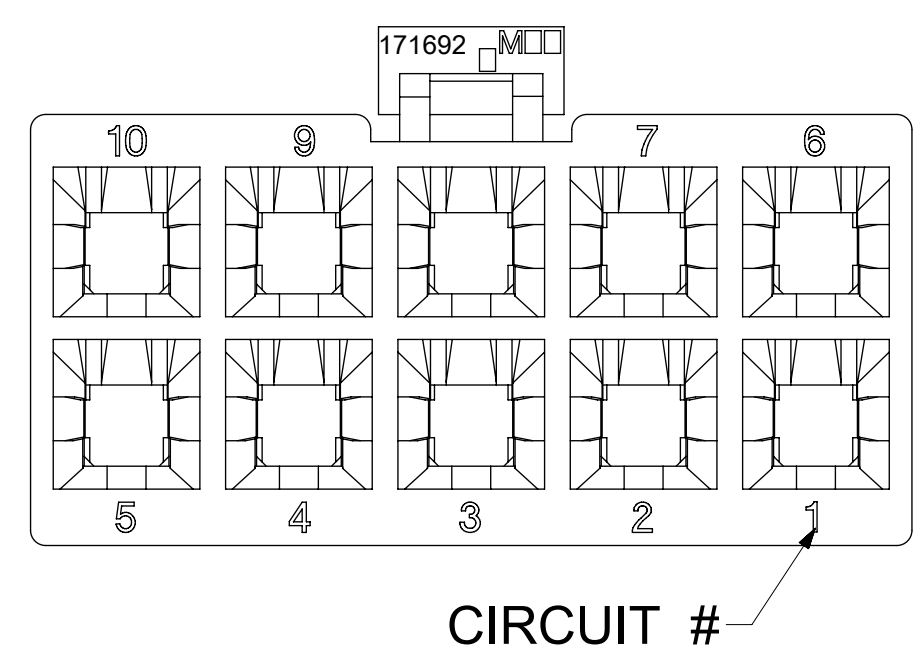
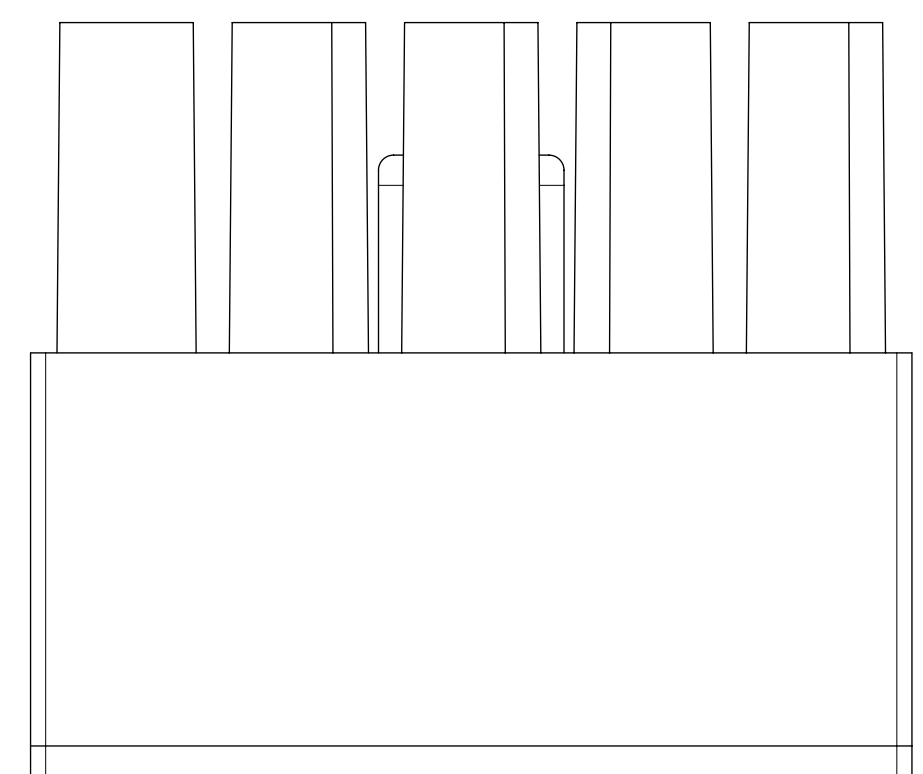
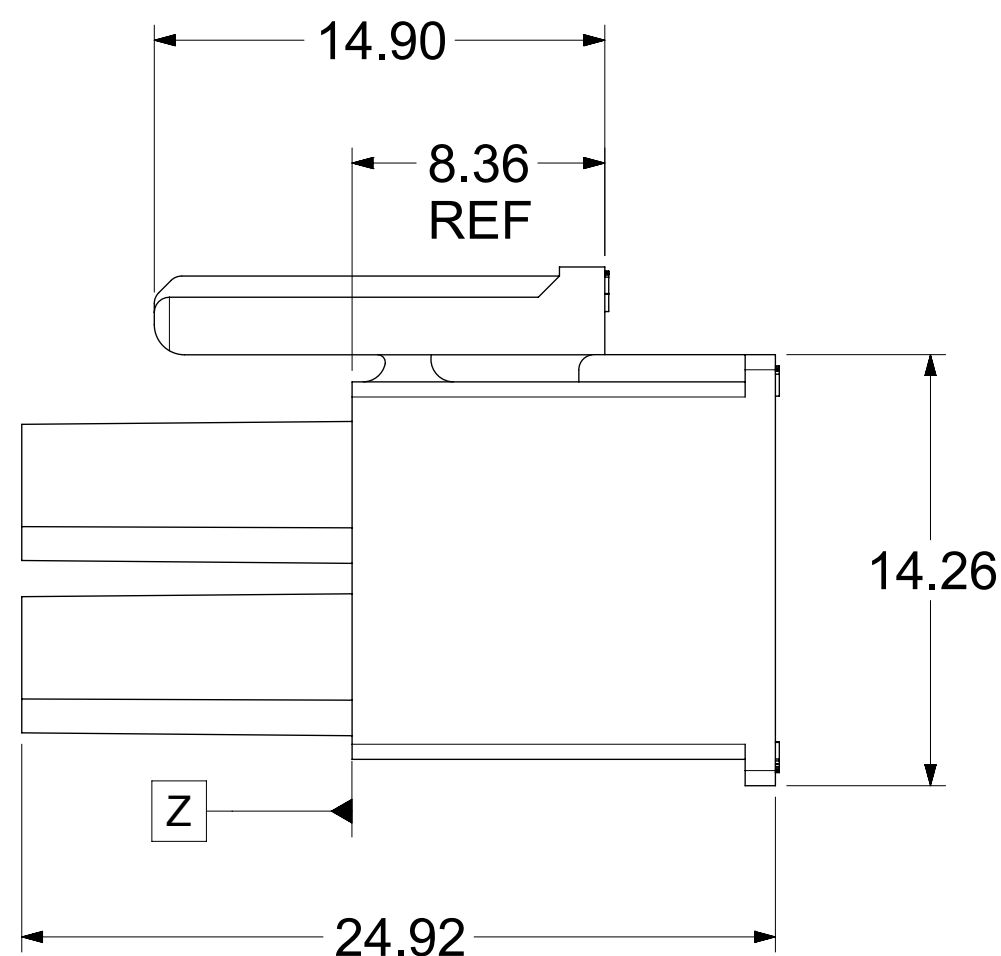
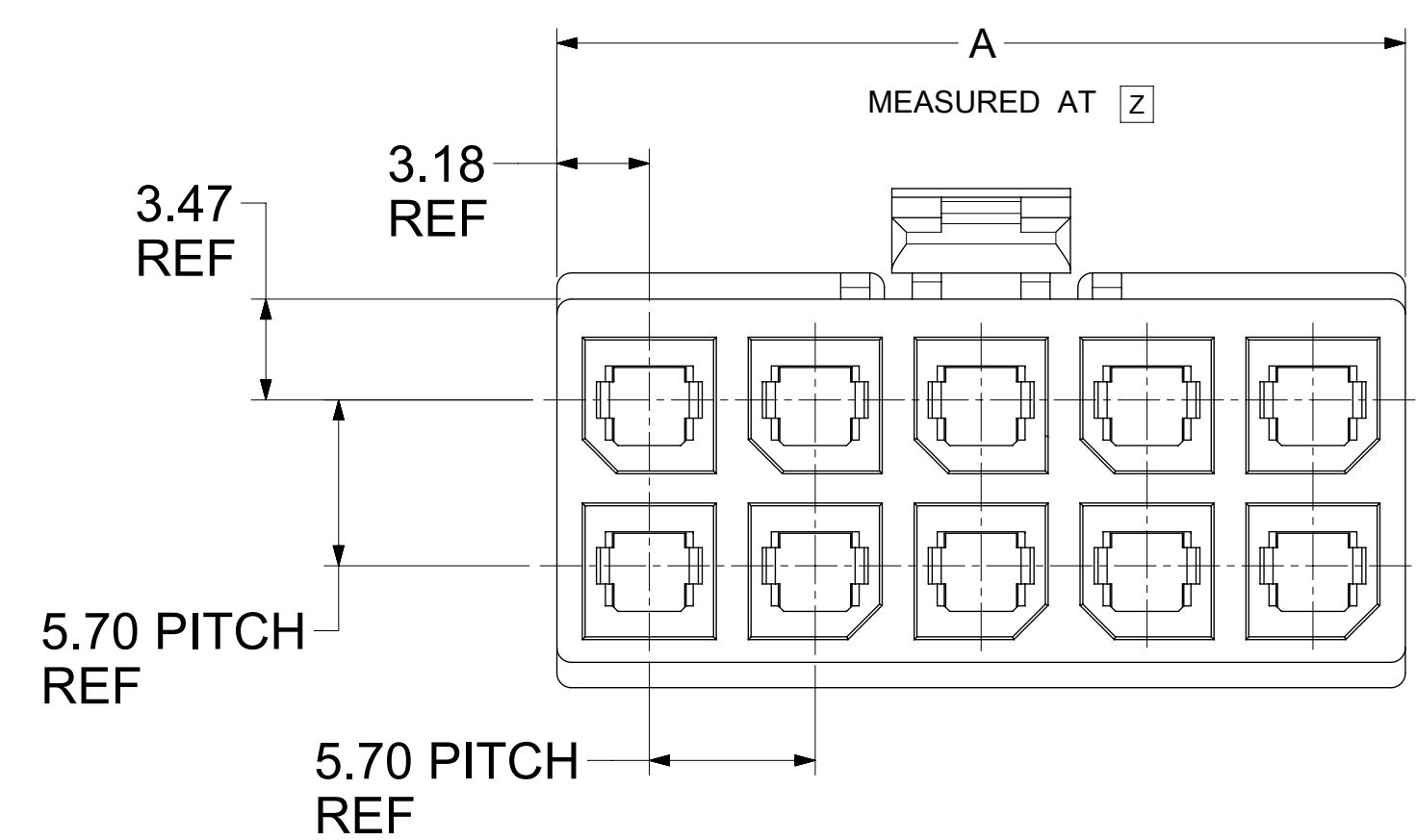

CKT NO	PART NO	DIM A
2	171692-0102	8.35
4	171692-0104	12.05
6	171692-0106	17.75
8	171692-0108	23.45±0.40
10	171692-0110	29.15±0.40
12	171692-0112	34.85±0.40

NOTES:

- MATERIAL:
HOUSING: PBT, UL 94V-0, COLOR: BLACK.
- FINISH: NOT APPLICABLE.
- PRODUCT SPECIFICATION: PS-76823-100.
- PACKAGING: BULK PACK PER PK-170001-001
- PART MATES WITH MOLEX SERIES NUMBERS 76825, 76829, 172064, AND 172065.
- PART IS FOR USE WITH MOLEX FEMALE TERMINAL 76823-032X OR 172063-031X OR 172063-131X SERIES.
- APPLICATION SPECIFICATION: AS-76823-100.

THIS DRAWING CONTAINS INFORMATION THAT IS PROPRIETARY TO MOLEX ELECTRONIC TECHNOLOGIES, LLC AND SHOULD NOT BE USED WITHOUT WRITTEN PERMISSION		CURRENT REV DESC:			
DIMENSION UNITS	SCALE				
mm	NTS			MEGA-FIT RECEPTACLE HOUSING 2-12 CKT	
GENERAL TOLERANCES (UNLESS SPECIFIED)		EC NO: 755658		DOCUMENT NUMBER	
ANGULAR TOL	± 0.5°	DRWN: WYATTH5 2023/07/04		SD-171692-0100	
4 PLACES	±	CHK'D: XQZHANG 2023/07/24		DOC TYPE	DOC PART
3 PLACES	±	APPR: XQZHANG 2023/07/24		PSD	001
2 PLACES	± 0.25	INITIAL REVISION:		REVISION	
1 PLACE	±	DRWN: MKARADIMAS 2012/08/01		C2	
0 PLACES	±	APPR: APATEL 2012/08/17			
DRAFT WHERE APPLICABLE MUST REMAIN WITHIN DIMENSIONS		THIRD ANGLE PROJECTION	DRAWING	SERIES	MATERIAL NUMBER
			D-SIZE	171692	SEE CHART
					CUSTOMER
					GENERAL MARKET
					SHEET NUMBER
					1 OF 2

2 CKTS

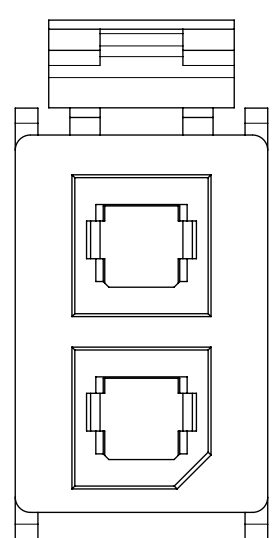

4 CKT

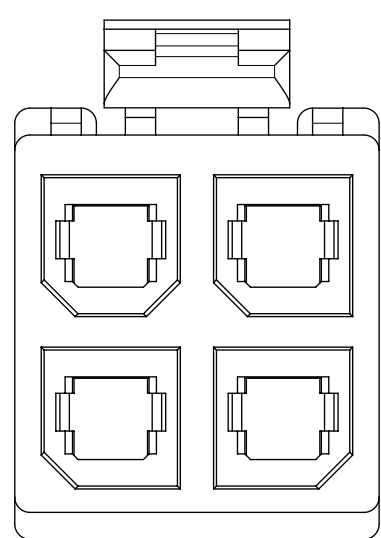

6 CKT

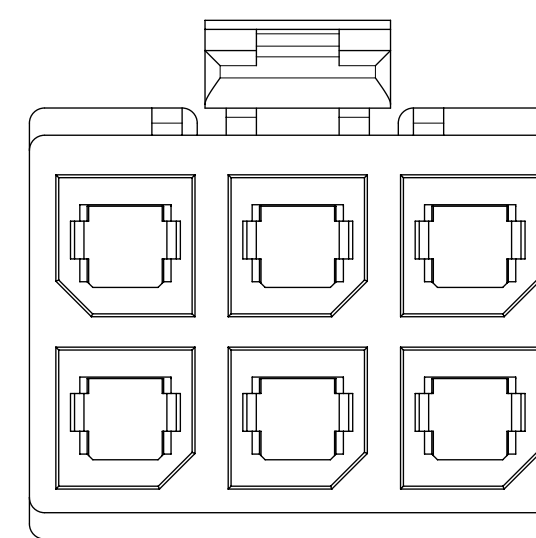

8 CKT

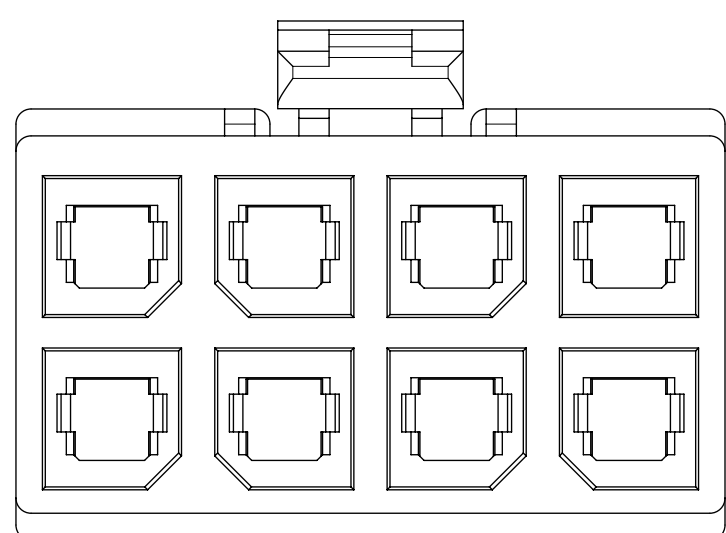

10 CKTS

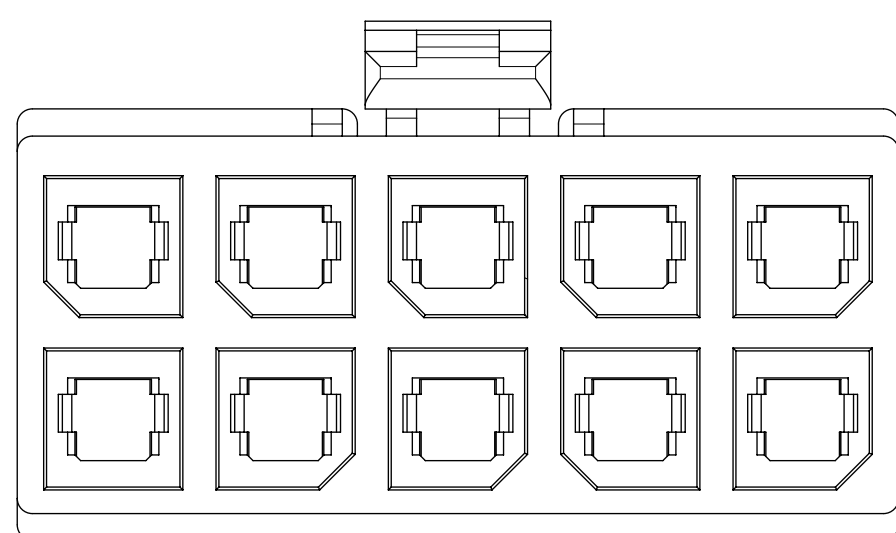

12 CKTS

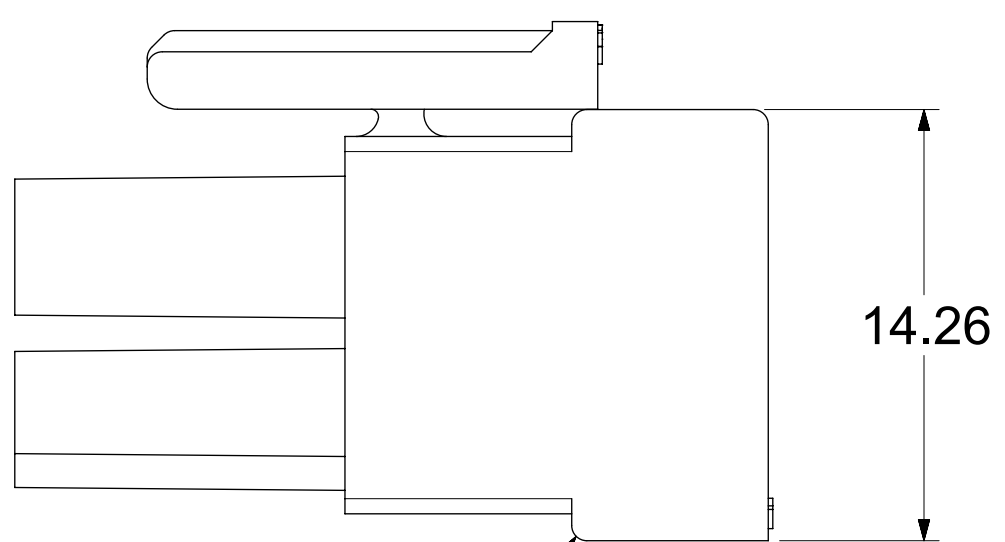
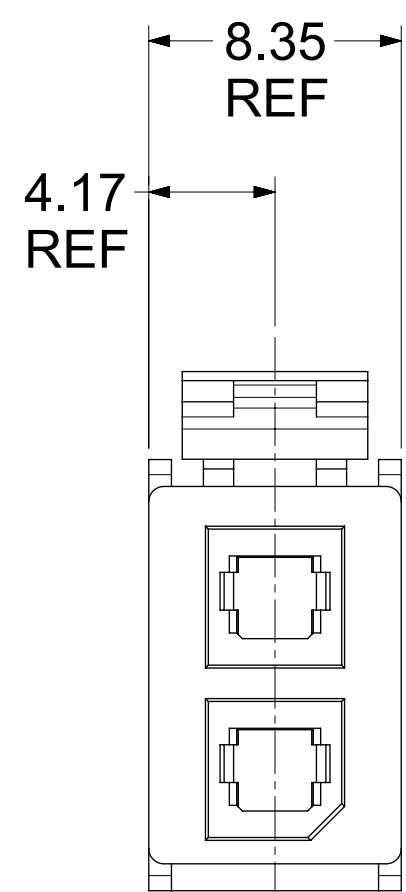
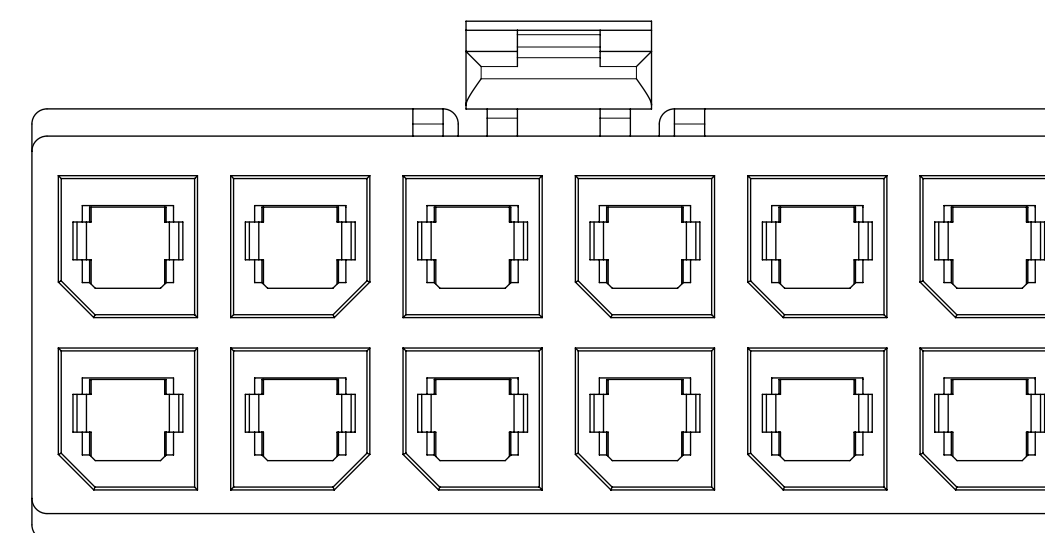

BOTTOM RIB ON
2 CKT ONLY

171692-0102

THIS DRAWING CONTAINS INFORMATION THAT IS PROPRIETARY TO MOLEX ELECTRONIC TECHNOLOGIES, LLC AND SHOULD NOT BE USED WITHOUT WRITTEN PERMISSION											
DIMENSION UNITS		SCALE		CURRENT REV DESC:						molex	
mm		NTS									
GENERAL TOLERANCES (UNLESS SPECIFIED)				EC NO: 755658						MEGA-FIT RECEPTACLE HOUSING 2-12 CKT	
ANGULAR TOL ± 0.5°				DRWN: WYATTH5 2023/07/04						PRODUCT CUSTOMER DRAWING	
4 PLACES ±				CHK'D: XQZHANG 2023/07/24						DOCUMENT NUMBER	
3 PLACES ±				APPR: XQZHANG 2023/07/24						DOC TYPE	
2 PLACES ± 0.25				INITIAL REVISION:						DOC PART	
1 PLACE ±				DRWN: MKARADIMAS 2012/08/01						REVISION	
0 PLACES ±				APPR: APATEL 2012/08/17						SD-171692-0100	
DRAFT WHERE APPLICABLE MUST REMAIN WITHIN DIMENSIONS				THIRD ANGLE PROJECTION		DRAWING		SERIES		MATERIAL NUMBER	
						D-SIZE		171692		CUSTOMER	
						SEE CHART		GENERAL MARKET		SHEET NUMBER	
										2 OF 2	