

CKT	A	B
2	3.85	NA
4	6.85	3
6	9.85	6
8	12.85	9
10	15.85	12
12	18.85	15
14	21.85	18
16	24.85	21
18	27.85	24
20	30.85	27
22	33.85	30
24	36.85	33

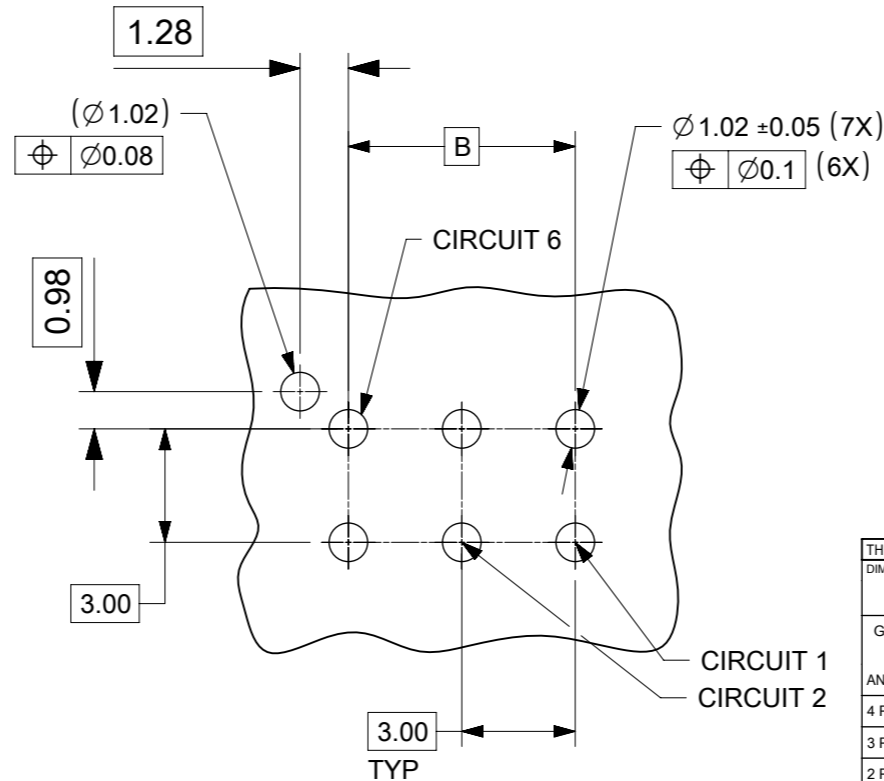
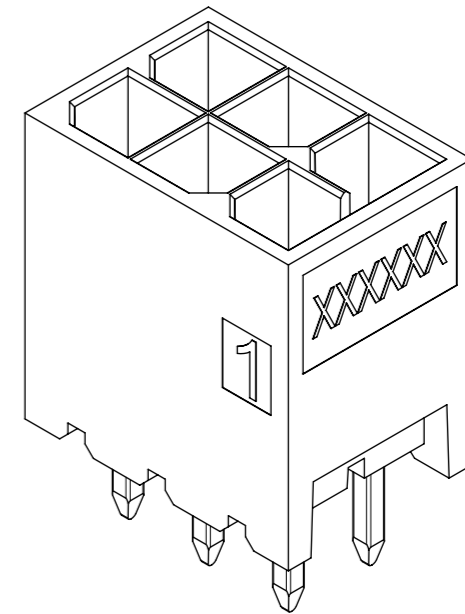
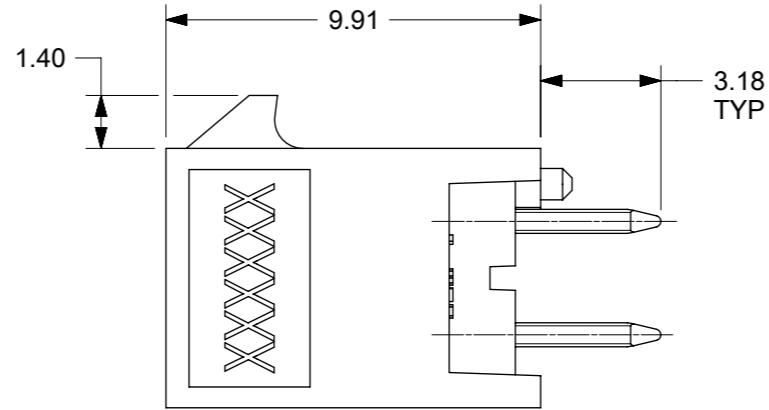
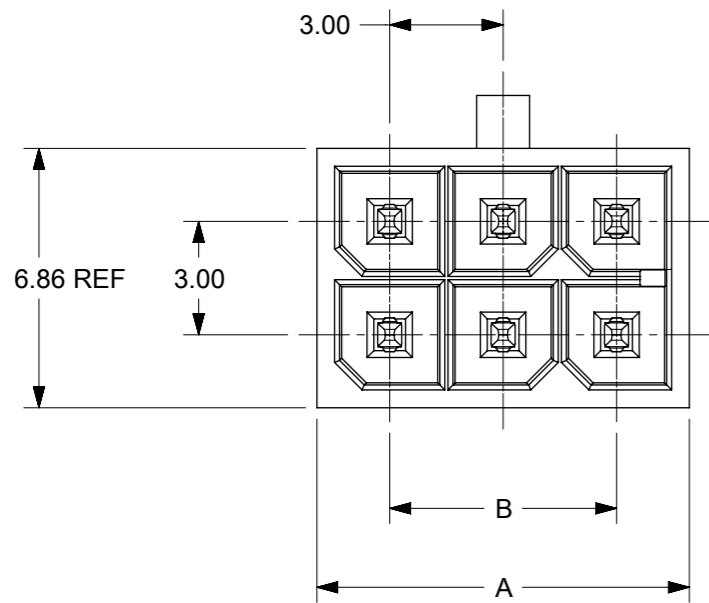
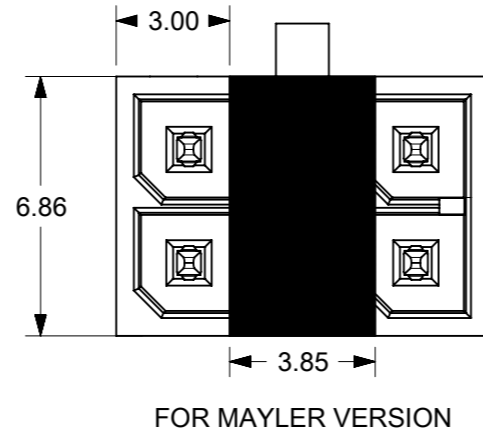
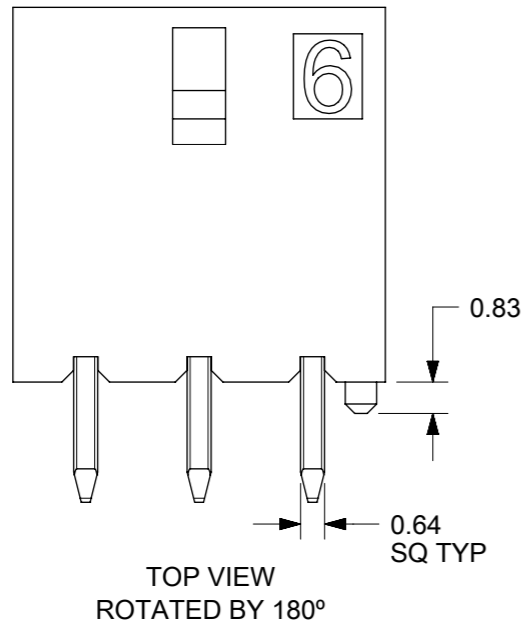

PCB LAYOUT: COMPONENT SIDE
RECOMENDED PCB THICKNESS: .062/1.57 Max.

NOTES:

- HOSING MATERIAL: GLASS FILLED LIQUID CRYSTAL POLYMER, UL 94V-0, COLOR: BLACK
TERMINAL MATERIAL: HIGH COPPER ALLOY
- FINISH:
OPTION 1: TIN OVER NICKEL OVERALL
OPTION 2: SELECT 15MICROINCH GOLD AND SELECT MATTE TIN OVER NICKEL.
OPTION 3: SELECT 30MICROINCH GOLD AND SELECT MATTE TIN OVER NICKEL.
- PRODUCT SPECIFICATION : 2064600000-PS
- TRAY PACK : 2068320000-PK
TAPE REEL PACK : 2068320001-PK
- MATE WITH RECEPTACLE 206461
- THIS PART CONFORMS TO CLASS 'B' REQUIREMENTS OF COSMETIC SPECIFICATION PS-45499-002.

DIMENSION UNITS		SCALE	CURRENT REV DESC:							
mm		5:1								
GENERAL TOLERANCES (UNLESS SPECIFIED)			<p>molex</p> <p>V HDR ASSY BANDO MICRO-FIT + SOLUTION</p> <p>PRODUCT CUSTOMER DRAWING</p>							
ANGULAR TOL $\pm 0.5^\circ$										
4 PLACES \pm										
3 PLACES \pm										
2 PLACES ± 0.25										
1 PLACE ± 0.36										
0 PLACES \pm			<p>INITIAL REVISION:</p> <p>DRWN: SMAHAJANSHET 2018/05/08</p> <p>APPR: NCSR 2019/04/02</p>							
DRAFT WHERE APPLICABLE MUST REMAIN WITHIN DIMENSIONS		THIRD ANGLE PROJECTION	DRAWING	SERIES	MATERIAL NUMBER	CUSTOMER	DOCUMENT NUMBER	DOC TYPE	DOC PART	REVISION
			A3-SIZE	206832	SEE TABLE	GENERAL MARKET	2068320000-SD	PSD	000	C
DOCUMENT STATUS		P1	RELEASE DATE	2023/08/24	11:19:05					

TIN PLATING				30 MICROINCH GOLD				15 MICROINCH GOLD				TIN PLATING				
TRAY PACKAGING -2068320000-PK				TRAY PACKAGING -2068320000-PK				TRAY PACKAGING -2068320000-PK				T&R PACKAGING -2068320001-PK				
CKT	VRT HDR ASSY PN	POLARIZATION	COLOR	CKT	VRT HDR ASSY PN	POLARIZATION	COLOR	CKT	VRT HDR ASSY PN	POLARIZATION	COLOR	CKT	VRT HDR ASSY PN	POLARIZATION	COLOR	
F	2068320201	A	BLACK	2	2068320203	A	BLACK	2	2068320202	A	BLACK	C	2	206832-0221	A	BLACK
	2242460210	B	NATURAL		2242460212	B	NATURAL		2242460211	B	NATURAL					
	2242460220	C	RED		2242460222	C	RED		2242460221	C	RED					
	2242460230	D	BLUE		2242460232	D	BLUE		2242460231	D	BLUE					
	2242460240	E	YELLOW		2242460242	E	YELLOW		2242460241	E	YELLOW					
4	2068320401	A	BLACK	4	2068320403	A	BLACK	4	2068320402	A	BLACK		4	206832-0421		
	2242460410	B	NATURAL		2242460412	B	NATURAL		2242460411	B	NATURAL		6	206832-0621		
	2242460420	C	RED		2242460422	C	RED		2242460421	C	RED		8	206832-0821		
	2242460430	D	BLUE		2242460432	D	BLUE		2242460431	D	BLUE		10	206832-1021		
	2242460440	E	YELLOW		2242460442	E	YELLOW		2242460441	E	YELLOW		12	206832-1221		
E	2068320601	A	BLACK	6	2068320603	A	BLACK	6	2068320602	A	BLACK		14	206832-1421		
	2242460610	B	NATURAL		2242460612	B	NATURAL		2242460611	B	NATURAL	16	206832-1621			
	2242460620	C	RED		2242460622	C	RED		2242460621	C	RED	18	206832-1821			
	2242460630	D	BLUE		2242460632	D	BLUE		2242460631	D	BLUE	20	206832-2021			
	2242460640	E	YELLOW		2242460642	E	YELLOW		2242460641	E	YELLOW	22	206832-2221			
8	2068320801	A	BLACK	8	2068320803	A	BLACK	8	2068320802	A	BLACK	24	206832-2421			
	2242460810	B	NATURAL		2242460812	B	NATURAL		2242460811	B	NATURAL	15 MICROINCH GOLD				
	2242460820	C	RED		2242460822	C	RED		2242460821	C	RED	T&R PACKAGING -2068320001-PK				
	2242460830	D	BLUE		2242460832	D	BLUE		2242460831	D	BLUE	CKT	VRT HDR ASSY PN	POLARIZATION	COLOR	
	2242460840	E	YELLOW		2242460842	E	YELLOW		2242460841	E	YELLOW	2	206832-0222	A	BLACK	
D	2068321001	A	BLACK	10	2068321003	A	BLACK	10	2068321002	A	BLACK	4	206832-0422			
	2242461010	B	NATURAL		2242461012	B	NATURAL		2242461011	B	NATURAL	6	206832-0622			
	2242461020	C	RED		2242461022	C	RED		2242461021	C	RED	8	206832-0822			
	2242461030	D	BLUE		2242461032	D	BLUE		2242461031	D	BLUE	10	206832-1022			
	2242461040	E	YELLOW		2242461042	E	YELLOW		2242461041	E	YELLOW	12	206832-1222			
12	2068321201	A	BLACK	12	2068321203	A	BLACK	12	2068321202	A	BLACK	14	206832-1422			
	2242461210	B	NATURAL		2242461212	B	NATURAL		2242461211	B	NATURAL	16	206832-1622			
	2242461220	C	RED		2242461222	C	RED		2242461221	C	RED	18	206832-1822			
	2242461230	D	BLUE		2242461232	D	BLUE		2242461231	D	BLUE	20	206832-2022			
	2242461240	E	YELLOW		2242461242	E	YELLOW		2242461241	E	YELLOW	22	206832-2222			
C	2068321401	A	BLACK	14	2068321403	A	BLACK	14	2068321402	A	BLACK	24	206832-2422			
	2068321601	A	BLACK		2068321603	A	BLACK		2068321602	A	BLACK	30 MICROINCH GOLD				
	2068321801	A	BLACK		2068321803	A	BLACK		2068321802	A	BLACK	T&R PACKAGING -2068320001-PK				
	2068322001	A	BLACK		2068322003	A	BLACK		2068322002	A	BLACK	CKT	VRT HDR ASSY PN	POLARIZATION	COLOR	
	2068322201	A	BLACK		2068322203	A	BLACK		2068322202	A	BLACK	2	206832-0223	A	BLACK	
206832-2401	A	BLACK	206832-2403	A	BLACK	206832-2402	A	BLACK	4	206832-0423						
											6	206832-0623				
											8	206832-0823				
											10	206832-1023				
											12	206832-1223				
											14	206832-1423				
											16	206832-1623				
											18	206832-1823				
											20	206832-2023				
											22	206832-2223				
											24	206832-2423				

THIS DRAWING CONTAINS INFORMATION THAT IS PROPRIETARY TO MOLEX ELECTRONIC TECHNOLOGIES, LLC AND SHOULD NOT BE USED WITHOUT WRITTEN PERMISSION																	
DIMENSION UNITS		SCALE		CURRENT REV DESC:						molex							
mm		1:1															
GENERAL TOLERANCES (UNLESS SPECIFIED)				EC NO: 760703 DRWN: VENKASS 2023/03/30 CHK'D: VENKASS 2023/08/24 APPR: MRAMAKRISHNA 2023/08/24 INITIAL REVISION: DRWN: SMAHAJANSHET 2018/05/08 APPR: NCSR 2019/04/02						V HDR ASSY BANDO MICRO-FIT + SOLUTION							
ANGULAR TOL ± 0.5°										PRODUCT CUSTOMER DRAWING							
4 PLACES ±										DOCUMENT NUMBER		DOC TYPE		DOC PART		REVISION	
3 PLACES ±										2068320000-SD		PSD		000		C	
2 PLACES ± 0.25										MATERIAL NUMBER		CUSTOMER		SHEET NUMBER			
1 PLACE ± 0.36				SEE TABLE		GENERAL MARKET		2 OF 4									
0 PLACES ±				THIRD ANGLE PROJECTION		DRAWING		SERIES									
DRAFT WHERE APPLICABLE MUST REMAIN WITHIN DIMENSIONS				A3-SIZE		206832											

9 8 7 6 5 4 3 2 1

CKT	POLARIZATION "A"- BLACK	POLARIZATION "B"- NATURAL	POLARIZATION "C" - RED	POLARIZATION "D" - BLUE	POLARIZATION "E" - YELLOW
2					
4					
6					
8					
10					
12					

Ⓒ

SYMBOLS DIMENSION UNITS: mm SCALE: 1:1 GENERAL TOLERANCES (UNLESS SPECIFIED) ANGULAR TOL ± 0.5° 4 PLACES ± 3 PLACES ± 2 PLACES ± 0.13 1 PLACE ± 0.25 0 PLACES ± DRAFT WHERE APPLICABLE MUST REMAIN WITHIN DIMENSIONS THIRD ANGLE PROJECTION DRAWING SERIES MATERIAL NUMBER CUSTOMER SHEET NUMBER	THIS DRAWING CONTAINS INFORMATION THAT IS PROPRIETARY TO MOLEX ELECTRONIC TECHNOLOGIES, LLC AND SHOULD NOT BE USED WITHOUT WRITTEN PERMISSION CURRENT REV DESC: EC NO: 760703 DRWN: VENKAS5 2023/03/30 CHK'D: VENKAS5 2023/08/24 APPR: MRAMAKRISHNA 2023/08/24 INITIAL REVISION: DRWN: SMAHAJANSHET 2018/05/08 APPR: NCSR 2019/04/02		 V HDR ASSY BANDO MICRO-FIT + SOLUTION	
	PRODUCT CUSTOMER DRAWING DOCUMENT NUMBER: 2068320000-SD DOC TYPE: PSD DOC PART: 000 REVISION: C		SEE TABLE GENERAL MARKET 3 OF 4	

9 8 7 6 5 4 3 2 1

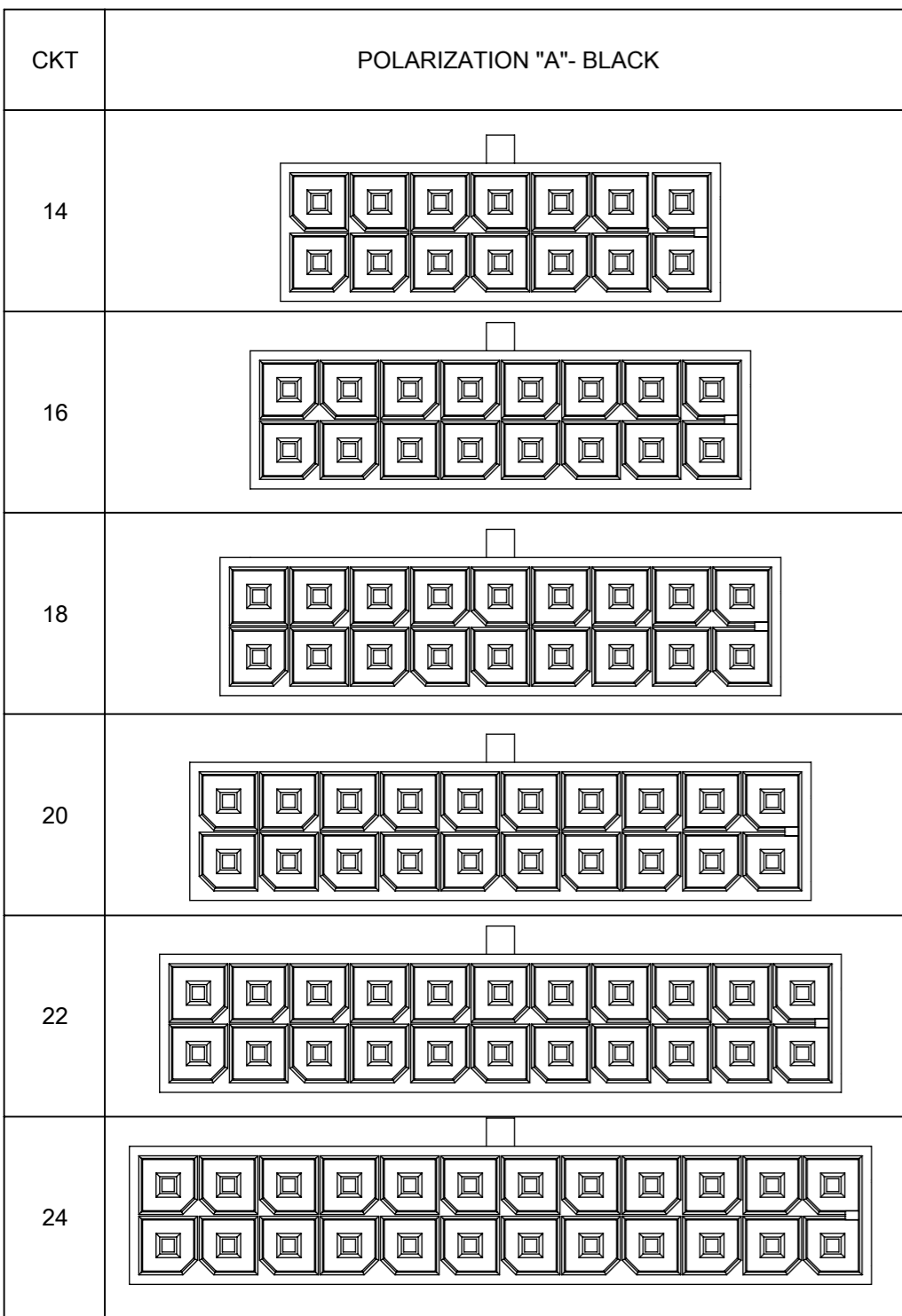

FUNCTIONAL SYMBOLS	THIS DRAWING CONTAINS INFORMATION THAT IS PROPRIETARY TO MOLEX ELECTRONIC TECHNOLOGIES, LLC AND SHOULD NOT BE USED WITHOUT WRITTEN PERMISSION		CURRENT REV DESC:					
	$\nabla_A = 0$ $\nabla_F = 0$ $\nabla_V = 0$	DIMENSION UNITS mm						
DIVISIONAL SYMBOLS	4 PLACES	\pm	EC NO: 760703	2023/03/30	V HDR ASSY BANDO MICRO-FIT + SOLUTION			
	3 PLACES	\pm	DRWN: VENKAS5	2023/08/24				
	2 PLACES	± 0.13	CHK'D: VENKAS5	2023/08/24	PRODUCT CUSTOMER DRAWING			
	1 PLACE	± 0.25	APPR: MRAMAKRISHNA	2023/08/24	DOCUMENT NUMBER	DOC TYPE	DOC PART	REVISION
	0 PLACES	\pm	INITIAL REVISION: DRWN: SMAHAJANSHET APPR: NCSR	2018/05/08 2019/04/02	2068320000-SD	PSD	000	C
DRAFT WHERE APPLICABLE MUST REMAIN WITHIN DIMENSIONS		THIRD ANGLE PROJECTION	DRAWING	SERIES	MATERIAL NUMBER	CUSTOMER	SHEET NUMBER	
			A3-SIZE	206832		GENERAL MARKET	4 OF 4	