

CKT	A	B
2	3.85	NA
4	6.85	3
6	9.85	6
8	12.85	9
10	15.85	12
12	18.85	15
14	21.85	18
16	24.85	21
18	27.85	24
20	30.85	27
22	33.85	30
24	36.85	33

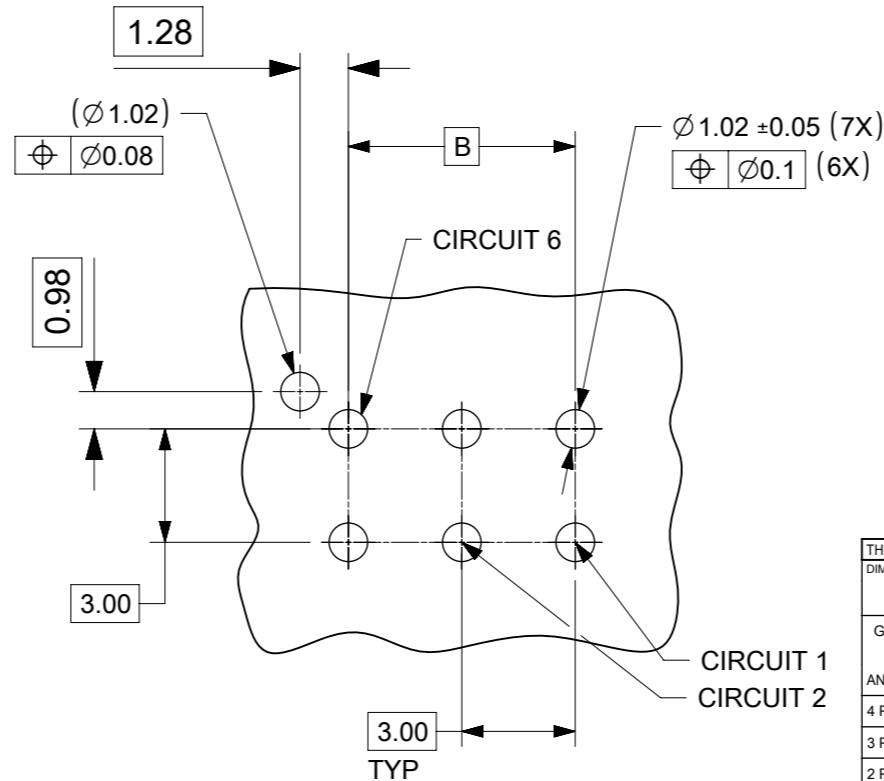
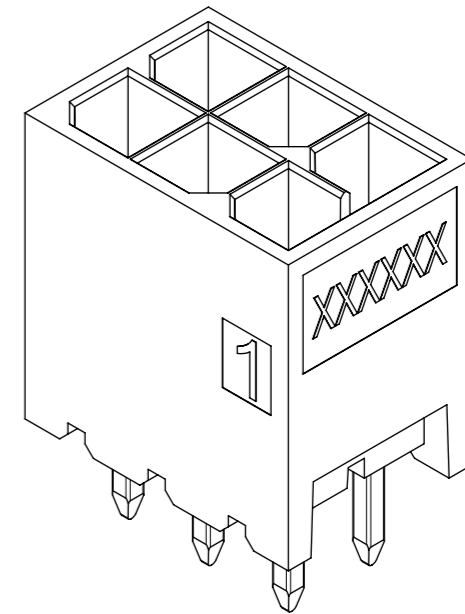
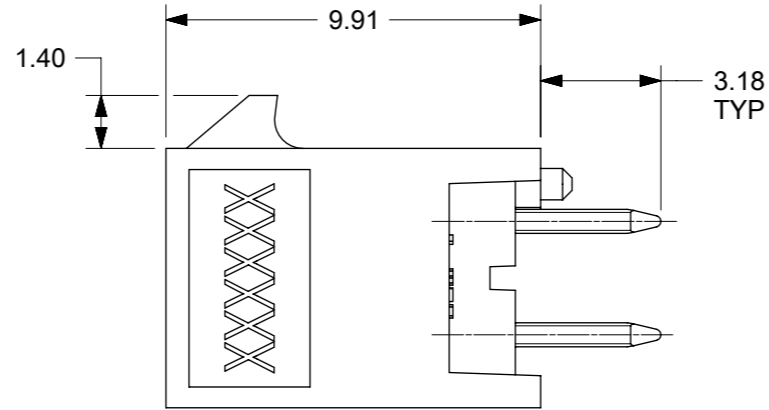
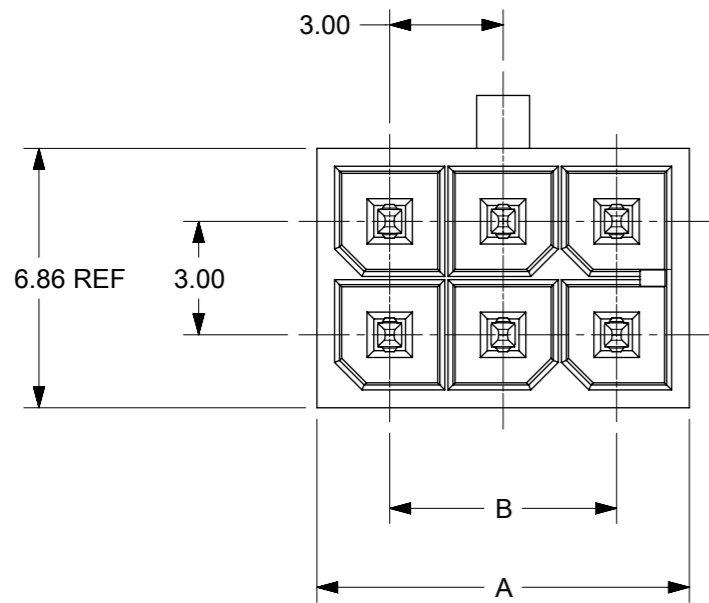
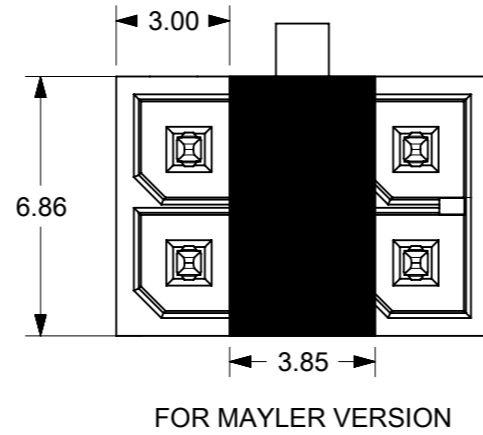
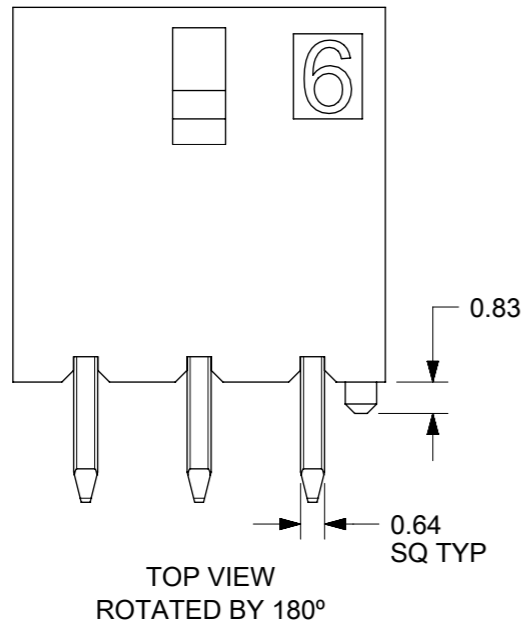

PCB LAYOUT: COMPONENT SIDE
RECOMENDED PCB THICKNESS: .062/1.57 Max.

NOTES:

- HOSING MATERIAL: GLASS FILLED LIQUID CRYSTAL POLYMER, UL 94V-0, COLOR: BLACK
TERMINAL MATERIAL: HIGH COPPER ALLOY
- FINISH:
OPTION 1: TIN OVER NICKEL OVERALL
OPTION 2: SELECT 15MICROINCH GOLD AND SELECT MATTE TIN OVER NICKEL.
OPTION 3: SELECT 30MICROINCH GOLD AND SELECT MATTE TIN OVER NICKEL.
- PRODUCT SPECIFICATION : 2064600000-PS
- TRAY PACK : 2068320000-PK
TAPE REEL PACK : 2068320001-PK
- MATE WITH RECEPTACLE 206461
- THIS PART CONFORMS TO CLASS 'B' REQUIREMENTS OF COSMETIC SPECIFICATION PS-45499-002.

DIMENSION UNITS		SCALE	CURRENT REV DESC:		
mm		5:1	EC NO: 760703		
GENERAL TOLERANCES (UNLESS SPECIFIED)			DRWN: VENKAS5 2023/03/30		
ANGULAR TOL \pm 0.5°			CHK'D: VENKAS5 2023/08/24		
4 PLACES \pm			APPR: MRAMAKRISHNA 2023/08/24		
3 PLACES \pm			INITIAL REVISION:		
2 PLACES \pm 0.25			DRWN: SMAHAJANSHET 2018/05/08		
1 PLACE \pm 0.36			APPR: NCSR 2019/04/02		
0 PLACES \pm			DOCUMENT NUMBER		
DRAFT WHERE APPLICABLE MUST REMAIN WITHIN DIMENSIONS			2068320000-SD		
THIRD ANGLE PROJECTION		DRAWING	SERIES	MATERIAL NUMBER	CUSTOMER
		A3-SIZE	206832	SEE TABLE	GENERAL MARKET
V HDR ASSY BANDO MICRO-FIT + SOLUTION			DOC TYPE	DOC PART	REVISION
PRODUCT CUSTOMER DRAWING			PSD	000	C
SHEET NUMBER					
1 OF 4					

TIN PLATING				30 MICROINCH GOLD				15 MICROINCH GOLD				TIN PLATING						
TRAY PACKAGING -2068320000-PK				TRAY PACKAGING -2068320000-PK				TRAY PACKAGING -2068320000-PK				T&R PACKAGING -2068320001-PK						
CKT	VRT HDR ASSY PN	POLARIZATION	COLOR	CKT	VRT HDR ASSY PN	POLARIZATION	COLOR	CKT	VRT HDR ASSY PN	POLARIZATION	COLOR	CKT	VRT HDR ASSY PN	POLARIZATION	COLOR			
F	2068320201	A	BLACK	2	2068320203	A	BLACK	2	2068320202	A	BLACK	C	C	A	BLACK			
	2242460210	B	NATURAL		2242460212	B	NATURAL		2242460211	B	NATURAL							
	2242460220	C	RED		2242460222	C	RED		2242460221	C	RED							
	2242460230	D	BLUE		2242460232	D	BLUE		2242460231	D	BLUE							
	2242460240	E	YELLOW		2242460242	E	YELLOW		2242460241	E	YELLOW							
4	2068320401	A	BLACK	4	2068320403	A	BLACK	4	2068320402	A	BLACK							
	2242460410	B	NATURAL		2242460412	B	NATURAL		2242460411	B	NATURAL							
	2242460420	C	RED		2242460422	C	RED		2242460421	C	RED							
	2242460430	D	BLUE		2242460432	D	BLUE		2242460431	D	BLUE							
	2242460440	E	YELLOW		2242460442	E	YELLOW		2242460441	E	YELLOW							
E	2068320601	A	BLACK	6	2068320603	A	BLACK	6	2068320602	A	BLACK							
	2242460610	B	NATURAL		2242460612	B	NATURAL		2242460611	B	NATURAL							
	2242460620	C	RED		2242460622	C	RED		2242460621	C	RED							
	2242460630	D	BLUE		2242460632	D	BLUE		2242460631	D	BLUE							
	2242460640	E	YELLOW		2242460642	E	YELLOW		2242460641	E	YELLOW							
8	2068320801	A	BLACK	8	2068320803	A	BLACK	8	2068320802	A	BLACK							
	2242460810	B	NATURAL		2242460812	B	NATURAL		2242460811	B	NATURAL							
	2242460820	C	RED		2242460822	C	RED		2242460821	C	RED							
	2242460830	D	BLUE		2242460832	D	BLUE		2242460831	D	BLUE							
	2242460840	E	YELLOW		2242460842	E	YELLOW		2242460841	E	YELLOW							
D	2068321001	A	BLACK	10	2068321003	A	BLACK	10	2068321002	A	BLACK							
	2242461010	B	NATURAL		2242461012	B	NATURAL		2242461011	B	NATURAL							
	2242461020	C	RED		2242461022	C	RED		2242461021	C	RED							
	2242461030	D	BLUE		2242461032	D	BLUE		2242461031	D	BLUE							
	2242461040	E	YELLOW		2242461042	E	YELLOW		2242461041	E	YELLOW							
12	2068321201	A	BLACK	12	2068321203	A	BLACK	12	2068321202	A	BLACK							
	2242461210	B	NATURAL		2242461212	B	NATURAL		2242461211	B	NATURAL							
	2242461220	C	RED		2242461222	C	RED		2242461221	C	RED							
	2242461230	D	BLUE		2242461232	D	BLUE		2242461231	D	BLUE							
	2242461240	E	YELLOW		2242461242	E	YELLOW		2242461241	E	YELLOW							
14	2068321401	A	BLACK	14	2068321403	A	BLACK	14	2068321402	A	BLACK	D	A	BLACK				
16	2068321601	A	BLACK	16	2068321603	A	BLACK	16	2068321602	A	BLACK							
18	2068321801	A	BLACK	18	2068321803	A	BLACK	18	2068321802	A	BLACK							
20	2068322001	A	BLACK	20	2068322003	A	BLACK	20	2068322002	A	BLACK							
22	2068322201	A	BLACK	22	2068322203	A	BLACK	22	2068322202	A	BLACK							
24	206832-2401	A	BLACK	24	206832-2403	A	BLACK	24	206832-2402	A	BLACK							
15 MICROINCH GOLD				T&R PACKAGING -2068320001-PK				15 MICROINCH GOLD							T&R PACKAGING -2068320001-PK			
CKT	VRT HDR ASSY PN	POLARIZATION	COLOR	CKT	VRT HDR ASSY PN	POLARIZATION	COLOR	CKT	VRT HDR ASSY PN	POLARIZATION	COLOR				CKT	VRT HDR ASSY PN	POLARIZATION	COLOR
2	206832-0221			4	206832-0421			6	206832-0621						8	206832-0821		
10	206832-1021			12	206832-1221			14	206832-1421						16	206832-1621		
18	206832-1821			20	206832-2021			22	206832-2221						24	206832-2421		
15 MICROINCH GOLD				T&R PACKAGING -2068320001-PK				15 MICROINCH GOLD							T&R PACKAGING -2068320001-PK			
CKT	VRT HDR ASSY PN	POLARIZATION	COLOR	CKT	VRT HDR ASSY PN	POLARIZATION	COLOR	CKT	VRT HDR ASSY PN	POLARIZATION	COLOR	CKT	VRT HDR ASSY PN	POLARIZATION	COLOR			
2	206832-0222			4	206832-0422			6	206832-0622			8	206832-0822					
10	206832-1022			12	206832-1222			14	206832-1422			16	206832-1622					
18	206832-1822			20	206832-2022			22	206832-2222			24	206832-2422					
30 MICROINCH GOLD				T&R PACKAGING -2068320001-PK				30 MICROINCH GOLD				T&R PACKAGING -2068320001-PK						
CKT	VRT HDR ASSY PN	POLARIZATION	COLOR	CKT	VRT HDR ASSY PN	POLARIZATION	COLOR	CKT	VRT HDR ASSY PN	POLARIZATION	COLOR	CKT	VRT HDR ASSY PN	POLARIZATION	COLOR			
2	206832-0223			4	206832-0423			6	206832-0623			8	206832-0823					
10	206832-1023			12	206832-1223			14	206832-1423			16	206832-1623					
18	206832-1823			20	206832-2023			22	206832-2223			24	206832-2423					

THIS DRAWING CONTAINS INFORMATION THAT IS PROPRIETARY TO MOLEX ELECTRONIC TECHNOLOGIES, LLC AND SHOULD NOT BE USED WITHOUT WRITTEN PERMISSION											
DIMENSION UNITS		SCALE		CURRENT REV DESC:							
mm		1:1		<p style="text-align: center;">molex</p> <p style="text-align: center;">V HDR ASSY BANDO MICRO-FIT + SOLUTION</p> <p style="text-align: center;">PRODUCT CUSTOMER DRAWING</p>							
GENERAL TOLERANCES (UNLESS SPECIFIED)											
ANGULAR TOL ± 0.5°											
4 PLACES ±		EC NO: 760703									
3 PLACES ±		DRWN: VENKASS 2023/03/30									
2 PLACES ± 0.25		CHK'D: VENKASS 2023/08/24									
1 PLACE ± 0.36		APPR: MRAMAKRISHNA 2023/08/24									
0 PLACES ±		INITIAL REVISION:									
DRAFT WHERE APPLICABLE MUST REMAIN WITHIN DIMENSIONS		THIRD ANGLE PROJECTION		DRAWING		SERIES		MATERIAL NUMBER		CUSTOMER	
		A3-SIZE		206832		2018/05/08		2019/04/02		2068320000-SD	
		PSD		000		C		2 OF 4			

9 8 7 6 5 4 3 2 1

CKT	POLARIZATION "A"- BLACK	POLARIZATION "B"- NATURAL	POLARIZATION "C" - RED	POLARIZATION "D" - BLUE	POLARIZATION "E" - YELLOW
2					
4					
6					
8					
10					
12					

Ⓒ

SYMBOLS = 0 = 0 = 0 = 0 = 0 = 0 = 0 = 0 = 0 = 0	THIS DRAWING CONTAINS INFORMATION THAT IS PROPRIETARY TO MOLEX ELECTRONIC TECHNOLOGIES, LLC AND SHOULD NOT BE USED WITHOUT WRITTEN PERMISSION DIMENSION UNITS: mm SCALE: 1:1 GENERAL TOLERANCES (UNLESS SPECIFIED) ANGULAR TOL ± 0.5°	CURRENT REV DESC: EC NO: 760703 DRWN: VENKAS5 2023/03/30 CHK'D: VENKAS5 2023/08/24 APPR: MRAMAKRISHNA 2023/08/24 INITIAL REVISION: DRWN: SMAHAJANSHET 2018/05/08 APPR: NCSR 2019/04/02			
	V HDR ASSY BANDO MICRO-FIT + SOLUTION		PRODUCT CUSTOMER DRAWING		
DOCUMENT NUMBER: 2068320000-SD		DOC TYPE: PSD	DOC PART: 000	REVISION: C	
DRAFT WHERE APPLICABLE MUST REMAIN WITHIN DIMENSIONS		THIRD ANGLE PROJECTION	DRAWING: A3-SIZE	SERIES: 206832	MATERIAL NUMBER: SEE TABLE
		CUSTOMER: GENERAL MARKET		SHEET NUMBER: 3 OF 4	

9 8 7 6 5 4 3 2 1

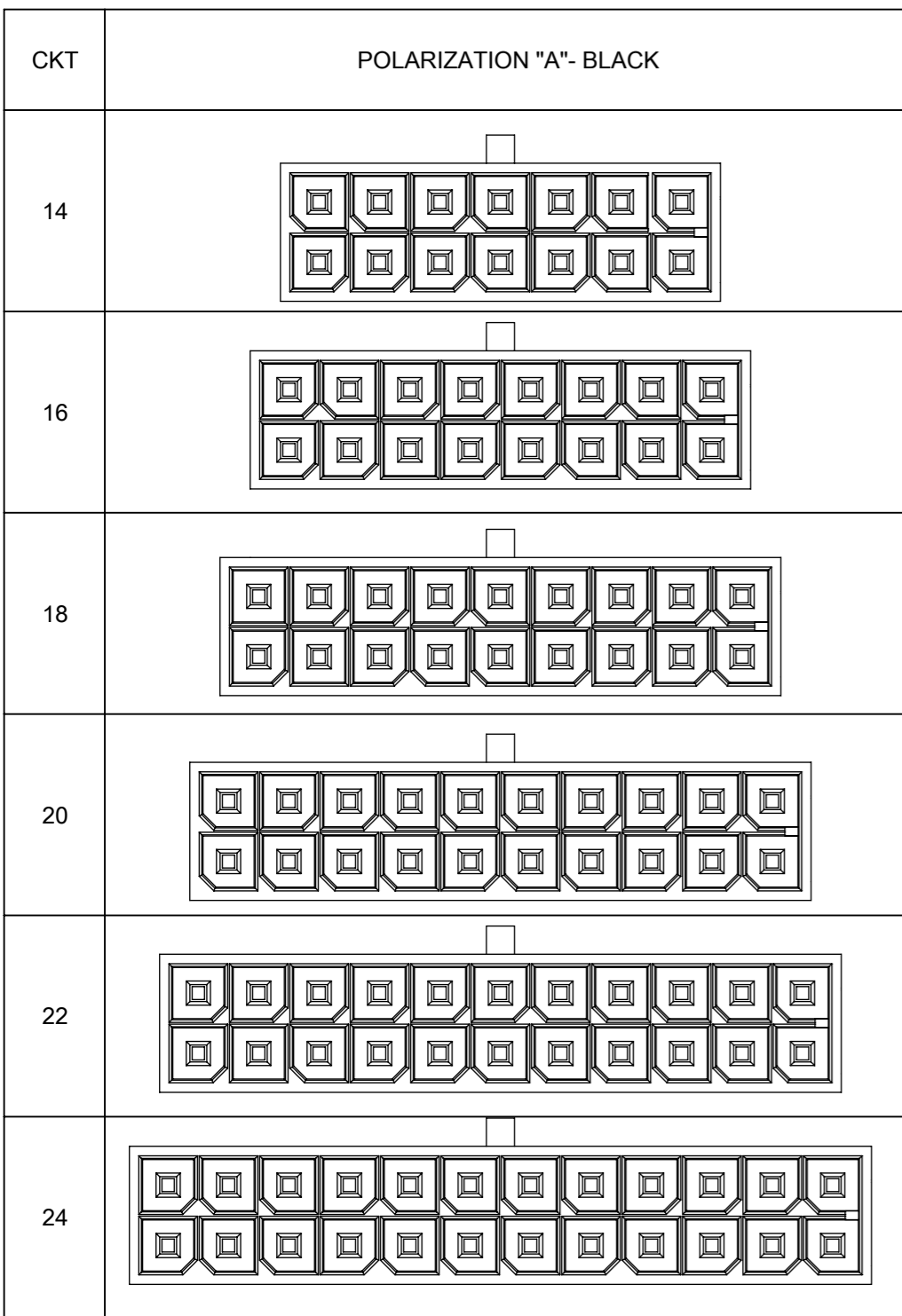

FUNCTIONAL SYMBOLS	THIS DRAWING CONTAINS INFORMATION THAT IS PROPRIETARY TO MOLEX ELECTRONIC TECHNOLOGIES, LLC AND SHOULD NOT BE USED WITHOUT WRITTEN PERMISSION		CURRENT REV DESC:					
	$\nabla_A = 0$ $\nabla_F = 0$ $\nabla_V = 0$	DIMENSION UNITS mm						
DIVISIONAL SYMBOLS	4 PLACES \pm	EC NO: 760703		2023/03/30		PRODUCT CUSTOMER DRAWING		
	3 PLACES \pm	DRWN: VENKAS5		2023/08/24				
	2 PLACES ± 0.13	CHK'D: VENKAS5		2023/08/24		DOCUMENT NUMBER		
	1 PLACE ± 0.25	APPR: MRAMAKRISHNA		2018/05/08		2068320000-SD		
	0 PLACES \pm	INITIAL REVISION:		2019/04/02		PSD 000 C		
DRAFT WHERE APPLICABLE MUST REMAIN WITHIN DIMENSIONS		THIRD ANGLE PROJECTION		DRAWING	SERIES	MATERIAL NUMBER	CUSTOMER	SHEET NUMBER
				A3-SIZE	206832		GENERAL MARKET	4 OF 4