

CKT	A	B
2	3.85	NA
4	6.85	3
6	9.85	6
8	12.85	9
10	15.85	12
12	18.85	15
14	21.85	18
16	24.85	21
18	27.85	24
20	30.85	27
22	33.85	30
24	36.85	33

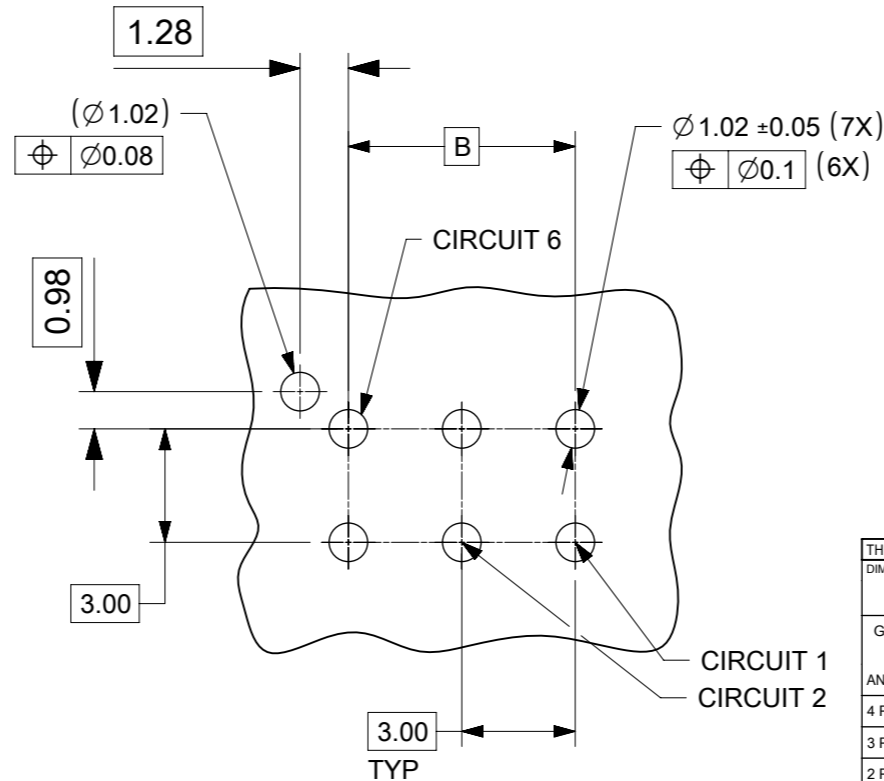
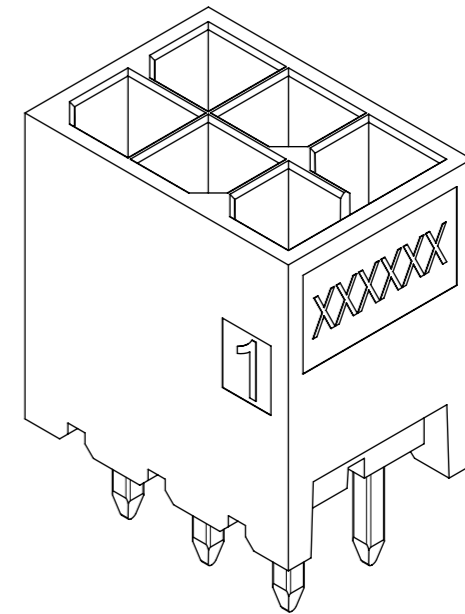
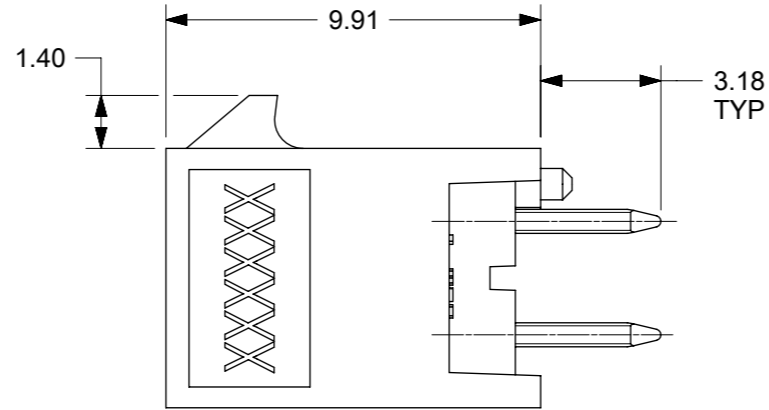
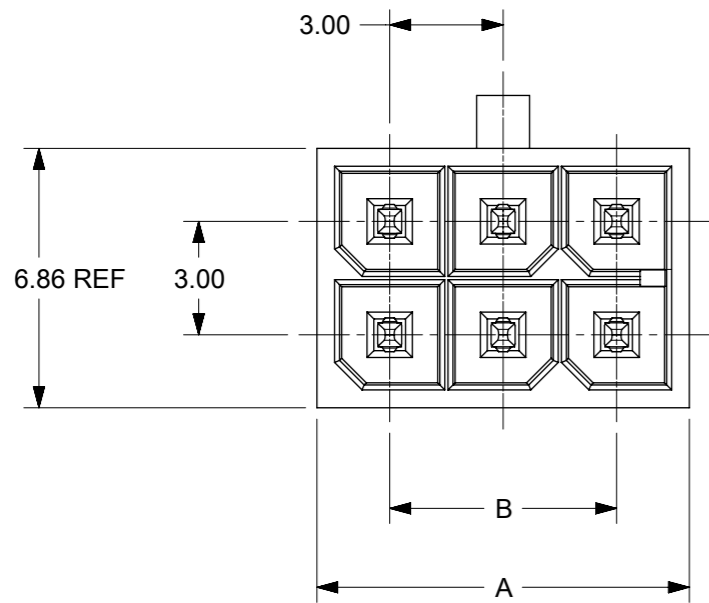
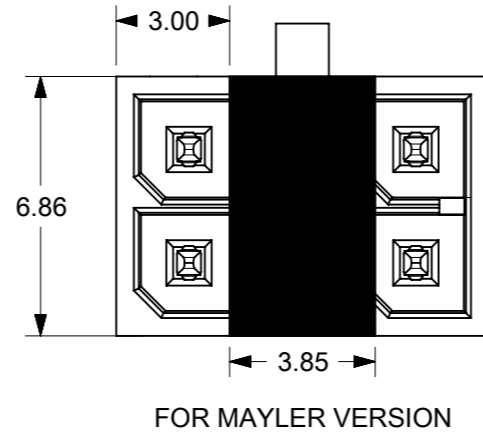
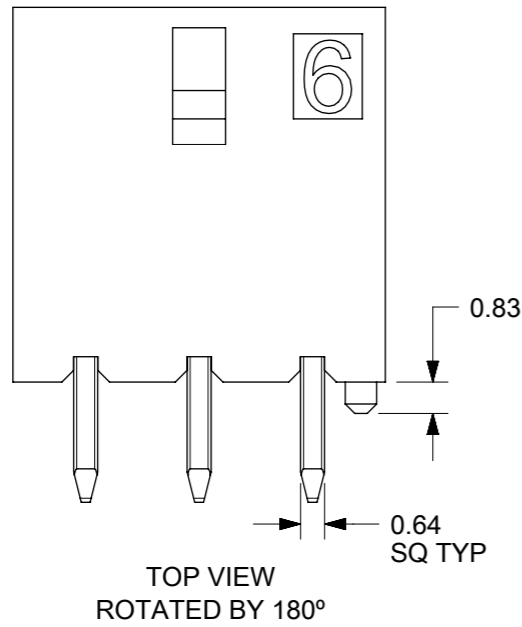

PCB LAYOUT: COMPONENT SIDE
RECOMENDED PCB THICKNESS: .062/1.57 Max.

NOTES:

- HOSING MATERIAL: GLASS FILLED LIQUID CRYSTAL POLYMER, UL 94V-0, COLOR: BLACK
TERMINAL MATERIAL: HIGH COPPER ALLOY
- FINISH:
OPTION 1: TIN OVER NICKEL OVERALL
OPTION 2: SELECT 15MICROINCH GOLD AND SELECT MATTE TIN OVER NICKEL.
OPTION 3: SELECT 30MICROINCH GOLD AND SELECT MATTE TIN OVER NICKEL.
- PRODUCT SPECIFICATION : 2064600000-PS
- TRAY PACK : 2068320000-PK
TAPE REEL PACK : 2068320001-PK
- MATE WITH RECEPTACLE 206461
- THIS PART CONFORMS TO CLASS 'B' REQUIREMENTS OF COSMETIC SPECIFICATION PS-45499-002.

DIMENSION UNITS		SCALE	CURRENT REV DESC:							
mm		5:1								
GENERAL TOLERANCES (UNLESS SPECIFIED)			<p>molex</p> <p>V HDR ASSY BANDO MICRO-FIT + SOLUTION</p> <p>PRODUCT CUSTOMER DRAWING</p>							
ANGULAR TOL ± 0.5°										
4 PLACES ±										
3 PLACES ±										
2 PLACES ± 0.25										
1 PLACE ± 0.36										
0 PLACES ±			<p>INITIAL REVISION:</p> <p>DRWN: SMAHAJANSHET 2018/05/08</p> <p>APPR: NCSR 2019/04/02</p>							
DRAFT WHERE APPLICABLE MUST REMAIN WITHIN DIMENSIONS		THIRD ANGLE PROJECTION	DRAWING	SERIES	MATERIAL NUMBER	CUSTOMER	DOCUMENT NUMBER	DOC TYPE	DOC PART	REVISION
			A3-SIZE	206832	SEE TABLE	GENERAL MARKET	2068320000-SD	PSD	000	C
DOCUMENT STATUS		P1	RELEASE DATE	2023/08/24	11:19:05					

TIN PLATING				30 MICROINCH GOLD				15 MICROINCH GOLD				TIN PLATING							
TRAY PACKAGING -2068320000-PK				TRAY PACKAGING -2068320000-PK				TRAY PACKAGING -2068320000-PK				T&R PACKAGING -2068320001-PK							
CKT	VRT HDR ASSY PN	POLARIZATION	COLOR	CKT	VRT HDR ASSY PN	POLARIZATION	COLOR	CKT	VRT HDR ASSY PN	POLARIZATION	COLOR	CKT	VRT HDR ASSY PN	POLARIZATION	COLOR				
F	2068320201	A	BLACK	2	2068320203	A	BLACK	2	2068320202	A	BLACK	2	206832-0221	A	BLACK				
	2242460210	B	NATURAL		2242460212	B	NATURAL		2242460211	B	NATURAL								
	2242460220	C	RED		2242460222	C	RED		2242460221	C	RED								
	2242460230	D	BLUE		2242460232	D	BLUE		2242460231	D	BLUE								
	2242460240	E	YELLOW		2242460242	E	YELLOW		2242460241	E	YELLOW								
4	2068320401	A	BLACK	4	2068320403	A	BLACK	4	2068320402	A	BLACK		4			206832-0421			
	2242460410	B	NATURAL		2242460412	B	NATURAL		2242460411	B	NATURAL		6			206832-0621			
	2242460420	C	RED		2242460422	C	RED		2242460421	C	RED		8			206832-0821			
	2242460430	D	BLUE		2242460432	D	BLUE		2242460431	D	BLUE		10			206832-1021			
	2242460440	E	YELLOW		2242460442	E	YELLOW		2242460441	E	YELLOW		12			206832-1221			
E	2068320601	A	BLACK	6	2068320603	A	BLACK	6	2068320602	A	BLACK		14			206832-1421			
	2242460610	B	NATURAL		2242460612	B	NATURAL		2242460611	B	NATURAL		16			206832-1621			
	2242460620	C	RED		2242460622	C	RED		2242460621	C	RED		18			206832-1821			
	2242460630	D	BLUE		2242460632	D	BLUE		2242460631	D	BLUE		20			206832-2021			
	2242460640	E	YELLOW		2242460642	E	YELLOW		2242460641	E	YELLOW		22			206832-2221			
8	2068320801	A	BLACK	8	2068320803	A	BLACK	8	2068320802	A	BLACK		24			206832-2421			
	2242460810	B	NATURAL		2242460812	B	NATURAL		2242460811	B	NATURAL		15 MICROINCH GOLD T&R PACKAGING -2068320001-PK						
	2242460820	C	RED		2242460822	C	RED		2242460821	C	RED								
	2242460830	D	BLUE		2242460832	D	BLUE		2242460831	D	BLUE								
	2242460840	E	YELLOW		2242460842	E	YELLOW		2242460841	E	YELLOW								
D	2068321001	A	BLACK	10	2068321003	A	BLACK	10	2068321002	A	BLACK					2	206832-0222		
	2242461010	B	NATURAL		2242461012	B	NATURAL		2242461011	B	NATURAL					4	206832-0422		
	2242461020	C	RED		2242461022	C	RED		2242461021	C	RED					6	206832-0622		
	2242461030	D	BLUE		2242461032	D	BLUE		2242461031	D	BLUE					8	206832-0822		
	2242461040	E	YELLOW		2242461042	E	YELLOW		2242461041	E	YELLOW	10				206832-1022			
12	2068321201	A	BLACK	12	2068321203	A	BLACK	12	2068321202	A	BLACK	12				206832-1222			
	2242461210	B	NATURAL		2242461212	B	NATURAL		2242461211	B	NATURAL	14				206832-1422			
	2242461220	C	RED		2242461222	C	RED		2242461221	C	RED	16				206832-1622			
	2242461230	D	BLUE		2242461232	D	BLUE		2242461231	D	BLUE	18				206832-1822			
	2242461240	E	YELLOW		2242461242	E	YELLOW		2242461241	E	YELLOW	20				206832-2022			
C	2068321401	A	BLACK	14	2068321403	A	BLACK	14	2068321402	A	BLACK	22				206832-2222			
	2068321601	A	BLACK		2068321603	A	BLACK		2068321602	A	BLACK	24				206832-2422			
	2068321801	A	BLACK		2068321803	A	BLACK		2068321802	A	BLACK	30 MICROINCH GOLD T&R PACKAGING -2068320001-PK							
	2068322001	A	BLACK		2068322003	A	BLACK		2068322002	A	BLACK								
	2068322201	A	BLACK		2068322203	A	BLACK		2068322202	A	BLACK								
206832-2401	A	BLACK	206832-2403	A	BLACK	206832-2402	A	BLACK											

TIN PLATING				30 MICROINCH GOLD				15 MICROINCH GOLD				TIN PLATING										
TRAY PACKAGING -2068320000-PK				TRAY PACKAGING -2068320000-PK				TRAY PACKAGING -2068320000-PK				T&R PACKAGING -2068320001-PK										
CKT	VRT HDR ASSY PN	POLARIZATION	COLOR	CKT	VRT HDR ASSY PN	POLARIZATION	COLOR	CKT	VRT HDR ASSY PN	POLARIZATION	COLOR	CKT	VRT HDR ASSY PN	POLARIZATION	COLOR							
B	2068320201	A	BLACK	2	2068320203	A	BLACK	2	2068320202	A	BLACK	2	206832-0221	A	BLACK							
	2242460210	B	NATURAL		2242460212	B	NATURAL		2242460211	B	NATURAL											
	2242460220	C	RED		2242460222	C	RED		2242460221	C	RED											
	2242460230	D	BLUE		2242460232	D	BLUE		2242460231	D	BLUE											
	2242460240	E	YELLOW		2242460242	E	YELLOW		2242460241	E	YELLOW											
	4	2068320401	A		BLACK	4	2068320403		A	BLACK	4		2068320402			A	BLACK	4	206832-0421			
		2242460410	B		NATURAL		2242460412		B	NATURAL			2242460411			B	NATURAL	6	206832-0621			
		2242460420	C		RED		2242460422		C	RED			2242460421			C	RED	8	206832-0821			
		2242460430	D		BLUE		2242460432		D	BLUE			2242460431			D	BLUE	10	206832-1021			
		2242460440	E		YELLOW		2242460442		E	YELLOW			2242460441			E	YELLOW	12	206832-1221			
	E	2068320601	A		BLACK	6	2068320603		A	BLACK	6		2068320602			A	BLACK	14	206832-1421			
		2242460610	B		NATURAL		2242460612		B	NATURAL			2242460611			B	NATURAL	16	206832-1621			
		2242460620	C		RED		2242460622		C	RED			2242460621			C	RED	18	206832-1821			
		2242460630	D		BLUE		2242460632		D	BLUE			2242460631			D	BLUE	20	206832-2021			
		2242460640	E		YELLOW		2242460642		E	YELLOW			2242460641			E	YELLOW	22	206832-2221			
	8	2068320801	A		BLACK	8	2068320803		A	BLACK	8		2068320802			A	BLACK	24	206832-2421			
		2242460810	B		NATURAL		2242460812		B	NATURAL			2242460811			B	NATURAL	15 MICROINCH GOLD T&R PACKAGING -2068320001-PK				
		2242460820	C		RED		2242460822		C	RED			2242460821			C	RED					
		2242460830	D		BLUE		2242460832		D	BLUE			2242460831			D	BLUE					
		2242460840	E		YELLOW		2242460842		E	YELLOW			2242460841			E	YELLOW					
	D	2068321001	A		BLACK	10	2068321003		A	BLACK	10		2068321002			A	BLACK				2	206832-0222
		2242461010	B		NATURAL		2242461012		B	NATURAL			2242461011			B	NATURAL				4	206832-0422
		2242461020	C		RED		2242461022		C	RED			2242461021			C	RED				6	206832-0622
		2242461030	D		BLUE		2242461032		D	BLUE			2242461031			D	BLUE				8	206832-0822
2242461040		E	YELLOW	2242461042	E		YELLOW	2242461041	E	YELLOW		10	206832-1022									
12	2068321201	A	BLACK	12	2068321203	A	BLACK	12	2068321202	A	BLACK	12	206832-1222									
	2242461210	B	NATURAL		2242461212	B	NATURAL		2242461211	B	NATURAL	14	206832-1422									
	2242461220	C	RED		2242461222	C	RED		2242461221	C	RED	16	206832-1622									
	2242461230	D	BLUE		2242461232	D	BLUE		2242461231	D	BLUE	18	206832-1822									
	2242461240	E	YELLOW		2242461242	E	YELLOW		2242461241	E	YELLOW	20	206832-2022									
C	2068321401	A	BLACK	14	2068321403	A	BLACK	14	2068321402	A	BLACK	22	206832-2222									
	2068321601	A	BLACK		2068321603	A	BLACK		2068321602	A	BLACK	24	206832-2422									
	2068321801	A	BLACK		2068321803	A	BLACK		2068321802	A	BLACK	30 MICROINCH GOLD T&R PACKAGING -2068320001-PK										
	2068322001	A	BLACK		2068322003	A	BLACK		2068322002	A	BLACK											
	2068322201	A	BLACK		2068322203	A	BLACK		2068322202	A	BLACK											
206832-2401	A	BLACK	206832-2403	A	BLACK	206832-2402	A	BLACK														

THIS DRAWING CONTAINS INFORMATION THAT IS PROPRIETARY TO MOLEX ELECTRONIC TECHNOLOGIES, LLC AND SHOULD NOT BE USED WITHOUT WRITTEN PERMISSION		CURRENT REV DESC:		molex	
DIMENSION UNITS	SCALE	EC NO: 760703			
mm	1:1	DRWN: VENKASS 2023/03/30		V HDR ASSY BANDO MICRO-FIT + SOLUTION	
GENERAL TOLERANCES (UNLESS SPECIFIED)		CHK'D: VENKASS 2023/08/24			
ANGULAR TOL	± 0.5°	APPR: MRAMAKRISHNA 2023/08/24		PRODUCT CUSTOMER DRAWING	
4 PLACES	±	INITIAL REVISION:		DOCUMENT NUMBER	
3 PLACES	±	DRWN: SMAHAJANSHET 2018/05/08		2068320000-SD	
2 PLACES	± 0.25	APPR: NCSR 2019/04/02		DOC TYPE	DOC PART
1 PLACE	± 0.36			PSD	000
0 PLACES	±			C	
DRAFT WHERE APPLICABLE MUST REMAIN WITHIN DIMENSIONS		THIRD ANGLE PROJECTION	DRAWING	SERIES	MATERIAL NUMBER
			A3-SIZE	206832	SEE TABLE
				CUSTOMER	SHEET NUMBER
				GENERAL MARKET	2 OF 4

9 8 7 6 5 4 3 2 1

CKT	POLARIZATION "A"- BLACK	POLARIZATION "B"- NATURAL	POLARIZATION "C" - RED	POLARIZATION "D" - BLUE	POLARIZATION "E" - YELLOW
2					
4					
6					
8					
10					
12					

Ⓒ

SYMBOLS = 0 = 0 = 0 = 0 = 0 = 0 = 0 = 0 = 0 = 0 = 0	THIS DRAWING CONTAINS INFORMATION THAT IS PROPRIETARY TO MOLEX ELECTRONIC TECHNOLOGIES, LLC AND SHOULD NOT BE USED WITHOUT WRITTEN PERMISSION DIMENSION UNITS: mm SCALE: 1:1	CURRENT REV DESC: EC NO: 760703 DRWN: VENKAS5 2023/03/30 CHK'D: VENKAS5 2023/08/24 APPR: MRAMAKRISHNA 2023/08/24 INITIAL REVISION: DRWN: SMAHAJANSHET 2018/05/08 APPR: NCSR 2019/04/02			
	GENERAL TOLERANCES (UNLESS SPECIFIED) ANGULAR TOL ± 0.5°		V HDR ASSY BANDO MICRO-FIT + SOLUTION		
	4 PLACES ± 3 PLACES ± 2 PLACES ± 0.13 1 PLACE ± 0.25 0 PLACES ±		PRODUCT CUSTOMER DRAWING		
	DRAFT WHERE APPLICABLE MUST REMAIN WITHIN DIMENSIONS THIRD ANGLE PROJECTION 		DOCUMENT NUMBER 2068320000-SD	DOC TYPE PSD	DOC PART 000
	DRAWING A3-SIZE	SERIES 206832	MATERIAL NUMBER SEE TABLE	CUSTOMER GENERAL MARKET	SHEET NUMBER 3 OF 4

9 8 7 6 5 4 3 2 1

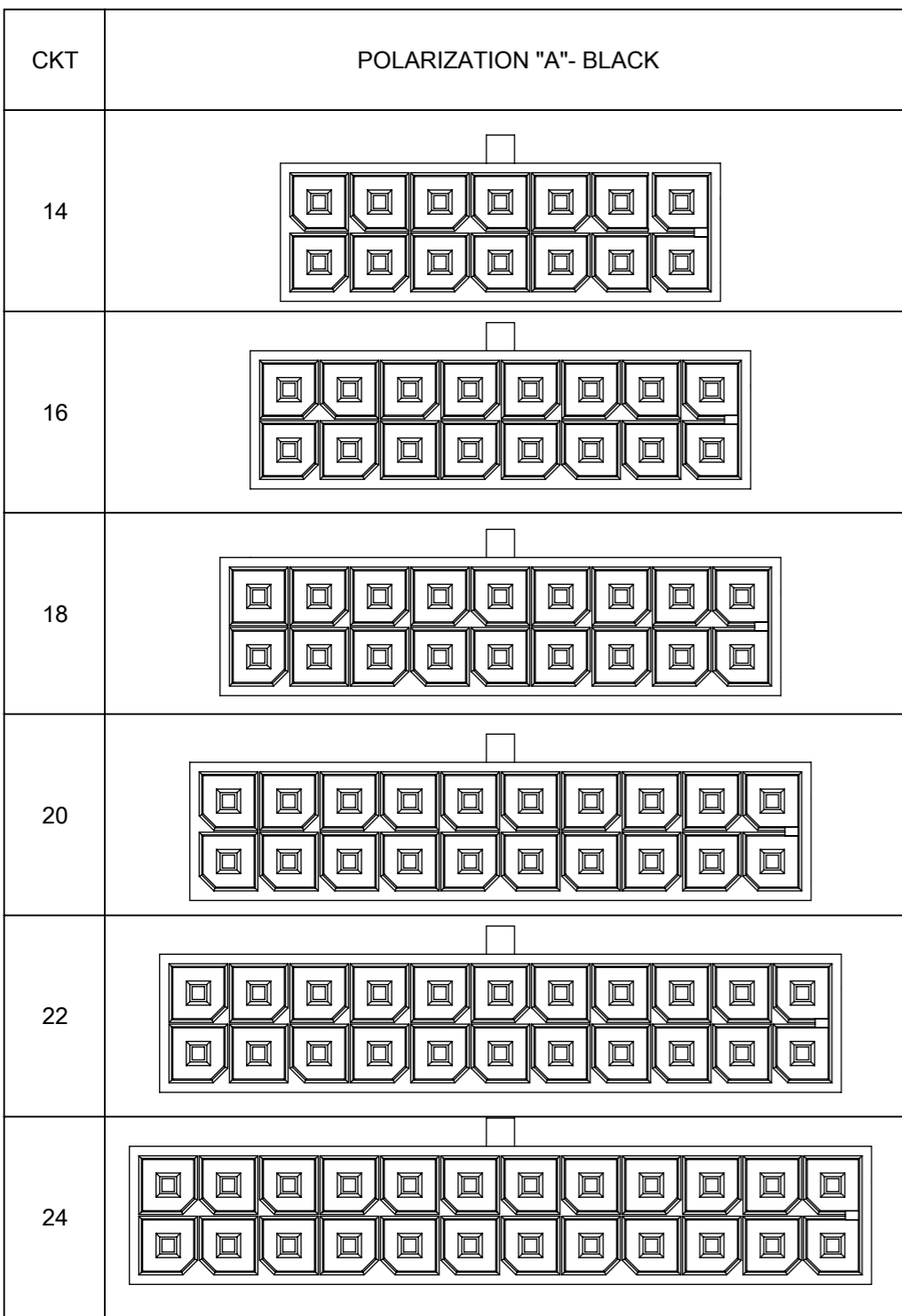

FUNCTIONAL SYMBOLS	THIS DRAWING CONTAINS INFORMATION THAT IS PROPRIETARY TO MOLEX ELECTRONIC TECHNOLOGIES, LLC AND SHOULD NOT BE USED WITHOUT WRITTEN PERMISSION		CURRENT REV DESC:					
	$\nabla_A = 0$ $\nabla_F = 0$ $\nabla_V = 0$	DIMENSION UNITS mm						
DIVISIONAL SYMBOLS	4 PLACES	\pm	EC NO: 760703	2023/03/30	V HDR ASSY BANDO MICRO-FIT + SOLUTION			
	3 PLACES	\pm	DRWN: VENKAS5	2023/08/24				
	2 PLACES	± 0.13	CHK'D: VENKAS5	2023/08/24	PRODUCT CUSTOMER DRAWING			
	1 PLACE	± 0.25	APPR: MRAMAKRISHNA	2023/08/24				
	0 PLACES	\pm	INITIAL REVISION:		DOCUMENT NUMBER	DOC TYPE	DOC PART	REVISION
DRAFT WHERE APPLICABLE MUST REMAIN WITHIN DIMENSIONS		THIRD ANGLE PROJECTION	DRAWING	SERIES	MATERIAL NUMBER	CUSTOMER	SHEET NUMBER	
			A3-SIZE	206832	2068320000-SD	GENERAL MARKET	4 OF 4	