

# FREE HANGING PLUG PARTS

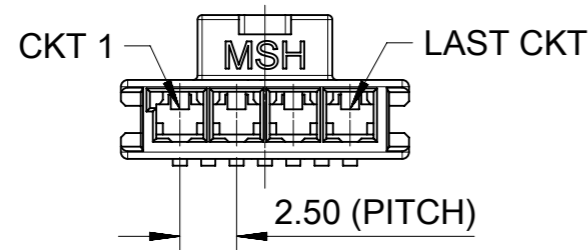

COLOR FEATURE	
BLACK	NATURAL
KEY A	KEY B

**NOTES:**

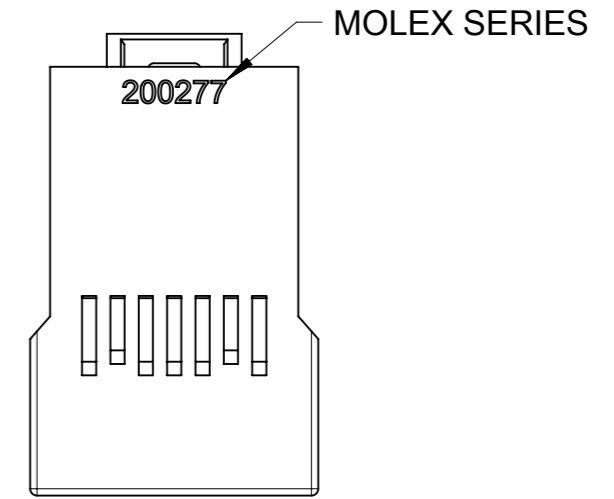
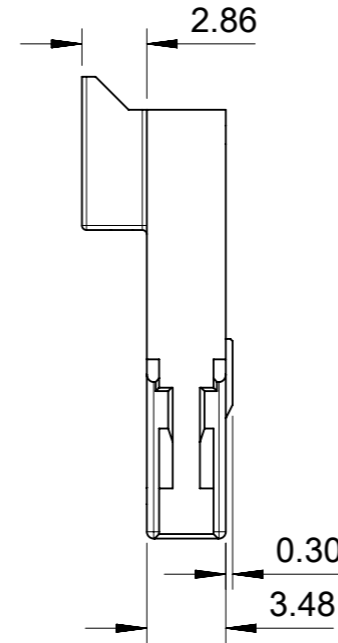
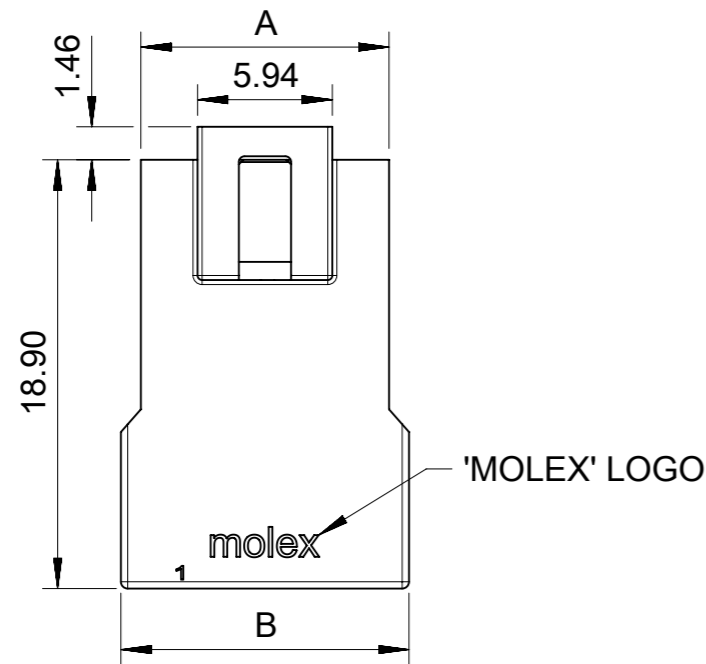





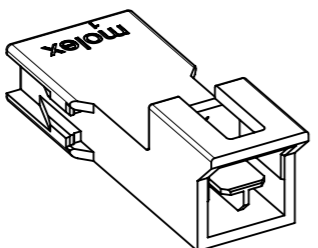
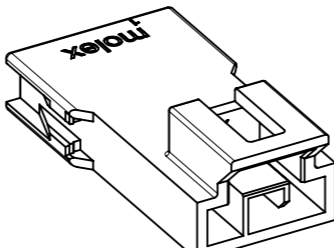
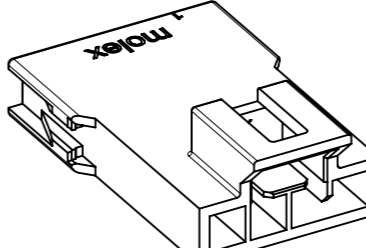
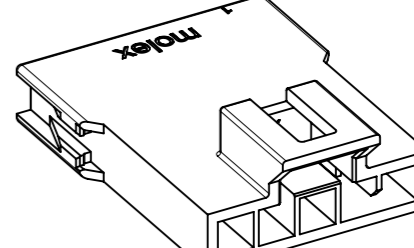
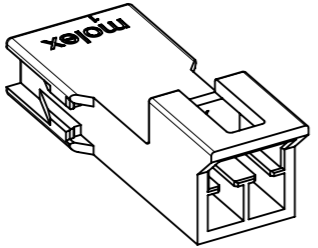
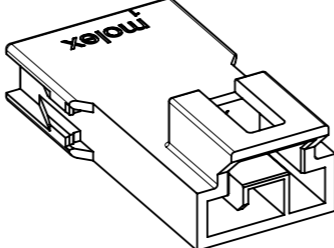
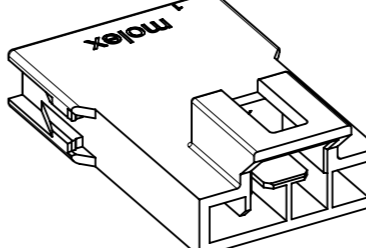
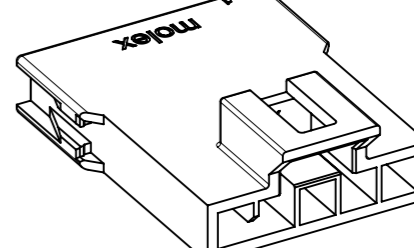
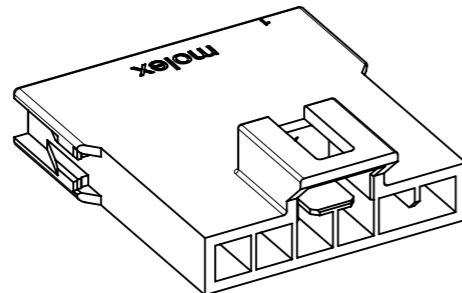
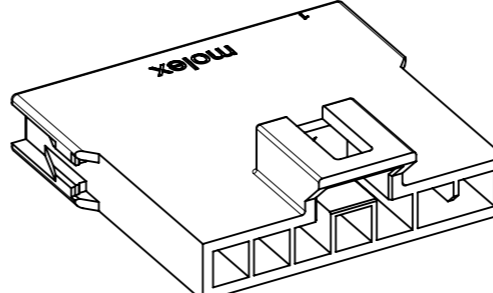
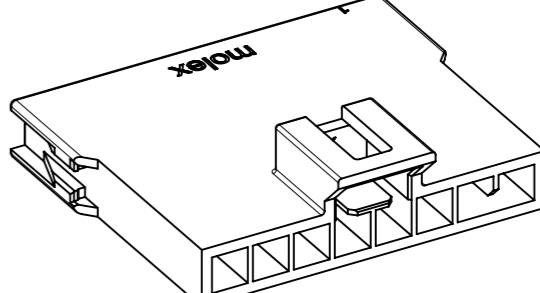
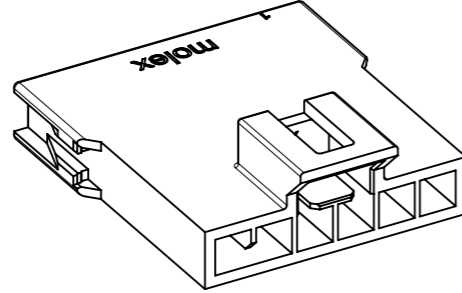
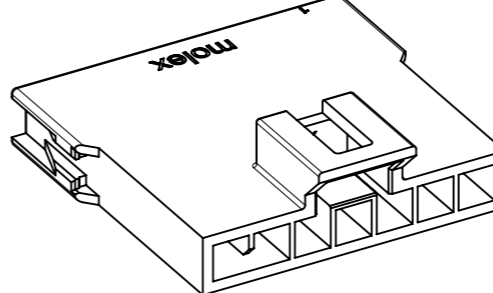
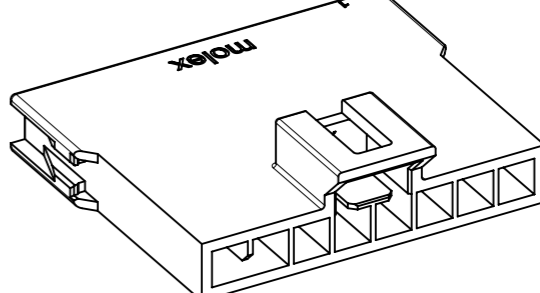

- MATERIAL:  
 OPTION 1: PA66, 94V-0, BLACK  
 OPTION 2: PA66, 94V-0, NATUAL.
- PRODUCT SPECIFICATION: 2014471000-PS.
- PACKAGE SPECIFICATION: 2002771000-PK.
- THE COMPONENT COMPLIANT TO RoHS DIRECTIVE 2011/65/EU AND ELV DIRECTIVE 2000/53/EC.
- TO MATE WITH TERMINAL OF 201447-\*\*\*\*.  
 TO MATE WITH TPA OF 105325-\*\*\*\*.  
 TO MATE WITH RECEPTACLE OF 105307-\*\*\*\*.
- PARTS CONFORM TO CLASS 'B' REQUIREMENTS OF COSMETIC SPECIFICATION PS-45499-002.
- APPLICATION SPECIFICATION: 201447-AS.

<b>SYMBOLS</b> ▽ = 0 ▽ = 0 ▽ = 0 ▽ = 0 ▽ = 0 ▽ = 0 ▽ = 0 ▽ = 0 ▽ = 0 ▽ = 0 ▽ = 0	THIS DRAWING CONTAINS INFORMATION THAT IS PROPRIETARY TO MOLEX ELECTRONIC TECHNOLOGIES, LLC AND SHOULD NOT BE USED WITHOUT WRITTEN PERMISSION DIMENSION UNITS: <b>mm</b> SCALE: <b>3:1</b>	CURRENT REV DESC: EC NO: 615493 DRWN: GLLI 2019/03/06 CHK'D: AYIN 2019/04/17 APPR: AYIN 2019/04/17	 PLUG HOUSING OF NANO-FIT WTW SR POWER CONNECTOR		
	GENERAL TOLERANCES (UNLESS SPECIFIED) ANGULAR TOL ± ° 4 PLACES ± 3 PLACES ± 2 PLACES ± 0.15 1 PLACE ± 0 PLACES ±	INITIAL REVISION: DRWN: GLLI 2018/07/19 APPR: AYIN 2019/04/17			
	DRAFT WHERE APPLICABLE MUST REMAIN WITHIN DIMENSIONS THIRD ANGLE PROJECTION DRAWING: A3-SIZE SERIES: 200277	MATERIAL NUMBER: SEE SHEET 2 CUSTOMER: GENERAL MARKET	DOCUMENT NUMBER: 2002771000-SD DOC TYPE: PSD DOC PART: 000 REVISION: A	SHEET NUMBER: 1 OF 6	



# FREE HANGING PLUG PARTS

	2 CKT	3 CKT	4 CKT	5 CKT
BLACK				
NATURAL				
	6 CKT	7 CKT	8 CKT	
BLACK				
NATURAL				

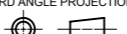
<b>SYMBOLS</b>  = 0  = 0  = 0  = 0  = 0  = 0  = 0  = 0	THIS DRAWING CONTAINS INFORMATION THAT IS PROPRIETARY TO MOLEX ELECTRONIC TECHNOLOGIES, LLC AND SHOULD NOT BE USED WITHOUT WRITTEN PERMISSION DIMENSION UNITS: <b>mm</b> SCALE: <b>2.5:1</b>		CURRENT REV DESC: EC NO: 615493 DRWN: GLLI 2019/03/06 CHK'D: AYIN 2019/04/17 APPR: AYIN 2019/04/17		 PLUG HOUSING OF NANO-FIT WTW SR POWER CONNECTOR
	GENERAL TOLERANCES (UNLESS SPECIFIED) ANGULAR TOL ± ° 4 PLACES ± 3 PLACES ± 2 PLACES ± 0.15 1 PLACE ± 0 PLACES ± DRAFT WHERE APPLICABLE MUST REMAIN WITHIN DIMENSIONS		INITIAL REVISION: DRWN: GLLI 2018/07/19 APPR: AYIN 2019/04/17		
DOCUMENT STATUS: P1 RELEASE DATE: 2019/04/17 03:17:25		THIRD ANGLE PROJECTION:  DRAWING: A3-SIZE SERIES: 200277 MATERIAL NUMBER: SEE SHEET 2 CUSTOMER: GENERAL MARKET SHEET NUMBER: 3 OF 6			





