

- 注記  
NOTES
- 材質  
ハウジング：耐熱性ナイロンUL94V-0  
ピン：銅合金、ニッケル下地、錫メッキ、金メッキ  
フィッティングネール：銅合金、ニッケル下地、錫メッキ  
MATERIAL  
HOUSING:POLYAMIDE UL94V-0  
PIN: COPPER ALLOY, GOLD OR TIN OVER NICKEL PLATE.  
FITTING NAIL: COPPER ALLOY, TIN OVER NICKEL PLATE.
  - 色：ナチュラル、黒、赤、青  
COLOR:NATURAL, BLACK, RED, BLUE
  - 嵌合相手  
ハウジング：502351-\*\*0\*  
錫メッキ端子：50212-8\*00,50372-8\*00,560085-0101  
金メッキ端子：56161-8\*81  
MATES WITH  
HOUSING:502351-\*\*0\*  
SN PLATING TERMINAL:50212-8\*00,50372-8\*00,560085-0101  
AU PLATING TERMINAL:56161-8\*81
  - エンボス梱包品の詳細はSD-502352-002参照  
DETAILED TAPING PACKAGE, SEE SD-502352-002.
  - ELV及びRoHS適合  
ELV AND RoHS COMPLIANT
  - 半田付け面のコプラナリティ：0.1mm MAX.  
CO-PLANARITY OF SOLDERING TAILS TO BE 0.1mm MAX.

- 7.一般公差  
GENERAL TOLERANCES  
10 UNDER: ±0.2  
10 OVER 30 UNDER: ±0.25  
30 OVER: ±0.3  
ANGULAR: ±3°

INITIAL REVISION:  
DRWN SHSHIBATA 2007/12/18  
CHECK HKOMATSU 2007/12/18  
APPR AKANESHIGE 2007/12/18

FUNCTIONAL SYMBOLS ▽A=0 ▽B=0 ▽C=0 DIVISIONAL SYMBOLS	THIS DRAWING CONTAINS INFORMATION THAT IS PROPRIETARY TO MOLEX ELECTRONIC TECHNOLOGIES, LLC AND SHOULD NOT BE USED WITHOUT WRITTEN PERMISSION		CURRENT REV DESC: For fixing wrong view of 6ckt		
	FUNCTIONAL DIMENSION UNITS	SCALE	molex		
	mm	5:1	2.0MM PITCH W/B CONN. WAFER ASSY R/A SMT		
	GENERAL TOLERANCES (UNLESS SPECIFIED)		PRODUCT SALES DRAWING		
ANGULAR TOL ± 0.5°		DOCUMENT NUMBER		DOC TYPE DOC PART REVISION	
4 PLACES ±		SD-502352-001		PSD 001 L4	
3 PLACES ±		SERIES		SHEET NUMBER	
2 PLACES ±		502352		1 OF 4	
1 PLACE ±		MATERIAL NUMBER		CUSTOMER	
0 PLACES ±		SEE CHART		GENERAL MARKET	
DRAFT WHERE APPLICABLE MUST REMAIN WITHIN DIMENSIONS		THIRD ANGLE PROJECTION	DRAWING	A3-SIZE	

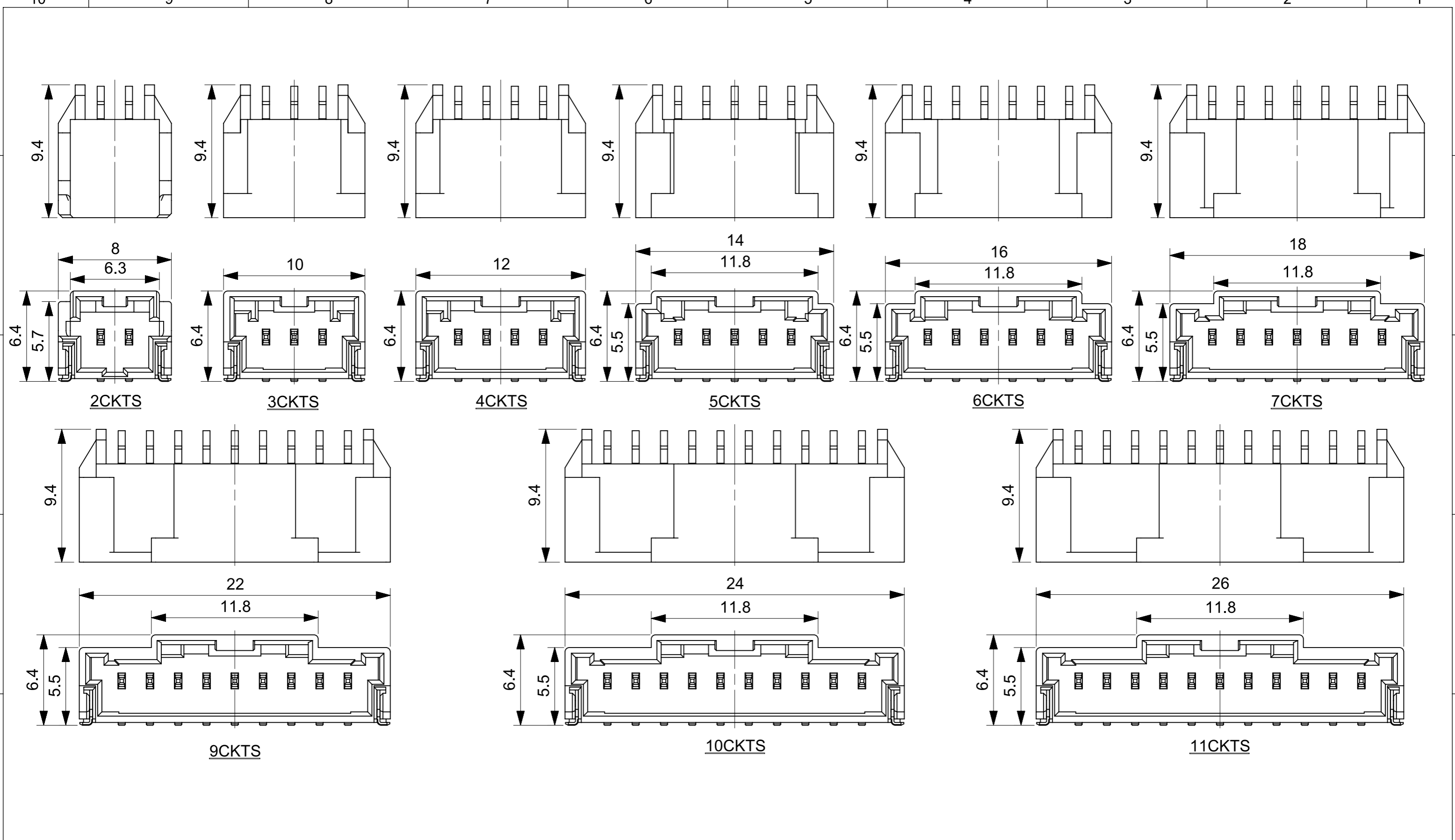

INITIAL REVISION:  
 DRWN SHSHIBATA 2007/12/18  
 CHECK HKOMATSU 2007/12/18  
 APPR AKANESHIGE 2007/12/18

FUNCTIONAL SYMBOLS $\nabla_A = 0$ $\nabla_B = 0$ $\nabla_C = 0$ DIVISIONAL SYMBOLS	THIS DRAWING CONTAINS INFORMATION THAT IS PROPRIETARY TO MOLEX ELECTRONIC TECHNOLOGIES, LLC AND SHOULD NOT BE USED WITHOUT WRITTEN PERMISSION		CURRENT REV DESC: For fixing wrong view of 6ckt	
	DIMENSION UNITS	SCALE		
	mm	4:1		
	GENERAL TOLERANCES (UNLESS SPECIFIED)			
ANGULAR TOL		$\pm 0.5^\circ$		
4 PLACES		±		
3 PLACES		±		
2 PLACES		±		
1 PLACE		±		
0 PLACES		±		
DRAFT WHERE APPLICABLE MUST REMAIN WITHIN DIMENSIONS		THIRD ANGLE PROJECTION	DRAWING	SERIES
			A3-SIZE	502352
STATUS: Production		DRWN: Hideo Yoneyama	2024-05-14	DOCUMENT NUMBER
CHK'D: Hiromichi Komatsu		2024-05-16	2024-05-16	SD-502352-001
APPR: Takashi Iida		2024-05-16	2024-05-16	PSD 001 L4
		MATERIAL NUMBER	CUSTOMER	SHEET NUMBER
		SEE CHART	GENERAL MARKET	2 OF 4

**molex**

2.0MM PITCH W/B CONN.  
 WAFER ASSY R/A SMT

PRODUCT SALES DRAWING

DOCUMENT NUMBER: SD-502352-001  
 DOC TYPE: PSD  
 DOC PART: 001  
 REVISION: L4

GENERAL MARKET

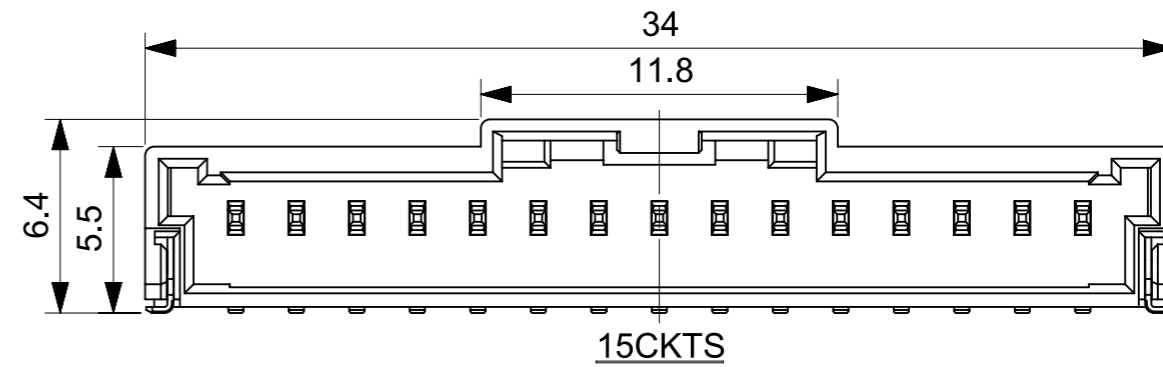
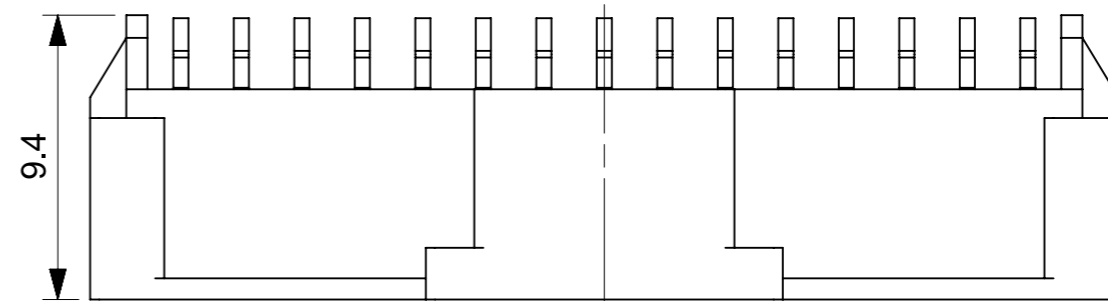
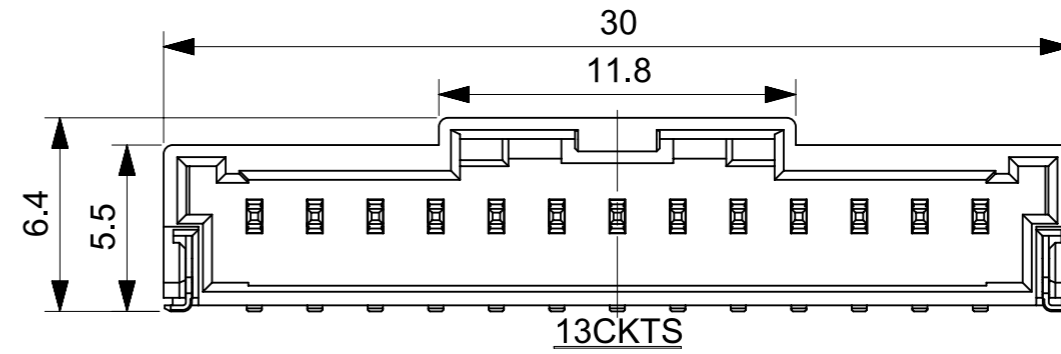
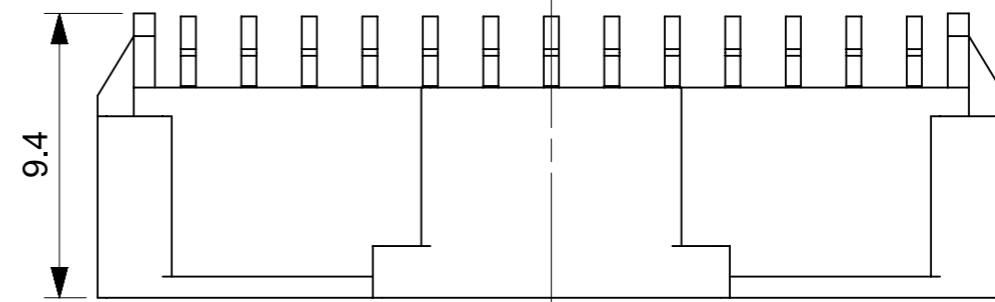
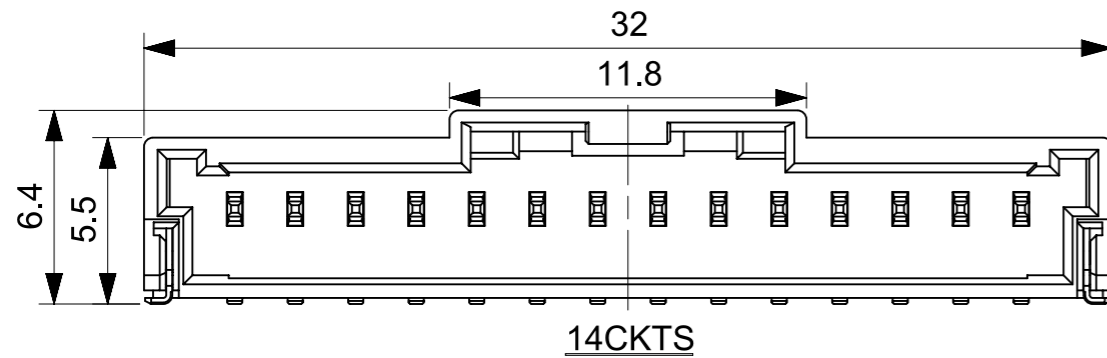
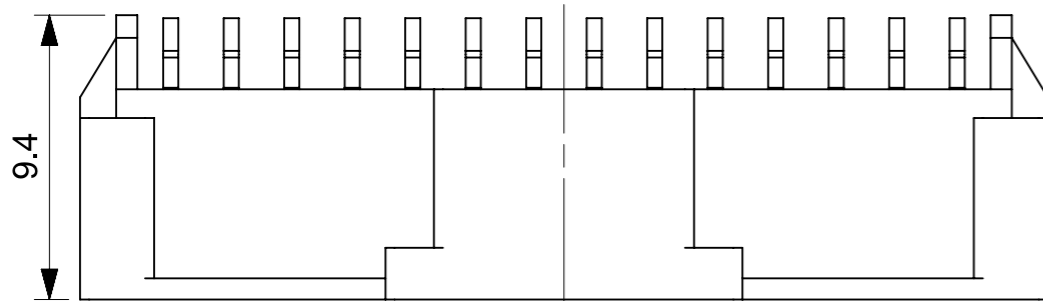
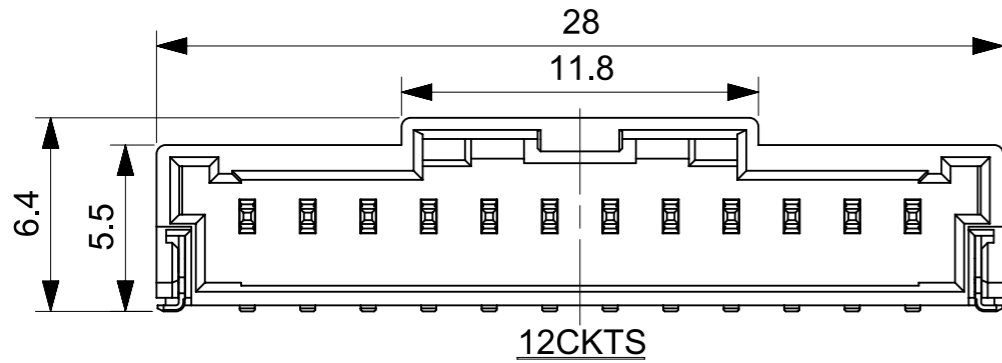
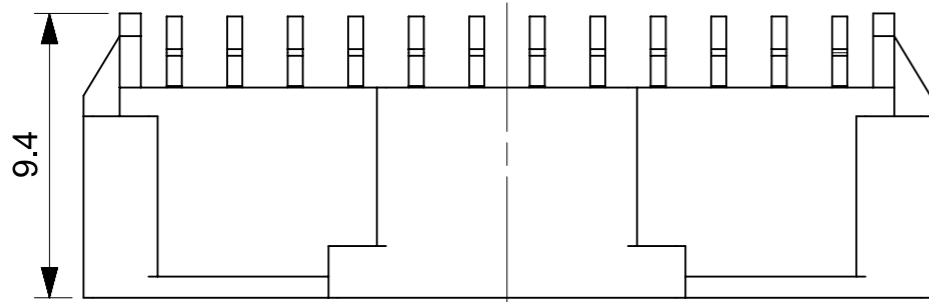

INITIAL REVISION:  
 DRWN SHSHIBATA 2007/12/18  
 CHECK HKOMATSU 2007/12/18  
 APPR AKANESHIGE 2007/12/18

FUNCTIONAL SYMBOLS $\nabla/A = 0$ $\nabla/B = 0$ $\nabla/C = 0$ DIVISIONAL SYMBOLS	THIS DRAWING CONTAINS INFORMATION THAT IS PROPRIETARY TO MOLEX ELECTRONIC TECHNOLOGIES, LLC AND SHOULD NOT BE USED WITHOUT WRITTEN PERMISSION CURRENT REV DESC: For fixing wrong view of 6ckt	
	DIMENSION UNITS <b>mm</b>	SCALE <b>4:1</b>
	GENERAL TOLERANCES (UNLESS SPECIFIED) ANGULAR TOL $\pm 0.5^\circ$ 4 PLACES $\pm$ 3 PLACES $\pm$ 2 PLACES $\pm$ 1 PLACE $\pm$ 0 PLACES $\pm$	
	DRAFT WHERE APPLICABLE MUST REMAIN WITHIN DIMENSIONS THIRD ANGLE PROJECTION 	
STATUS: Production DRWN: Hideo Yoneyama 2024-05-14 CHK'D: Hiromichi Komatsu 2024-05-16 APPR: Takashi Iida 2024-05-16		DOCUMENT NUMBER <b>SD-502352-001</b>
DRAWING <b>A3-SIZE</b>		SERIES <b>502352</b>
MATERIAL NUMBER SEE CHART		CUSTOMER GENERAL MARKET
SHEET NUMBER 3 OF 4		REVISION <b>L4</b>

**molex**

2.0MM PITCH W/B CONN.  
 WAFER ASSY R/A SMT

PRODUCT SALES DRAWING

Sn NATURAL	34.0	502352-1500	15
	32.0	502352-1400	14
	30.0	502352-1300	13
	28.0	502352-1200	12
	26.0	502352-1100	11
	24.0	502352-1000	10
	22.0	502352-0900	9
	20.0	502352-0800	8
	18.0	502352-0700	7
	16.0	502352-0600	6
	14.0	502352-0500	5
	12.0	502352-0400	4
10.0	502352-0300	3	
8.0	502352-0200	2	
PLATING COLOR	A	EMBOSSSED PACKAGE ORDER NO.	CKTS
CONNECTOR SERIES NO. 502352-**08			

Au NATURAL	34.0	502352-1510	15
	32.0	502352-1410	14
	30.0	502352-1310	13
	28.0	502352-1210	12
	26.0	502352-1110	11
	24.0	502352-1010	10
	22.0	502352-0910	9
	20.0	502352-0810	8
	18.0	502352-0710	7
	16.0	502352-0610	6
	14.0	502352-0510	5
	12.0	502352-0410	4
10.0	502352-0310	3	
8.0	502352-0210	2	
PLATING COLOR	A	EMBOSSSED PACKAGE ORDER NO.	CKTS
CONNECTOR SERIES NO. 502352-**18			

Sn BLACK	34.0	502352-1501	15
	32.0	502352-1401	14
	30.0	502352-1301	13
	28.0	502352-1201	12
	26.0	502352-1101	11
	24.0	502352-1001	10
	22.0	502352-0901	9
	20.0	502352-0801	8
	18.0	502352-0701	7
	16.0	502352-0601	6
	14.0	502352-0501	5
	12.0	502352-0401	4
10.0	502352-0301	3	
8.0	502352-0201	2	
PLATING COLOR	A	EMBOSSSED PACKAGE ORDER NO.	CKTS
CONNECTOR SERIES NO. 502352-**28			

Sn RED	-	-	15
	-	-	14
	-	-	13
	-	-	12
	-	-	11
	-	-	10
	-	-	9
	20.0	502352-0802	8
	-	-	7
	16.0	502352-0602	6
	-	-	5
	12.0	502352-0402	4
10.0	502352-0302	3	
8.0	502352-0202	2	
PLATING COLOR	A	EMBOSSSED PACKAGE ORDER NO.	CKTS
CONNECTOR SERIES NO. 502352-**48			

Sn BLUE	-	-	15
	-	-	14
	-	-	13
	-	-	12
	-	-	11
	-	-	10
	-	-	9
	20.0	502352-0803	8
	-	-	7
	16.0	502352-0603	6
	-	-	5
	12.0	502352-0403	4
10.0	502352-0303	3	
8.0	502352-0203	2	
PLATING COLOR	A	EMBOSSSED PACKAGE ORDER NO.	CKTS
CONNECTOR SERIES NO. 502352-**68			

INITIAL REVISION:  
 DRWN SHSHIBATA 2007/12/18  
 CHECK HKOMATSU 2007/12/18  
 APPR AKANESHIGE 2007/12/18

FUNCTIONAL SYMBOLS				THIS DRAWING CONTAINS INFORMATION THAT IS PROPRIETARY TO MOLEX ELECTRONIC TECHNOLOGIES, LLC AND SHOULD NOT BE USED WITHOUT WRITTEN PERMISSION											
DIMENSION UNITS		SCALE		CURRENT REV DESC: For fixing wrong view of 6ckt											
mm		1:1													
GENERAL TOLERANCES (UNLESS SPECIFIED)															
ANGULAR TOL ± 0.5°															
4 PLACES ±															
3 PLACES ±															
2 PLACES ±															
1 PLACE ±															
0 PLACES ±															
DRAFT WHERE APPLICABLE MUST REMAIN WITHIN DIMENSIONS				THIRD ANGLE PROJECTION		DRAWING		SERIES		MATERIAL NUMBER		CUSTOMER		SHEET NUMBER	
				A3-SIZE		502352		SEE CHART		GENERAL MARKET		4 OF 4			
				STATUS: Production				DRWN: Hideo Yoneyama 2024-05-14				DOC TYPE   DOC PART   REVISION			
				CHK'D: Hiromichi Komatsu 2024-05-16				SD-502352-001				PSD 001 L4			
				APPR: Takashi Iida 2024-05-16											

**molex**

2.0MM PITCH W/B CONN.  
 WAFER ASSY R/A SMT

PRODUCT SALES DRAWING

DOCUMENT NUMBER: SD-502352-001 | DOC TYPE: PSD | DOC PART: 001 | REVISION: L4

SEE CHART | GENERAL MARKET | 4 OF 4

注記  
NOTES

- 製品番号  
 ナチュラル・錫めっき: 502352-\*\*00  
 ナチュラル・金めっき: 502352-\*\*10  
 黒・錫めっき: 502352-\*\*01  
 赤・錫めっき: 502352-\*\*02  
 青・錫めっき: 502352-\*\*03  
 詳細寸法については、製品単体図面を参照下さい。  
 PART NO.  
 NATURAL Sn Plating: 502352-\*\*00  
 NATURAL Au Plating: 502352-\*\*10  
 BLACK Sn Plating: 502352-\*\*01  
 RED Sn Plating: 502352-\*\*02  
 BLUE Sn Plating: 502352-\*\*03  
 SEE SALES DRAWING FOR CONNECTOR
- 梱包数量: 700個/リール  
 NUMBER OF CONNECTORS 700PCS/REEL
- リードテープ長さ  
 LEAD TAPE LENGHT
- 材料  
 MATERIAL  
 キャリアテープ: ポリスチレン  
 CARRIER TAPE: POLYSTYRENE  
 トップテープ: PET, PE, PEF  
 TOP TAPE: PET, PE, PEF  
 リール: ポリスチレン  
 REEL: POLYSTYRENE
- 一般公差  
 GENERAL TOLERANCES  
 10 UNDER: ±0.2  
 10 OVER 30 UNDER: ±0.25  
 30 OVER: ±0.3  
 ANGULAR: ±1°

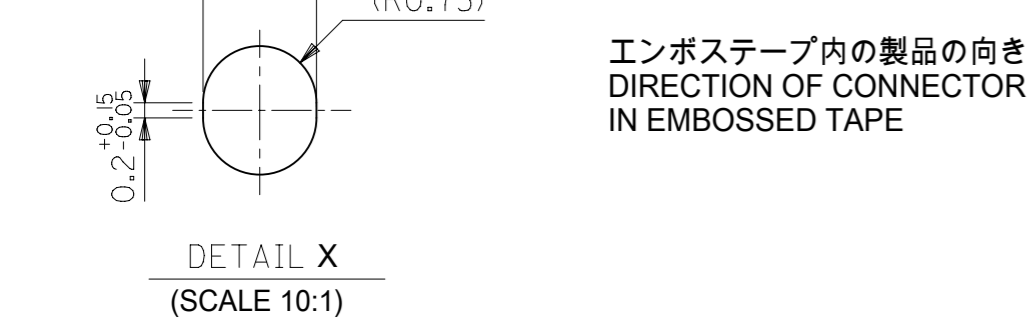
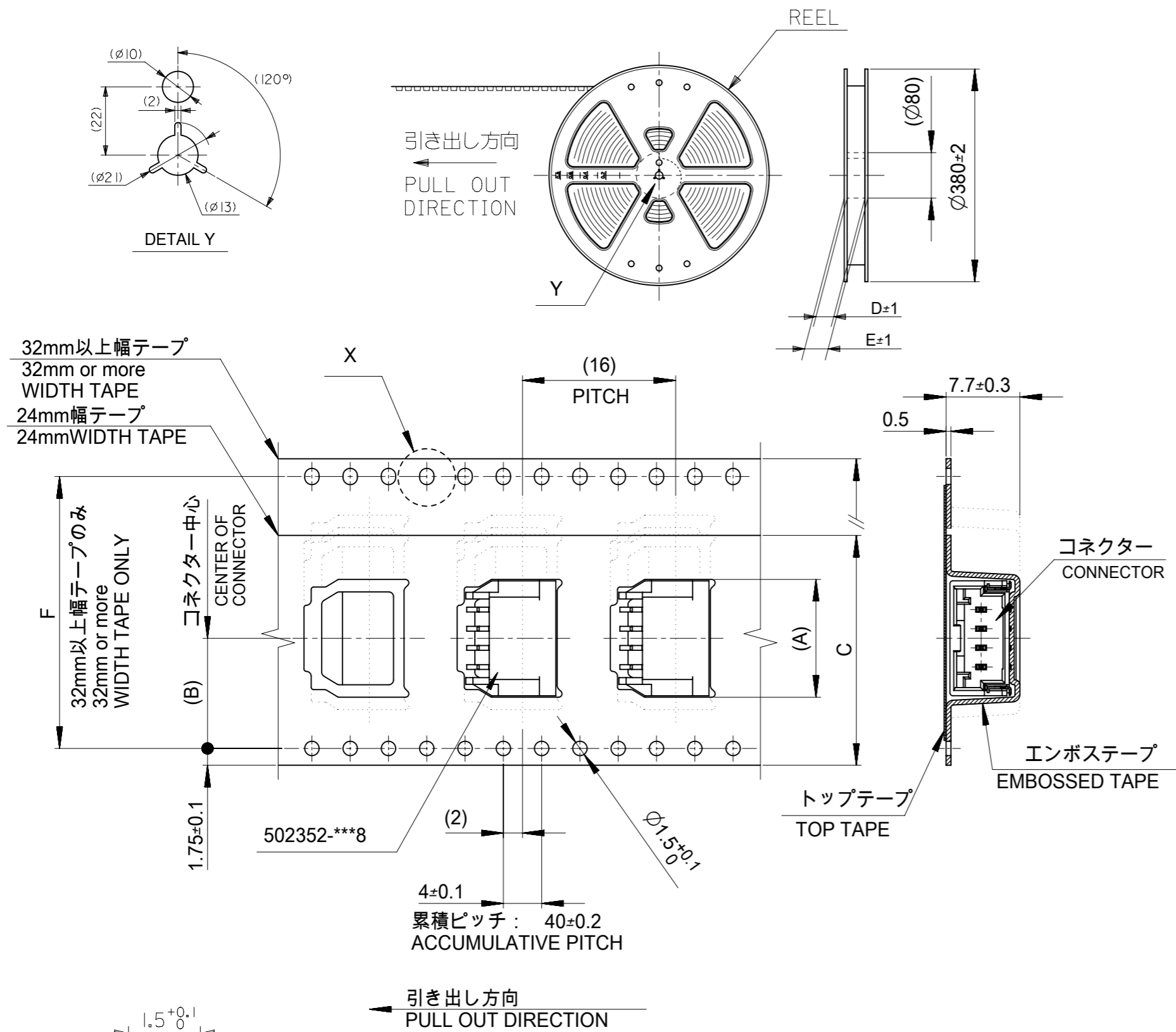
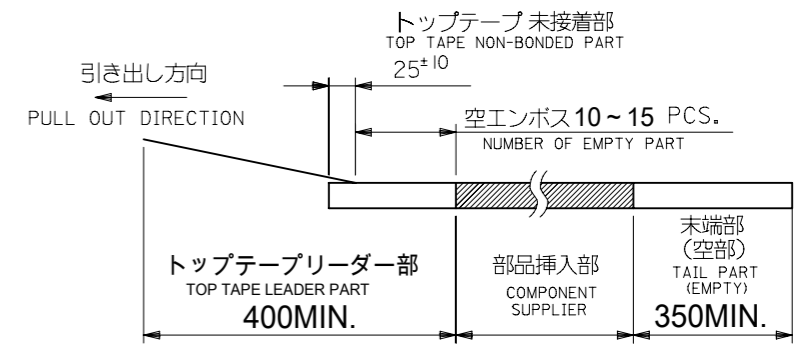

引き出し方向  
PULL OUT DIRECTION

エンボステープ内の製品の向き  
DIRECTION OF CONNECTOR  
IN EMBOSSED TAPE

THIS DRAWING CONTAINS INFORMATION THAT IS PROPRIETARY TO MOLEX ELECTRONIC TECHNOLOGIES, LLC AND SHOULD NOT BE USED WITHOUT WRITTEN PERMISSION		CURRENT REV DESC:		<b>molex</b>	
DIMENSION UNITS: mm	SCALE: NTS				
GENERAL TOLERANCES (UNLESS SPECIFIED)		EC NO: 629663		2.0MM PITCH W/B CONN. WAFER ASSY EMBOSSED TAPE PACKAGE	
ANGULAR TOL	± °	DRWN: MSATO08	2019/12/26	PRODUCT CUSTOMER DRAWING	
4 PLACES	±	CHK'D: HIJIMA	2019/12/27	DOCUMENT NUMBER: SD-502352-002	
3 PLACES	±	APPR: TOSADA	2019/12/27	DOC TYPE: PSD	DOC PART: 001
2 PLACES	±	INITIAL REVISION:		REVISION: K2	
1 PLACE	±	DRWN: SHSHIBATA	2007/06/19	SHEET NUMBER: 1 OF 2	
0 PLACES	±	APPR: AKANESHIGE	2007/06/19		
DRAFT WHERE APPLICABLE MUST REMAIN WITHIN DIMENSIONS		THIRD ANGLE PROJECTION	DRAWING: A3-SIZE	SERIES: 502352	MATERIAL NUMBER: SEE CHART
				CUSTOMER: GENERAL MARKET	

INITIAL REVISION:

DRWN	SHSHIBATA	2007/06/06
CHECK	TAITO	2007/06/06
APPR	MAYAMAMOTO	2012/03/14

E	Sn NATURAL	52.4	61.4	57.4	56	26.2	34.3	502352-1500	15	Au NATURAL	52.4	61.4	57.4	56	26.2	34.3	502352-1510	15
							32.3	502352-1400	14							32.3	502352-1410	14
		40.4	49.4	45.4	44	20.2	30.3	502352-1300	13		40.4	49.4	45.4	44	20.2	30.3	502352-1310	13
							28.3	502352-1200	12							28.3	502352-1210	12
							26.3	502352-1100	11							26.3	502352-1110	11
							24.3	502352-1000	10							24.3	502352-1010	10
							22.3	502352-0900	9							22.3	502352-0910	9
		28.4	37.4	33.4	32	14.2	20.3	502352-0800	8		28.4	37.4	33.4	32	14.2	20.3	502352-0810	8
							18.3	502352-0700	7							18.3	502352-0710	7
							16.3	502352-0600	6							16.3	502352-0610	6
							14.3	502352-0500	5							14.3	502352-0510	5
							12.3	502352-0400	4							12.3	502352-0410	4
		/	29.4	25.4	24	11.5	10.3	502352-0300	3		/	29.4	25.4	24	11.5	10.3	502352-0310	3
							8.3	502352-0200	2							8.3	502352-0210	2
							PLATING COLOR									F	E	D

C	Sn BLACK	52.4	61.4	57.4	56	26.2	34.3	502352-1501	15	Sn RED	/	/	/	/	/	/	/	15
							32.3	502352-1401	14									14
		40.4	49.4	45.4	44	20.2	30.3	502352-1301	13		40.4	49.4	45.4	44	20.2			13
							28.3	502352-1201	12							28.3	502352-1201	12
							26.3	502352-1101	11							26.3	502352-1101	11
							24.3	502352-1001	10							24.3	502352-1001	10
							22.3	502352-0901	9							22.3	502352-0901	9
		28.4	37.4	33.4	32	14.2	20.3	502352-0801	8		28.4	37.4	33.4	32	14.2	20.3	502352-0802	8
							18.3	502352-0701	7							18.3	502352-0701	7
							16.3	502352-0601	6							16.3	502352-0602	6
							14.3	502352-0501	5							14.3	502352-0501	5
							12.3	502352-0401	4							12.3	502352-0402	4
		/	29.4	25.4	24	11.5	10.3	502352-0301	3		/	29.4	25.4	24	11.5	10.3	502352-0302	3
							8.3	502352-0201	2							8.3	502352-0202	2
							PLATING COLOR									F	E	D

THIS DRAWING CONTAINS INFORMATION THAT IS PROPRIETARY TO MOLEX ELECTRONIC TECHNOLOGIES, LLC AND SHOULD NOT BE USED WITHOUT WRITTEN PERMISSION

DIMENSION UNITS mm	SCALE NTS	CURRENT REV DESC:	
GENERAL TOLERANCES (UNLESS SPECIFIED)		molex	
ANGULAR TOL ±	°	2.0MM PITCH W/B CONN. WAFER ASSY EMBOSSED TAPE PACKAGE	
4 PLACES ±		PRODUCT CUSTOMER DRAWING	
3 PLACES ±		DOCUMENT NUMBER SD-502352-002	
2 PLACES ±		DOC TYPE PSD	DOC PART 001
1 PLACE ±		REVISION K2	
0 PLACES ±		SHEET NUMBER 2 OF 2	

EC NO: 629663  
DRWN: MSATO08 2019/12/26  
CHK'D: HIJIMA 2019/12/27  
APPR: TOSADA 2019/12/27

INITIAL REVISION:  
DRWN: SHSHIBATA 2007/06/06  
CHECK: TAITO 2007/06/06  
APPR: MAYAMAMOTO 2012/03/14

THIRD ANGLE PROJECTION  
DRAWING: A3-SIZE  
SERIES: 502352  
MATERIAL NUMBER: SEE CHART  
CUSTOMER: GENERAL MARKET