

ORDER NO.	WOODHEAD NO.	COLOR
130147-0157	68W47	YELLOW

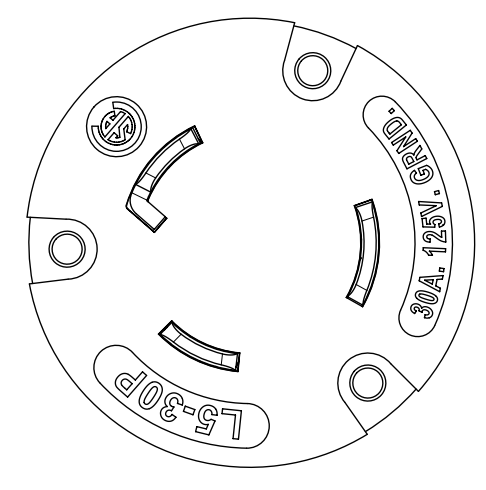

FACE VIEW

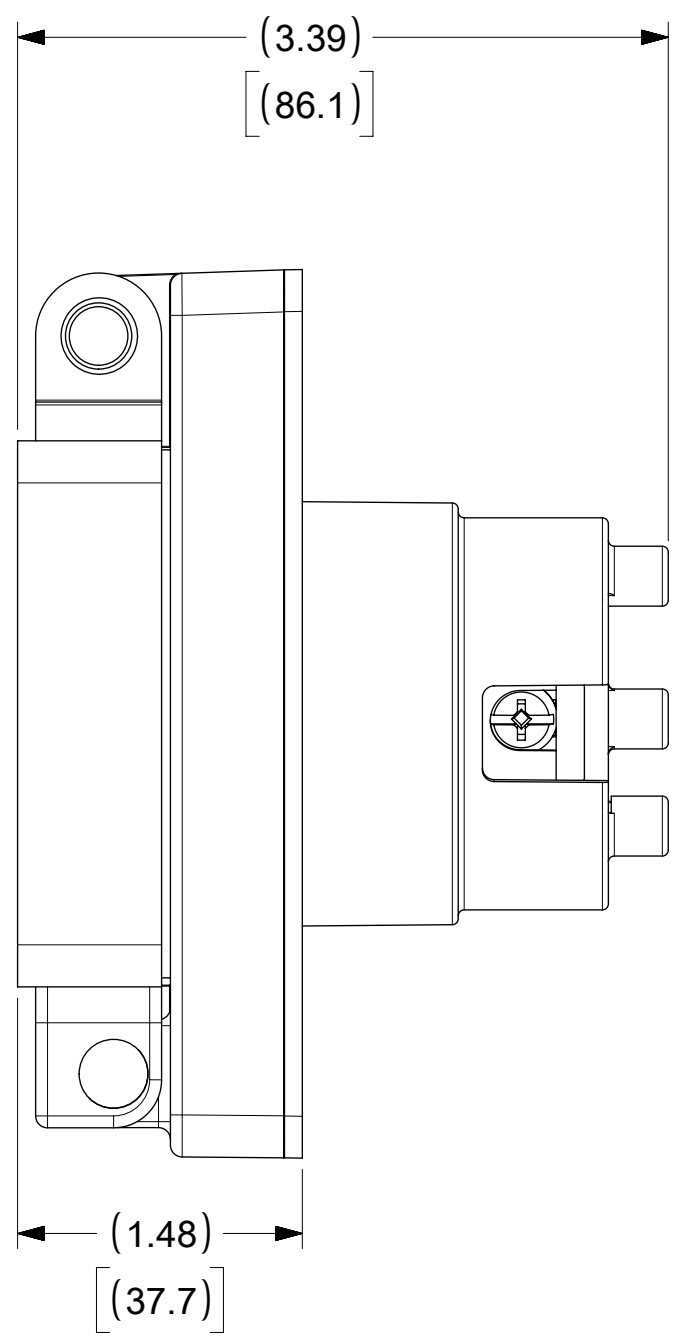
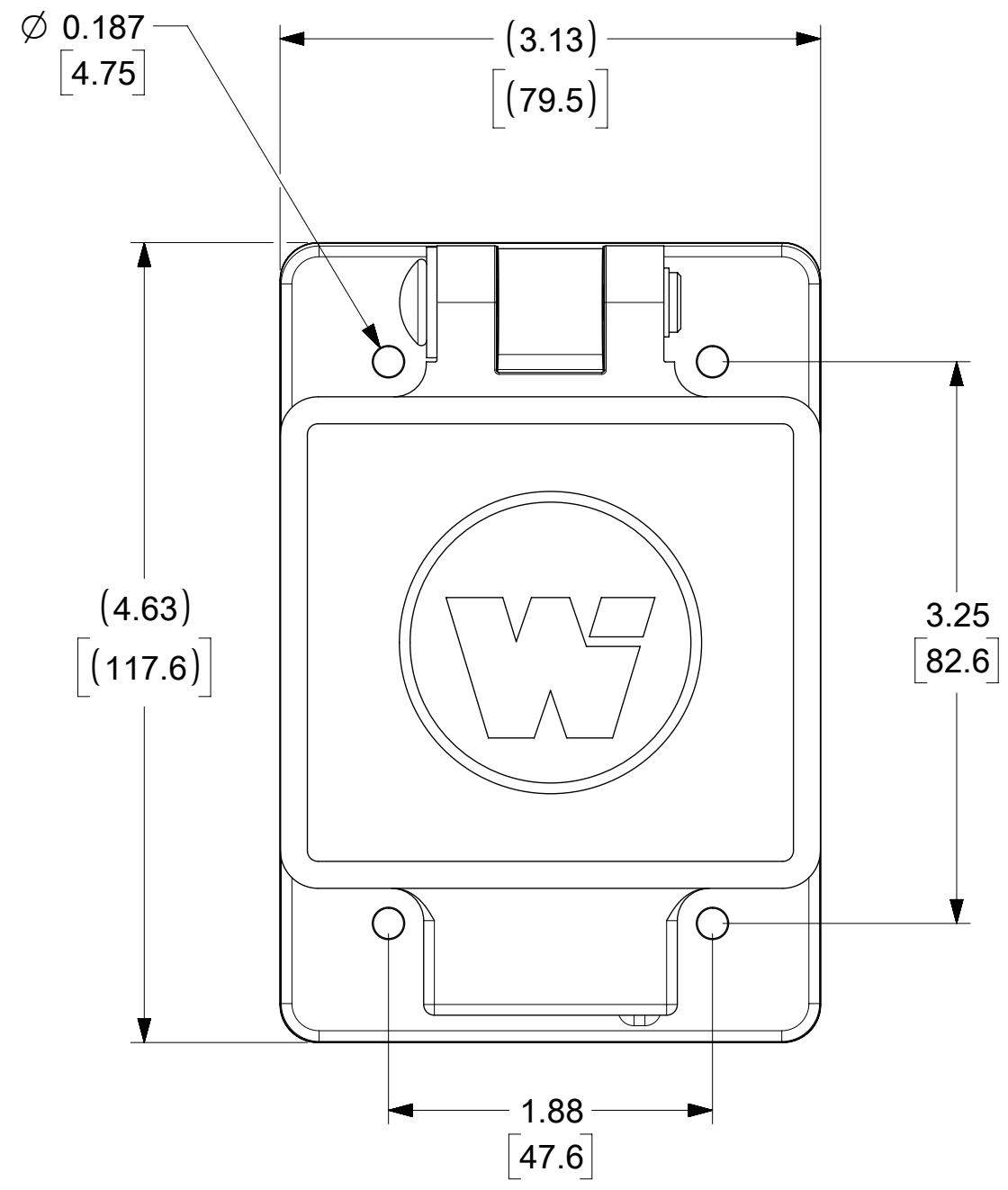
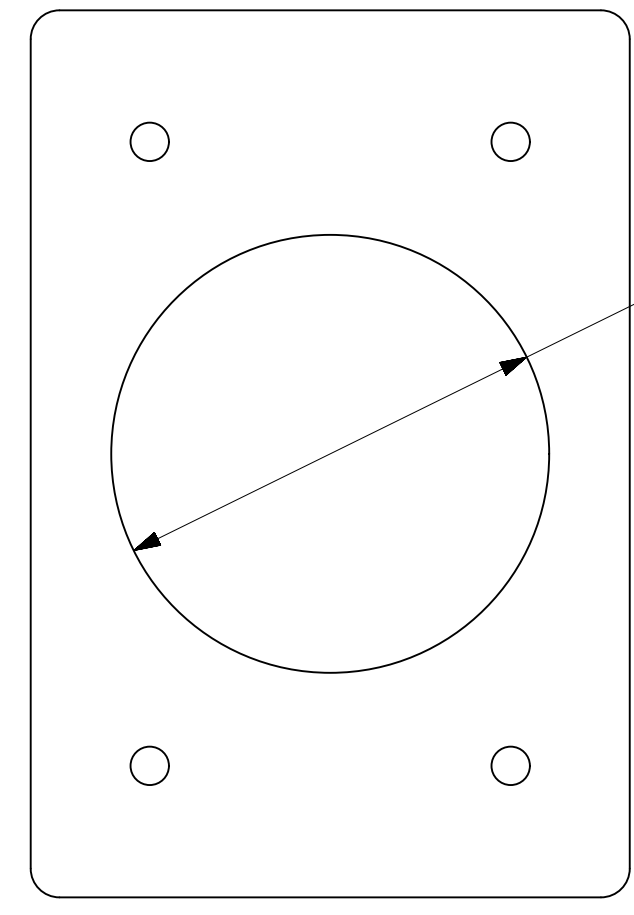
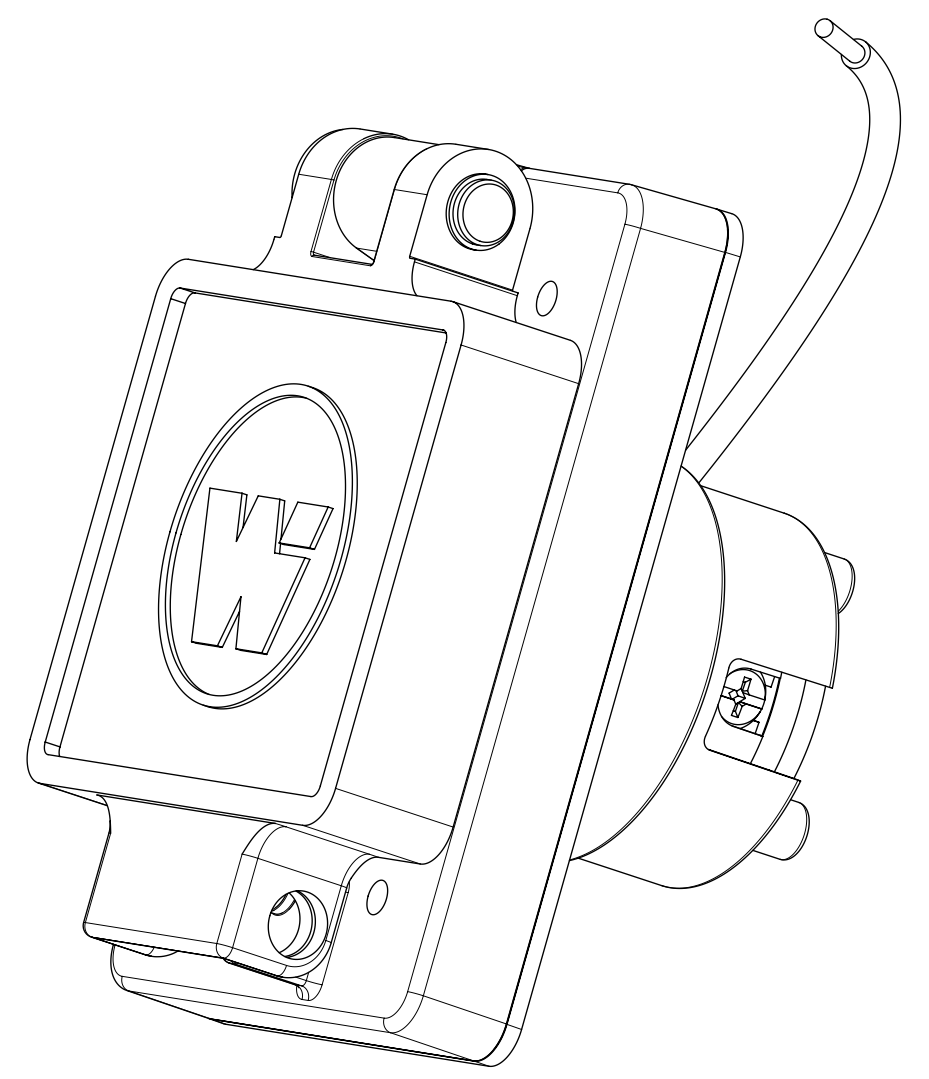

CLEARANCE HOLE (FOR PANEL MOUNT)

DESCRPTION	MATERIAL	QTY.
BLADES	BRASS, NICKEL PLATED	3
RETAINING SCREWS	STAINLESS STEEL	3
CLAMP AND TERMINAL SCREW ASSY.	BRASS, ZINC PLATED	3
MALE INSERT	NYLON	1
TERMINAL COVER	POLYCARBONATE	1
COVER ASSEMBLY	POLYCARBONATE, STAINLESS STEEL, ALUMINUM	1
GASKET FLIP	NEOPRENE	1
MOTOR BASE MTG ASSY	POLYCARBONATE, STAINLESS STEEL, BRASS	1
SCREW (GROUND WIRE)	STAINLESS STEEL	1
JUMPER WIRE ASSY	COPPER, BRASS (TINNED FINISH)	1

THIS DRAWING CONTAINS INFORMATION THAT IS PROPRIETARY TO MOLEX ELECTRONIC TECHNOLOGIES, LLC AND SHOULD NOT BE USED WITHOUT WRITTEN PERMISSION									
SYMBOLS		DIMENSION UNITS		SCALE		CURRENT REV DESC: MIGRATE TO ECTR/NX			
= 0		INCH[MM]		NTS		molex WATERTITE MOTOR BASE COVERPLATE 2P3W L5-30			
= 0		GENERAL TOLERANCES (UNLESS SPECIFIED)							
= 0		MM		INCH		EC NO: 613925 DRWN: SRPATIL 2018/12/21 CHK'D: DNGUYEN62 2019/03/19 APPR: HKNEELAND 2019/04/02			
= 0		4 PLACES ±		±		PRODUCT CUSTOMER DRAWING DOCUMENT NUMBER: 1301470157 DOC TYPE: PSD DOC PART: 000 REVISION: A			
= 0		3 PLACES ±		±					
= 0		2 PLACES ±		±		INITIAL REVISION: DRWN: SRPATIL 2018/12/21 APPR: HKNEELAND 2019/04/02			
= 0		1 PLACE ±		±					
= 0		0 PLACES ±		±		MATERIAL NUMBER: SEE TABLE CUSTOMER: GENERAL MARKET SHEET NUMBER: 1 OF 1			
= 0		ANGULAR TOL ± °		°					
= 0		DRAFT WHERE APPLICABLE MUST REMAIN WITHIN DIMENSIONS		THIRD ANGLE PROJECTION		DRAWING SERIES		C-SIZE 130147	