

ORDER NO.	WOODHEAD NO.	COLOR
130142-0047	2981	YELLOW

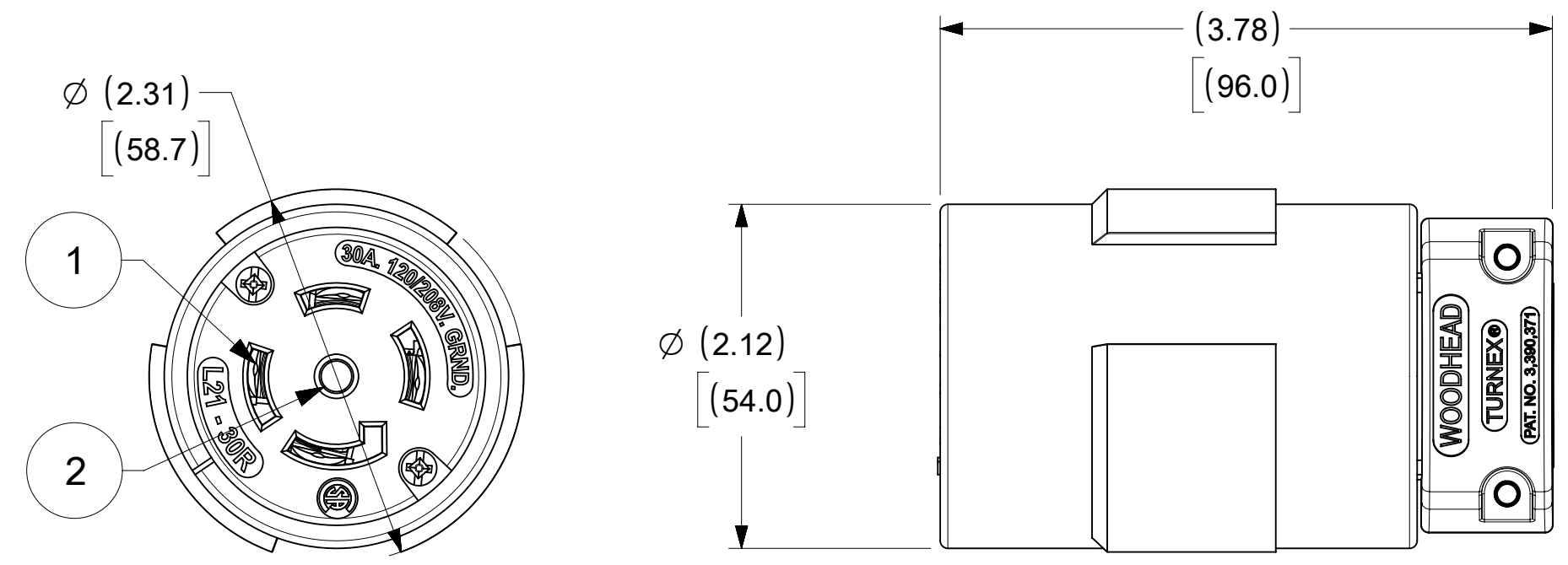

WIRING TERMINATION

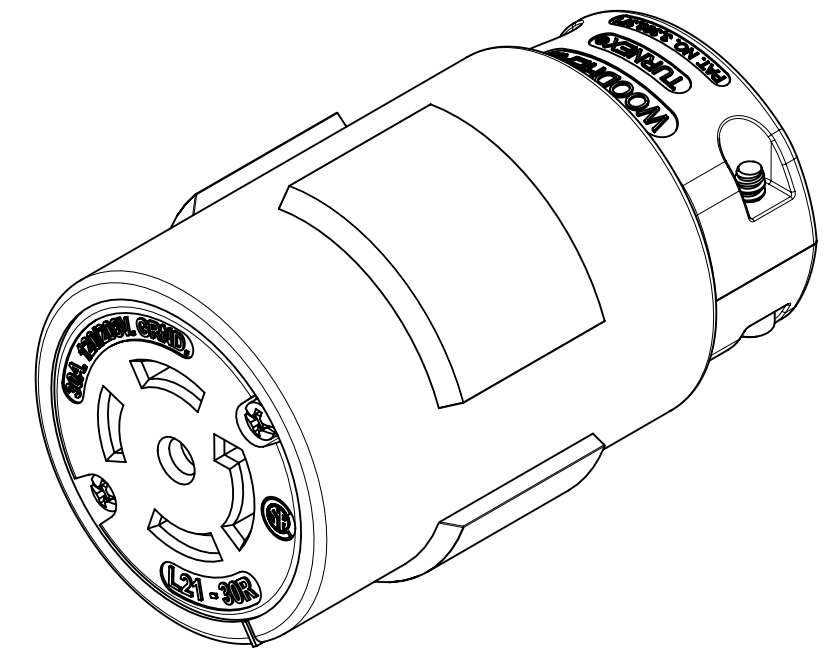
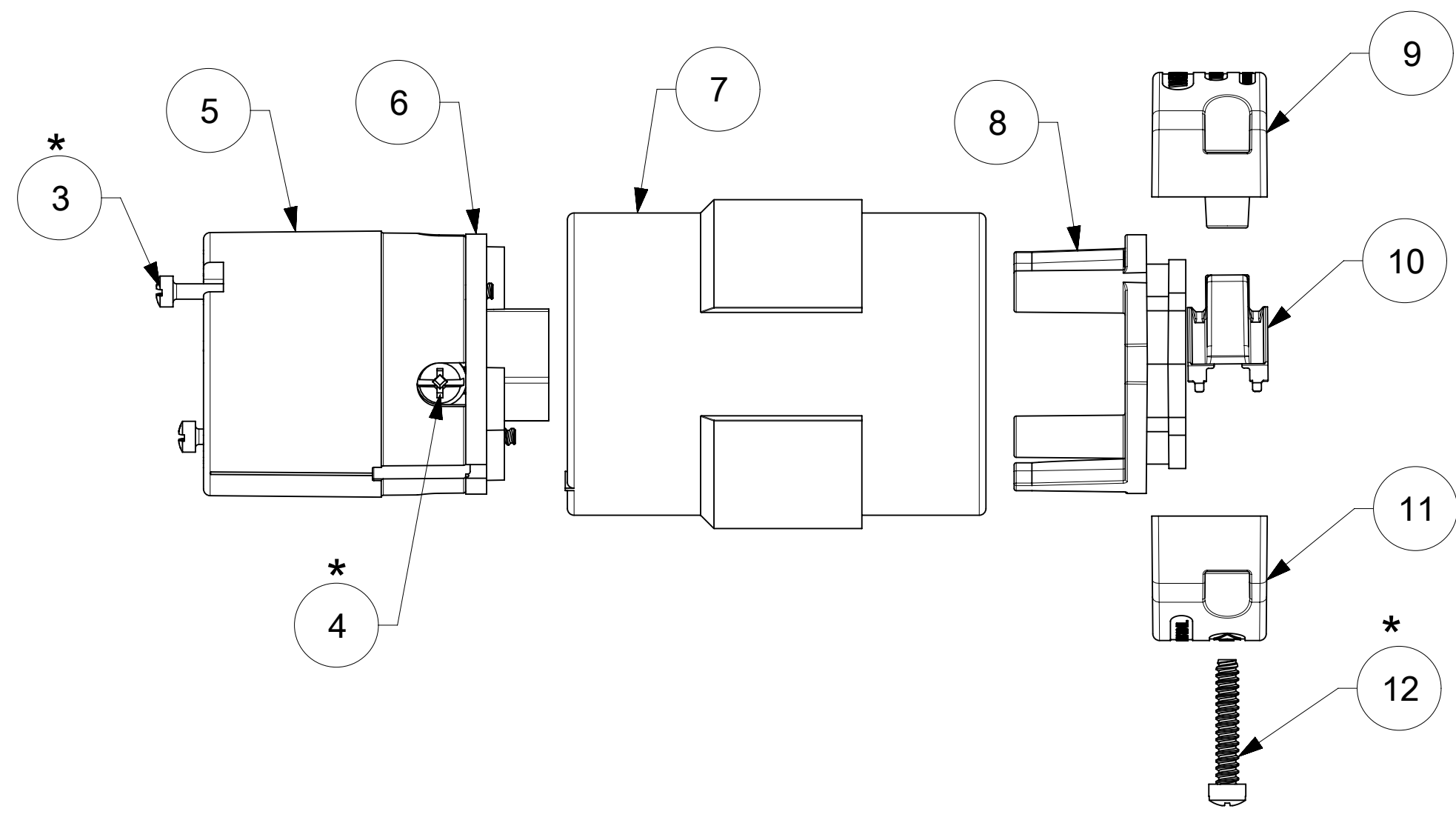
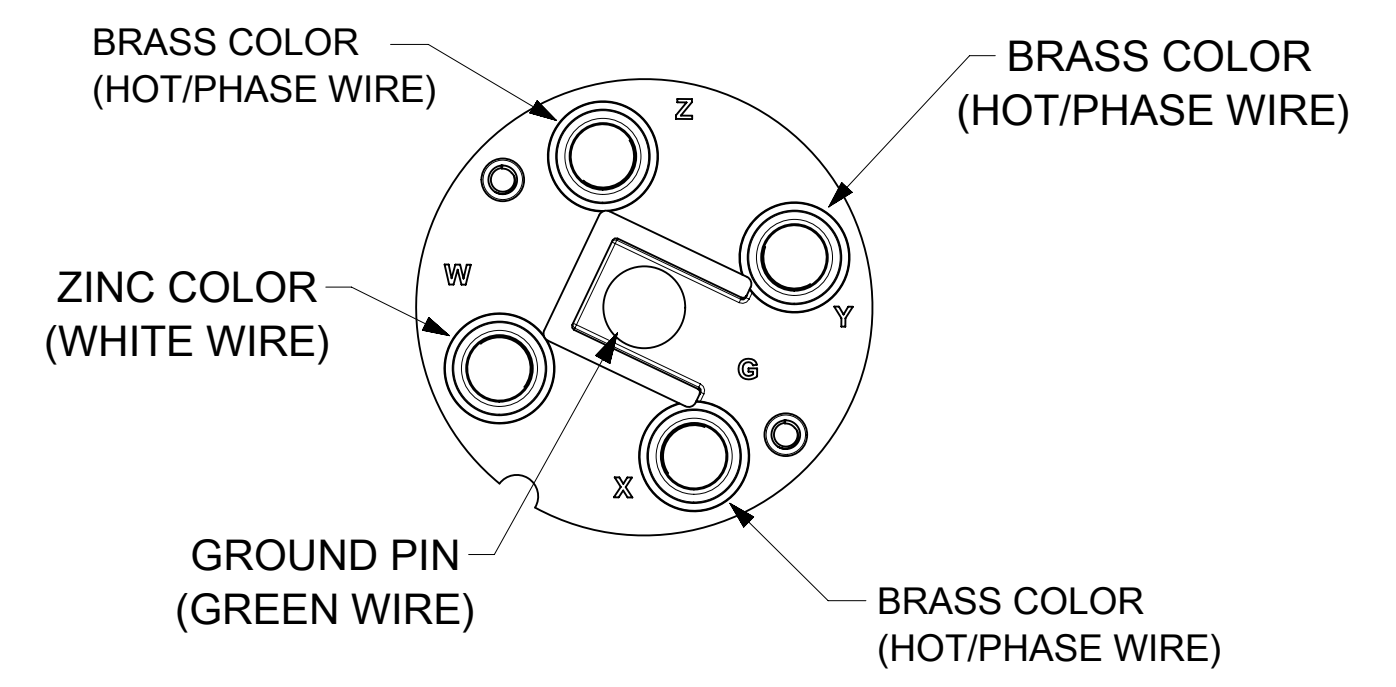

* FOR SCREW TORQUE, SEE ASSEMBLY INSTRUCTIONS

ITEM NO.	DESCRIPTIONS	MATERIAL	QTY.
1	CLIP ASSEMBLY	BRASS, NICKEL PLATED	4
2	GROUND SOCKET	BRASS	1
3	RETAINING SCREWS	STAINLESS STEEL	2
4	TERMINAL SCREWS/CLAMP ASSEMBLY	BRASS, ZINC PLATED	4
5	INSERT	NYLON	1
6	TERMINAL COVER	POLYCARBONATE	1
7	CONNECTOR HUSK	RUBBER	1
8	CLAMP SUPPORT	NYLON	1
9	CLAMP CORD MALE	NYLON	1
10	CLAMP CORD INSERT	NYLON	1
11	CLAMP CORD FEMALE	NYLON	1
12	RETAINING SCREWS	STEEL	2









SYMBOLS		THIS DRAWING CONTAINS INFORMATION THAT IS PROPRIETARY TO MOLEX ELECTRONIC TECHNOLOGIES, LLC AND SHOULD NOT BE USED WITHOUT WRITTEN PERMISSION	
▽ = 0	INCH/MM	SCALE	CURRENT REV DESC: NEW RELEASE
▽ = 0	NTS		
▽ = 0	GENERAL TOLERANCES (UNLESS SPECIFIED)		EC NO: 627957 DRWN: VHANDI 2020/01/16 CHK'D: DNGUYEN62 2020/02/21 APPR: HKNEELAND 2020/06/02
▽ = 0	4 PLACES ±	MM INCH	
▽ = 0	3 PLACES ±		INITIAL REVISION: DRWN: VHANDI 2019/06/10 APPR: HKNEELAND 2020/06/02
▽ = 0	2 PLACES ±		
▽ = 0	1 PLACE ±		THIRD ANGLE PROJECTION
▽ = 0	0 PLACES ±		
▽ = 0	ANGULAR TOL ± °		DRAWING SERIES
▽ = 0	DRAFT WHERE APPLICABLE MUST REMAIN WITHIN DIMENSIONS		C-SIZE 130142

molex			
SUPER-SAFEWAY CONN NEMA 4P5W L21-30R			
PRODUCT CUSTOMER DRAWING			
DOCUMENT NUMBER	DOC TYPE	DOC PART	REVISION
1301420047	PSD	000	A1
MATERIAL NUMBER	CUSTOMER	SHEET NUMBER	
SEE TABLE	GENERAL MARKET	1 OF 2	

12 11 10 9 8 7 6 5 4 3 2 1

H
G
F
E
D
C
B
A

H
G
F
E
D
C
B
A

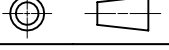
SYMBOLS	THIS DRAWING CONTAINS INFORMATION THAT IS PROPRIETARY TO MOLEX ELECTRONIC TECHNOLOGIES, LLC AND SHOULD NOT BE USED WITHOUT WRITTEN PERMISSION												
	DIMENSION UNITS	SCALE	CURRENT REV DESC:							molex			
	 = 0	INCH/MM	NTS										
	 = 0	GENERAL TOLERANCES (UNLESS SPECIFIED)		EC NO: 627957							SUPER-SAFEWAY CONN NEMA 4P5W L21-30R		
	 = 0	ANGULAR TOL	± °	DRWN: VHANDI				2020/01/16					
	 = 0	4 PLACES	±	CHK'D: DNGUYEN62				2020/02/21					
	 = 0	3 PLACES	±	APPR: HKNEELAND				2020/06/02		PRODUCT CUSTOMER DRAWING			
	 = 0	2 PLACES	±	INITIAL REVISION:									
	 = 0	1 PLACE	±	DRWN: VHANDI				2019/06/10		DOCUMENT NUMBER	DOC TYPE	DOC PART	REVISION
	 = 0	0 PLACES	±	APPR: HKNEELAND				2020/06/02		1301420047	PSD	000	A1
 = 0	DRAFT WHERE APPLICABLE MUST REMAIN WITHIN DIMENSIONS		THIRD ANGLE PROJECTION	DRAWING	SERIES	MATERIAL NUMBER	CUSTOMER	SHEET NUMBER					
= 0				C-SIZE	130142		GENERAL MARKET	2 OF 2					

DOCUMENT STATUS	P1	RELEASE DATE	2020/06/02	03:25:15
-----------------	----	--------------	------------	----------

12 11 10 9 8 7 6 5 4 3 2 1

FORMATS: moxletr-01-prod-c
REVISION: 11
DATE: 2019/01/15