

CKT	A	B
2	3.85	NA
4	6.85	3
6	9.85	6
8	12.85	9
10	15.85	12
12	18.85	15
14	21.85	18
16	24.85	21
18	27.85	24
20	30.85	27
22	33.85	30
24	36.85	33

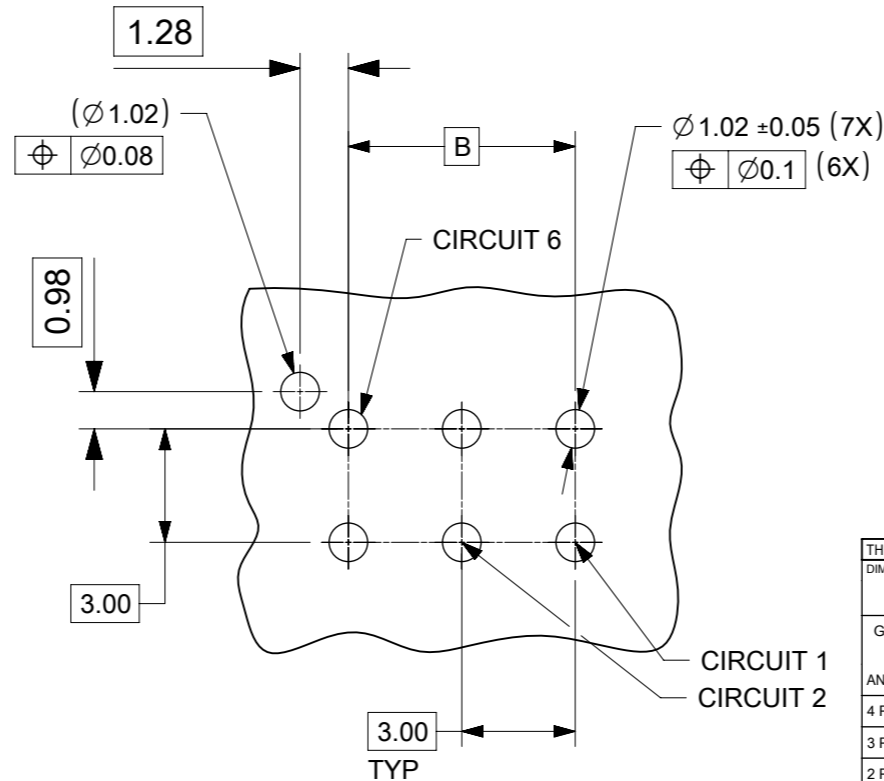
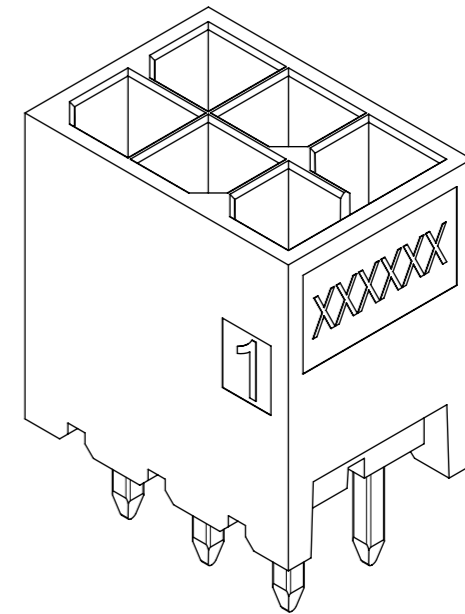
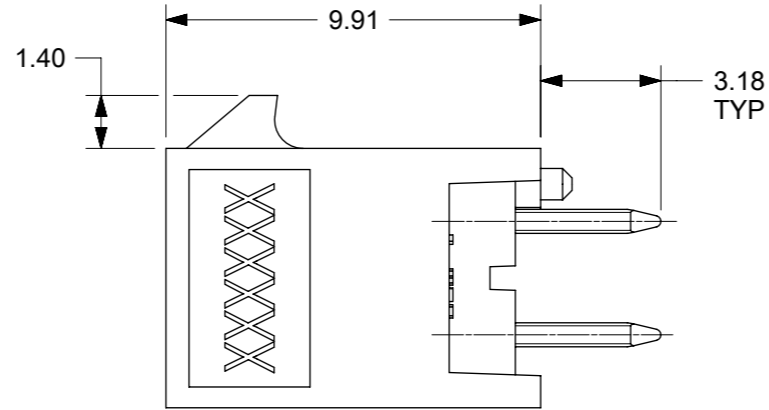
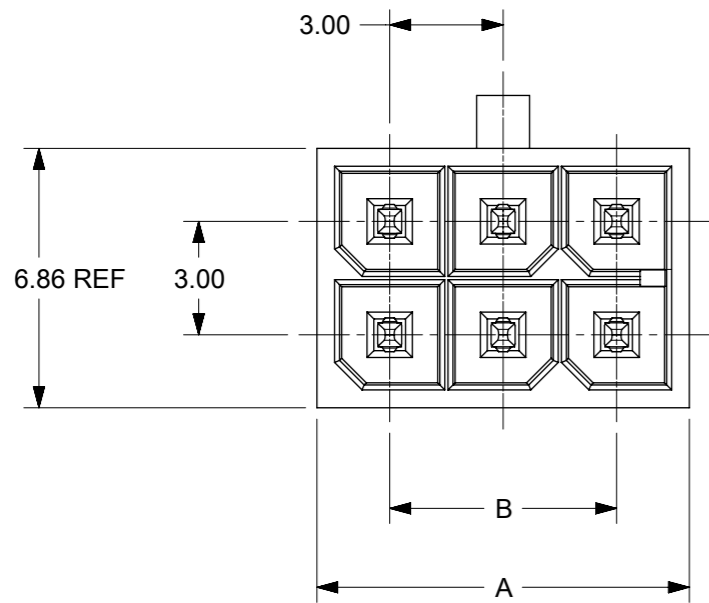
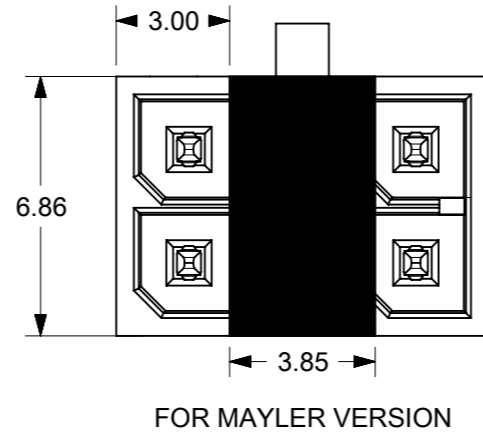
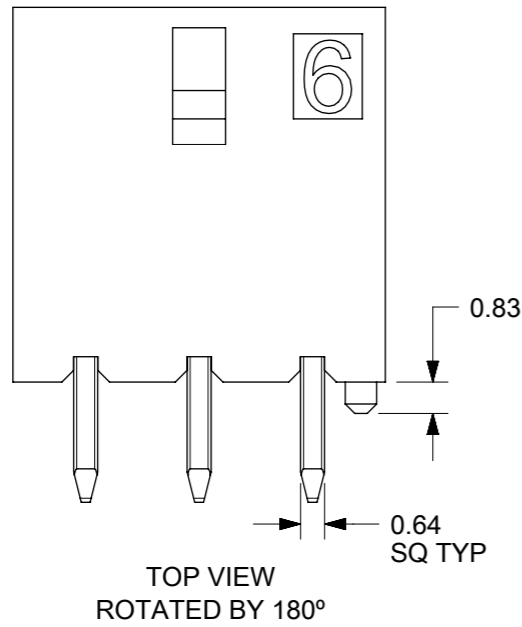

PCB LAYOUT: COMPONENT SIDE
RECOMENDED PCB THICKNESS: .062/1.57 Max.

NOTES:

- HOSING MATERIAL: GLASS FILLED LIQUID CRYSTAL POLYMER, UL 94V-0, COLOR: BLACK
TERMINAL MATERIAL: HIGH COPPER ALLOY
- FINISH:
OPTION 1: TIN OVER NICKEL OVERALL
OPTION 2: SELECT 15MICROINCH GOLD AND SELECT MATTE TIN OVER NICKEL.
OPTION 3: SELECT 30MICROINCH GOLD AND SELECT MATTE TIN OVER NICKEL.
- PRODUCT SPECIFICATION : 2064600000-PS
- TRAY PACK : 2068320000-PK
TAPE REEL PACK : 2068320001-PK
- MATE WITH RECEPTACLE 206461
- THIS PART CONFORMS TO CLASS 'B' REQUIREMENTS OF COSMETIC SPECIFICATION PS-45499-002.

DIMENSION UNITS		SCALE	CURRENT REV DESC:							
mm		5:1								
GENERAL TOLERANCES (UNLESS SPECIFIED)			<p>molex</p> <p>V HDR ASSY BANDO MICRO-FIT + SOLUTION</p> <p>PRODUCT CUSTOMER DRAWING</p>							
ANGULAR TOL \pm 0.5°										
4 PLACES \pm										
3 PLACES \pm										
2 PLACES \pm 0.25										
1 PLACE \pm 0.36										
0 PLACES \pm			<p>INITIAL REVISION:</p> <p>DRWN: SMAHAJANSHET 2018/05/08</p> <p>APPR: NCSR 2019/04/02</p>							
DRAFT WHERE APPLICABLE MUST REMAIN WITHIN DIMENSIONS		THIRD ANGLE PROJECTION	DRAWING	SERIES	MATERIAL NUMBER	CUSTOMER	DOCUMENT NUMBER	DOC TYPE	DOC PART	REVISION
			A3-SIZE	206832	SEE TABLE	GENERAL MARKET	2068320000-SD	PSD	000	C
SHEET NUMBER		1 OF 4								

TIN PLATING				30 MICROINCH GOLD				15 MICROINCH GOLD				TIN PLATING					
TRAY PACKAGING -2068320000-PK				TRAY PACKAGING -2068320000-PK				TRAY PACKAGING -2068320000-PK				T&R PACKAGING -2068320001-PK					
CKT	VRT HDR ASSY PN	POLARIZATION	COLOR	CKT	VRT HDR ASSY PN	POLARIZATION	COLOR	CKT	VRT HDR ASSY PN	POLARIZATION	COLOR	CKT	VRT HDR ASSY PN	POLARIZATION	COLOR		
F	2068320201	A	BLACK	2	2068320203	A	BLACK	2	2068320202	A	BLACK	A	2	206832-0221	BLACK		
	2242460210	B	NATURAL		2242460212	B	NATURAL		2242460211	B	NATURAL		4	206832-0421			
	2242460220	C	RED		2242460222	C	RED		2242460221	C	RED		6	206832-0621			
	2242460230	D	BLUE		2242460232	D	BLUE		2242460231	D	BLUE		8	206832-0821			
	2242460240	E	YELLOW		2242460242	E	YELLOW		2242460241	E	YELLOW		10	206832-1021			
4	2068320401	A	BLACK	4	2068320403	A	BLACK	4	2068320402	A	BLACK		12	206832-1221			
	2242460410	B	NATURAL		2242460412	B	NATURAL		2242460411	B	NATURAL		14	206832-1421			
	2242460420	C	RED		2242460422	C	RED		2242460421	C	RED		16	206832-1621			
	2242460430	D	BLUE		2242460432	D	BLUE		2242460431	D	BLUE		18	206832-1821			
	2242460440	E	YELLOW		2242460442	E	YELLOW		2242460441	E	YELLOW		20	206832-2021			
E	2068320601	A	BLACK	6	2068320603	A	BLACK	6	2068320602	A	BLACK		22	206832-2221			
	2242460610	B	NATURAL		2242460612	B	NATURAL		2242460611	B	NATURAL		24	206832-2421			
	2242460620	C	RED		2242460622	C	RED		2242460621	C	RED		15 MICROINCH GOLD				
	2242460630	D	BLUE		2242460632	D	BLUE		2242460631	D	BLUE		T&R PACKAGING -2068320001-PK				
	2242460640	E	YELLOW		2242460642	E	YELLOW		2242460641	E	YELLOW		CKT	VRT HDR ASSY PN		POLARIZATION	COLOR
8	2068320801	A	BLACK	8	2068320803	A	BLACK	8	2068320802	A	BLACK		2	206832-0222		A	BLACK
	2242460810	B	NATURAL		2242460812	B	NATURAL		2242460811	B	NATURAL		4	206832-0422			
	2242460820	C	RED		2242460822	C	RED		2242460821	C	RED		6	206832-0622			
	2242460830	D	BLUE		2242460832	D	BLUE		2242460831	D	BLUE		8	206832-0822			
	2242460840	E	YELLOW		2242460842	E	YELLOW		2242460841	E	YELLOW		10	206832-1022			
D	2068321001	A	BLACK	10	2068321003	A	BLACK	10	2068321002	A	BLACK		12	206832-1222			
	2242461010	B	NATURAL		2242461012	B	NATURAL		2242461011	B	NATURAL		14	206832-1422			
	2242461020	C	RED		2242461022	C	RED		2242461021	C	RED		16	206832-1622			
	2242461030	D	BLUE		2242461032	D	BLUE		2242461031	D	BLUE		18	206832-1822			
	2242461040	E	YELLOW		2242461042	E	YELLOW		2242461041	E	YELLOW	20	206832-2022				
12	2068321201	A	BLACK	12	2068321203	A	BLACK	12	2068321202	A	BLACK	22	206832-2222				
	2242461210	B	NATURAL		2242461212	B	NATURAL		2242461211	B	NATURAL	24	206832-2422				
	2242461220	C	RED		2242461222	C	RED		2242461221	C	RED	30 MICROINCH GOLD					
	2242461230	D	BLUE		2242461232	D	BLUE		2242461231	D	BLUE	T&R PACKAGING -2068320001-PK					
	2242461240	E	YELLOW		2242461242	E	YELLOW		2242461241	E	YELLOW	CKT	VRT HDR ASSY PN	POLARIZATION	COLOR		
C	2068321401	A	BLACK	14	2068321403	A	BLACK	14	2068321402	A	BLACK	2	206832-0223	A	BLACK		
	2068321601	A	BLACK		2068321603	A	BLACK		2068321602	A	BLACK	4	206832-0423				
	2068321801	A	BLACK		2068321803	A	BLACK		2068321802	A	BLACK	6	206832-0623				
	2068322001	A	BLACK		2068322003	A	BLACK		2068322002	A	BLACK	8	206832-0823				
	2068322201	A	BLACK		2068322203	A	BLACK		2068322202	A	BLACK	10	206832-1023				
24	206832-2401	A	BLACK	24	206832-2403	A	BLACK	24	2068322402	A	BLACK	12	206832-1223				
												14	206832-1423				
												16	206832-1623				
												18	206832-1823				
												20	206832-2023				
										22	206832-2223						
										24	206832-2423						

THIS DRAWING CONTAINS INFORMATION THAT IS PROPRIETARY TO MOLEX ELECTRONIC TECHNOLOGIES, LLC AND SHOULD NOT BE USED WITHOUT WRITTEN PERMISSION		CURRENT REV DESC:		molex	
DIMENSION UNITS	SCALE	EC NO: 760703			
mm	1:1	DRWN: VENKASS 2023/03/30		V HDR ASSY BANDO MICRO-FIT + SOLUTION	
GENERAL TOLERANCES (UNLESS SPECIFIED)		CHK'D: VENKASS 2023/08/24			
ANGULAR TOL	± 0.5°	APPR: MRAMAKRISHNA 2023/08/24		PRODUCT CUSTOMER DRAWING	
4 PLACES	±	INITIAL REVISION:		DOCUMENT NUMBER	
3 PLACES	±	DRWN: SMAHAJANSHET 2018/05/08		2068320000-SD	
2 PLACES	± 0.25	APPR: NCSR 2019/04/02		DOC TYPE	DOC PART
1 PLACE	± 0.36	THIRD ANGLE PROJECTION		PSD	000
0 PLACES	±	DRAWING		REVISION	C
DRAFT WHERE APPLICABLE MUST REMAIN WITHIN DIMENSIONS		A3-SIZE	SERIES	MATERIAL NUMBER	CUSTOMER
			206832	SEE TABLE	GENERAL MARKET
				SHEET NUMBER	
				2 OF 4	

9 8 7 6 5 4 3 2 1

CKT	POLARIZATION "A"- BLACK	POLARIZATION "B"- NATURAL	POLARIZATION "C" - RED	POLARIZATION "D" - BLUE	POLARIZATION "E" - YELLOW
2					
4					
6					
8					
10					
12					

Ⓒ

SYMBOLS = 0 = 0 = 0 = 0 = 0 = 0 = 0 = 0 = 0 = 0	THIS DRAWING CONTAINS INFORMATION THAT IS PROPRIETARY TO MOLEX ELECTRONIC TECHNOLOGIES, LLC AND SHOULD NOT BE USED WITHOUT WRITTEN PERMISSION DIMENSION UNITS: mm SCALE: 1:1	CURRENT REV DESC: EC NO: 760703 DRWN: VENKAS5 2023/03/30 CHK'D: VENKAS5 2023/08/24 APPR: MRAMAKRISHNA 2023/08/24	 V HDR ASSY BANDO MICRO-FIT + SOLUTION		
	GENERAL TOLERANCES (UNLESS SPECIFIED) ANGULAR TOL ± 0.5° 4 PLACES ± 3 PLACES ± 2 PLACES ± 0.13 1 PLACE ± 0.25 0 PLACES ±	INITIAL REVISION: DRWN: SMAHAJANSHET 2018/05/08 APPR: NCSR 2019/04/02			
	DRAFT WHERE APPLICABLE MUST REMAIN WITHIN DIMENSIONS THIRD ANGLE PROJECTION DRAWING: A3-SIZE SERIES: 206832	MATERIAL NUMBER: SEE TABLE CUSTOMER: GENERAL MARKET	DOCUMENT NUMBER: 2068320000-SD DOC TYPE: PSD DOC PART: 000 REVISION: C	SHEET NUMBER: 3 OF 4	

9 8 7 6 5 4 3 2 1

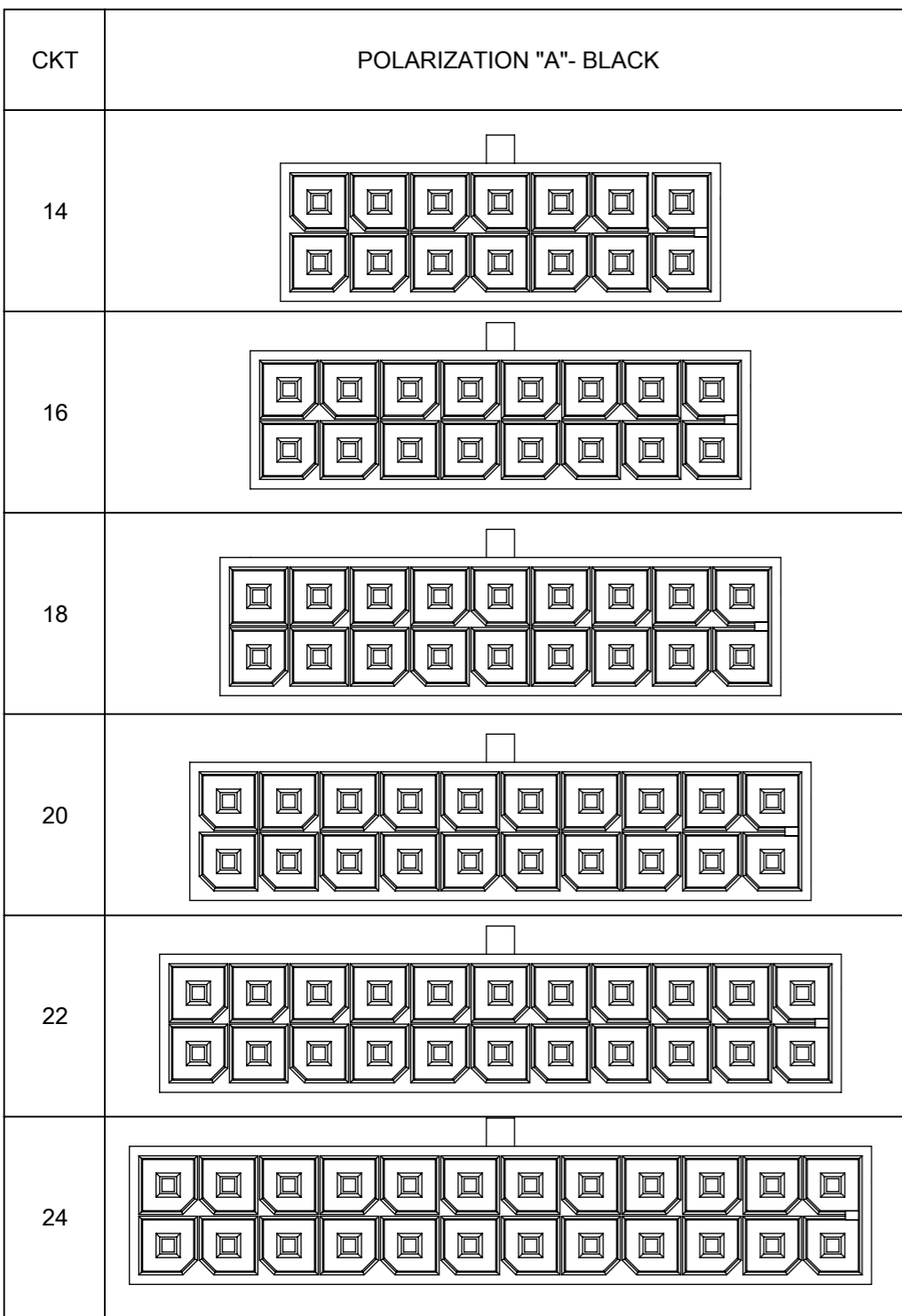

FUNCTIONAL SYMBOLS	THIS DRAWING CONTAINS INFORMATION THAT IS PROPRIETARY TO MOLEX ELECTRONIC TECHNOLOGIES, LLC AND SHOULD NOT BE USED WITHOUT WRITTEN PERMISSION		CURRENT REV DESC:					
	$\nabla_A = 0$ $\nabla_F = 0$ $\nabla_V = 0$	DIMENSION UNITS mm						
DIVISIONAL SYMBOLS	4 PLACES	\pm	EC NO: 760703	2023/03/30	V HDR ASSY BANDO MICRO-FIT + SOLUTION PRODUCT CUSTOMER DRAWING			
	3 PLACES	\pm	DRWN: VENKAS5	2023/08/24				
	2 PLACES	± 0.13	CHK'D: VENKAS5	2023/08/24	DOCUMENT NUMBER	DOC TYPE	DOC PART	REVISION
	1 PLACE	± 0.25	APPR: MRAMAKRISHNA	2023/08/24	2068320000-SD	PSD	000	C
	0 PLACES	\pm	INITIAL REVISION: DRWN: SMAHAJANSHET APPR: NCSR	2018/05/08 2019/04/02				
DRAFT WHERE APPLICABLE MUST REMAIN WITHIN DIMENSIONS		THIRD ANGLE PROJECTION	DRAWING	SERIES	MATERIAL NUMBER	CUSTOMER	SHEET NUMBER	
			A3-SIZE	206832		GENERAL MARKET	4 OF 4	