

# TLV761 16V, 1A, Fixed Output Linear Voltage Regulator

## 1 Features

- Pin-compatible with industry-standard [LM1117](#) and [TLV1117](#) (x1117) devices in select packages
- Input voltage range  $V_{IN}$ : 2.5V to 16V (abs max rating of 20V)
- Output voltage range  $V_{OUT}$ :
  - 0.8V to 13V (fixed, 100mV steps)
- Output current: Up to 1A
- Low quiescent current  $I_Q$ :
  - 60 $\mu$ A (typical, ~1.5 $\mu$ A in shutdown)
- 1% output accuracy over line, load and temperature
- High PSRR: 60dB at 1kHz, 40dB at 1MHz
- Internal soft-start time: 500 $\mu$ s (typical)
- Foldback current limiting and thermal protection
- Stable with 1 $\mu$ F ceramic output capacitors
- Temperature range: –40°C to +125°C
- Packages:
  - 4-pin, 6.5mm × 7mm SOT-223
  - 3-pin, 6.6mm × 10.11mm TO-252 (preview)

## 2 Applications

- [Appliances](#)
- [Home theater and entertainment](#)
- [Motor drives](#)
- [HVAC and building security systems](#)
- [Smart meters](#)

## 3 Description

The TLV761 is a linear voltage regulator that improves the functionality of a traditional x1117 regulator (TLV1117 or LM1117) with tighter output accuracy and low quiescent current ( $I_Q$ ) to lower the standby power consumption. The TLV761 is pin-to-pin compatible with other fixed SOT-223, TO-252 regulators.

The TLV761 input voltage range is from 2.5V to 16V and provides an output voltage range from 0.8V to 13V to support a wide variety of applications.

The wide bandwidth PSRR performance of the TLV761 is typically greater than 60dB at 1kHz and 40dB at 1MHz, which helps attenuate the switching frequency of an upstream DC/DC converter and minimizes post regulator filtering.

Additionally, the TLV761 has an internal soft start feature to reduce inrush current during start-up, which can help save space and cost in a design by minimizing input capacitance. The TLV761 features a foldback current limit that limits the power dissipation of the device during high-load current faults or shorting events.

### Package Information

PART NUMBER	PACKAGE <sup>(1)</sup>	PACKAGE SIZE <sup>(2)</sup>
TLV761	DCY (SOT-223, 4)	6.5mm × 7mm
	KVU (TO-252, 3) <sup>(3)</sup>	6.6mm × 10.11mm

- (1) For all available packages, see the orderable addendum at the end of the data sheet.
- (2) The package size (length × width) is a nominal value and includes pins, where applicable.
- (3) Preview information (not Production Data).

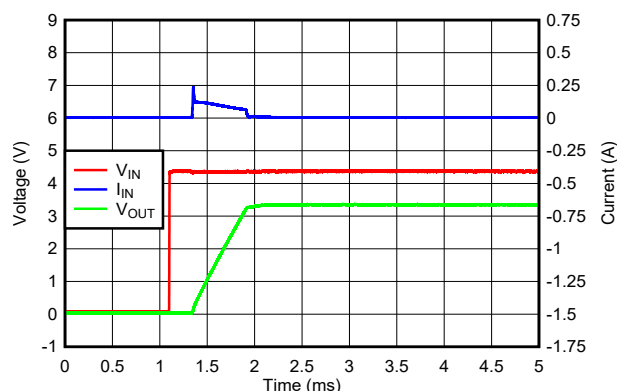

Inrush Current With 22 $\mu$ F at  $C_{OUT}$

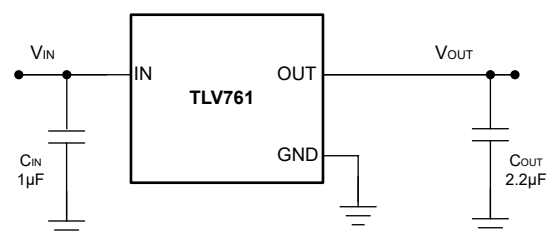

Typical Application Circuit



## Table of Contents

<b>1 Features</b> .....	1	7.1 Application Information.....	13
<b>2 Applications</b> .....	1	7.2 Typical Application.....	15
<b>3 Description</b> .....	1	7.3 Best Design Practices.....	16
<b>4 Pin Configuration and Functions</b> .....	3	7.4 Power Supply Recommendations.....	16
<b>5 Specifications</b> .....	4	7.5 Layout.....	17
5.1 Absolute Maximum Ratings.....	4	<b>8 Device and Documentation Support</b> .....	18
5.2 ESD Ratings.....	4	8.1 Device Support.....	18
5.3 Recommended Operating Conditions.....	4	8.2 Documentation Support.....	18
5.4 Thermal Information.....	5	8.3 Receiving Notification of Documentation Updates....	18
5.5 Electrical Characteristics.....	5	8.4 Support Resources.....	18
5.6 Typical Characteristics.....	6	8.5 Trademarks.....	18
<b>6 Detailed Description</b> .....	10	8.6 Electrostatic Discharge Caution.....	18
6.1 Overview.....	10	8.7 Glossary.....	18
6.2 Functional Block Diagram.....	10	<b>9 Revision History</b> .....	19
6.3 Feature Description.....	10	<b>10 Mechanical, Packaging, and Orderable Information</b> .....	19
6.4 Device Functional Modes.....	12		
<b>7 Application and Implementation</b> .....	13		

## 4 Pin Configuration and Functions

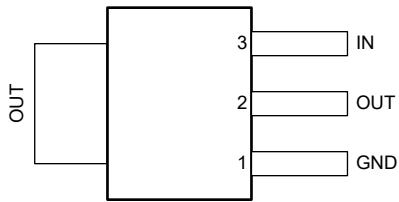

Figure 4-1. DCY Package, 4-Pin SOT-223 (Top View)

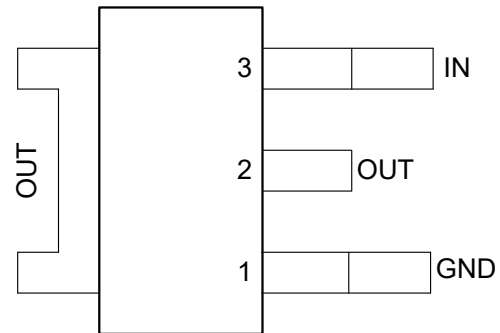

Figure 4-2. KVU Package (Preview), 3-Pin TO-252 (Top View)

Table 4-1. Pin Functions

NAME	PIN		FUNCTION	DESCRIPTION
	DCY	KVU		
GND	1	1	—	Ground pin
OUT	2, Tab	2, Tab	O	Output pin. Use the recommended capacitor value as listed in the <a href="#">Recommended Operating Conditions</a> table. Place the output capacitor as close to the OUT and GND pins of the device as possible.
IN	3	3	I	Input pin. Use the recommended capacitor value as listed in the <a href="#">Recommended Operating Conditions</a> table. Place the input capacitor as close to the IN and GND pins of the device as possible.

## 5 Specifications

### 5.1 Absolute Maximum Ratings

Over operating free-air temperature range (unless otherwise noted)<sup>(1)</sup>

		MIN	MAX	UNIT
Voltage <sup>(2)</sup>	V <sub>IN</sub>	-0.3	20	V
	V <sub>OUT</sub> <sup>(3)</sup>	-0.3	V <sub>IN</sub> + 0.3	
Current	Maximum output current	Internally limited		A
Power	Power dissipation	Package limited <sup>(4)</sup>		W
Temperature	Operating junction (T <sub>J</sub> )	-50	150	°C
	Storage (T <sub>STG</sub> )	-65	150	

- (1) Stresses beyond those listed under *Absolute Maximum Rating* may cause permanent damage to the device. These are stress ratings only, which do not imply functional operation of the device at these or any other conditions beyond those indicated under *Recommended Operating Condition*. Exposure to absolute-maximum-rated conditions for extended periods may affect device reliability.
- (2) All voltages with respect to GND.
- (3) V<sub>IN</sub> + 0.3 V or 18 V (whichever is smaller).
- (4) See thermal information for further details.

### 5.2 ESD Ratings

		VALUE	UNIT
V <sub>(ESD)</sub>	Electrostatic discharge	Human body model (HBM), per ANSI/ESDA/ JEDEC JS-001, all pins <sup>(1)</sup>	±3000
		Charged device model (CDM), per JEDEC specification JESD22-C101, all pins <sup>(2)</sup>	±1000

- (1) JEDEC document JEP155 states that 500-V HBM allows safe manufacturing with a standard ESD control process.
- (2) JEDEC document JEP157 states that 250-V CDM allows safe manufacturing with a standard ESD control process.

### 5.3 Recommended Operating Conditions

over operating free-air temperature range (unless otherwise noted)

		MIN	NOM	MAX	UNIT
V <sub>IN</sub>	Input voltage	2.5		16	V
V <sub>OUT</sub>	Output voltage	0.8		13.5	
I <sub>OUT</sub>	Output current (2.5 V ≤ V <sub>IN</sub> < 3 V)	0		0.8	A
I <sub>OUT</sub>	Output current (V <sub>IN</sub> ≥ 3 V)	0		1	
C <sub>OUT</sub> ESR	Output capacitor ESR	2		500	mΩ
C <sub>OUT</sub>	Output capacitor <sup>(1)</sup>	1	2.2	220	μF
C <sub>IN</sub>	Input capacitor <sup>(2)</sup>		1		
T <sub>J</sub>	Junction temperature	-40		125	°C

- (1) Effective output capacitance of 0.47 μF minimum required for stability.
- (2) An input capacitor is not required for LDO stability. However, an input capacitor with an effective value of 0.47 μF minimum is recommended to counteract the effect of source resistance and inductance, which may in some cases cause symptoms of systemlevel instability such as ringing or oscillation, especially in the presence of load transients

## 5.4 Thermal Information

THERMAL METRIC <sup>(1)</sup>		TLV761		UNIT
		DCY (SOT–223)	KVU (TO–252)	
		4 PINS	4 PINS	
R <sub>θJA</sub>	Junction-to-ambient thermal resistance	95.4	67.2	°C/W
R <sub>θJC(top)</sub>	Junction-to-case (top) thermal resistance	55.6	71.8	°C/W
R <sub>θJB</sub>	Junction-to-board thermal resistance	33.7	45.5	°C/W
Ψ <sub>JT</sub>	Junction-to-top characterization parameter	13.9	31.6	°C/W
Ψ <sub>JB</sub>	Junction-to-board characterization parameter	33.4	45.4	°C/W
R <sub>θJC(bot)</sub>	Junction-to-case (bottom) thermal resistance	N/A	40.5	°C/W

(1) For more information about traditional and new thermal metrics, see the [Semiconductor and IC Package Thermal Metrics](#) application note.

## 5.5 Electrical Characteristics

specified at T<sub>J</sub> = –40°C to 125°C, V<sub>IN</sub> = V<sub>OUT(nom)</sub> + 1.5V or V<sub>IN</sub> = 2.5V (whichever is greater), I<sub>OUT</sub> = 10mA, C<sub>IN</sub> = 1.0μF and C<sub>OUT</sub> = 1.0μF (unless otherwise noted); typical values are at T<sub>J</sub> = 25°C

PARAMETER		TEST CONDITIONS	MIN	TYP	MAX	UNIT
V <sub>OUT</sub>	Nominal output accuracy	T <sub>J</sub> = 25°C	–1		1	%
V <sub>OUT</sub>	Output accuracy over temperature	V <sub>IN</sub> ≥ 3.0V, V <sub>OUT(NOM)</sub> ≤ 9.0V, 1mA ≤ I <sub>OUT</sub> ≤ 1A	–1.75		1.75	%
		V <sub>OUT(NOM)</sub> > 9.0V, 1mA ≤ I <sub>OUT</sub> ≤ 1A	–1.5		1.5	
ΔV <sub>OUT(ΔVIN)</sub>	Line regulation <sup>(1)</sup>	V <sub>OUT(NOM)</sub> ≤ 9.0V, V <sub>OUT(NOM)</sub> + 1.5V ≤ V <sub>IN</sub> ≤ 16V, I <sub>OUT</sub> = 10mA			0.02	%/V
		V <sub>OUT(NOM)</sub> > 9.0V, V <sub>OUT(NOM)</sub> + 1.5V ≤ V <sub>IN</sub> ≤ 16V, I <sub>OUT</sub> = 10mA			9.9	mV
ΔV <sub>OUT(ΔIOUT)</sub>	Load regulation	1mA ≤ I <sub>OUT</sub> ≤ 1A, V <sub>IN</sub> ≥ 3.0V		0.1	0.75	%/A
V <sub>DO</sub>	Dropout voltage <sup>(2)</sup>	V <sub>IN</sub> ≥ 3.0V, I <sub>OUT</sub> = 1A		0.9	1.6	V
I <sub>CL</sub>	Output current limit	V <sub>OUT</sub> = 0.9 × V <sub>OUT(NOM)</sub> , V <sub>IN</sub> ≥ 3.0V	1.1		1.6	A
I <sub>SC</sub>	Short-circuit current limit	V <sub>OUT</sub> = 0V	150	250	350	mA
I <sub>Q</sub>	Quiescent current	I <sub>OUT</sub> = 0mA		65	100	μA
I <sub>PULLDOWN</sub>	Output pulldown current <sup>(3)</sup>	V <sub>IN</sub> = 1.8V, V <sub>OUT</sub> = 2.5V	0.7		1.1	mA
PSRR	Power-supply rejection ratio	V <sub>IN</sub> = 3.3V, V <sub>OUT</sub> = 1.8V, I <sub>OUT</sub> = 300mA, f = 120Hz		70		dB
V <sub>n</sub>	Output noise voltage	BW = 10Hz to 100kHz, V <sub>IN</sub> = 3.3V, V <sub>OUT</sub> = 0.8V, I <sub>OUT</sub> = 100mA		60		μV <sub>RMS</sub>
V <sub>UVLO+</sub>	UVLO threshold rising	V <sub>IN</sub> rising		2.2	2.4	V
V <sub>UVLO(HYS)</sub>	UVLO hysteresis			130		mV
V <sub>UVLO-</sub>	UVLO threshold falling	V <sub>IN</sub> falling	1.9			V
T <sub>SD(shutdown)</sub>	Thermal shutdown temperature	Temperature increasing		180		°C
T <sub>SD(reset)</sub>	Thermal shutdown reset temperature	Temperature falling		160		°C

(1) Line regulation is measured with V<sub>IN</sub> = V<sub>OUT(NOM)</sub> + 1.5 V or 2.5 V (whichever is greater).

(2) V<sub>DO</sub> is measured with V<sub>IN</sub> = 95% × V<sub>OUT(nom)</sub> for fixed output devices. V<sub>DO</sub> is not measured for fixed output devices when V<sub>OUT</sub> < 2.5 V.

(3) I<sub>PULLDOWN</sub> is measured with V<sub>IN</sub> = 1.8 V (lower than UVLO falling threshold, with LDO in disabled state) and 2.5 V applied on V<sub>OUT</sub> externally.

### 5.6 Typical Characteristics

at operating temperature  $T_J = 25^\circ\text{C}$ ,  $V_{IN} = V_{OUT(NOM)} + 1.5\text{ V}$  or  $2.5\text{ V}$  (whichever is greater),  $I_{OUT} = 10\text{ mA}$ ,  $C_{IN} = 1.0\ \mu\text{F}$ , and  $C_{OUT} = 1.0\ \mu\text{F}$  (unless otherwise noted)

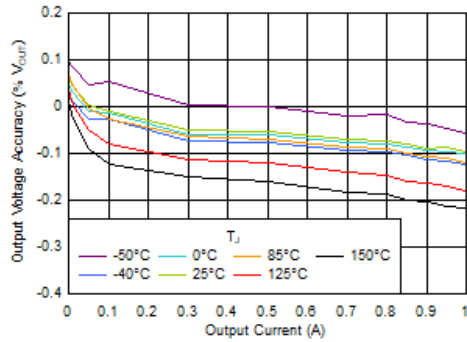

For  $V_{IN} \geq 3.0\text{ V}$

Figure 5-1.  $V_{OUT}$  Accuracy vs  $I_{OUT}$

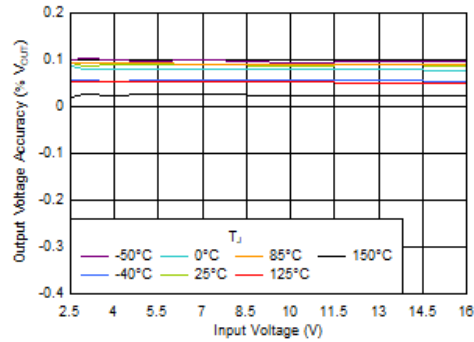

$I_{OUT} = 10\text{ mA}$

Figure 5-2.  $V_{OUT}$  Accuracy vs  $V_{IN}$

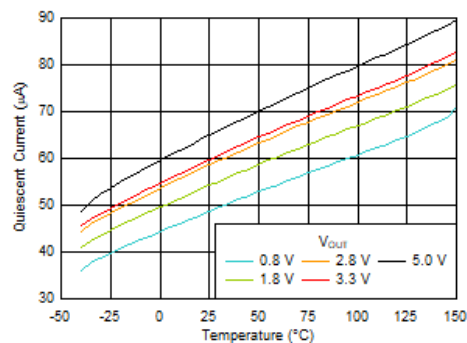

$I_{OUT} = 0\text{ mA}$

Figure 5-3.  $I_Q$  vs Temperature

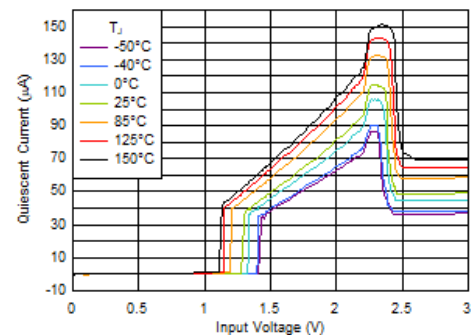

$I_{OUT} = 0\text{ mA}$

Figure 5-4.  $I_Q$  Increase Below Minimum  $V_{IN}$

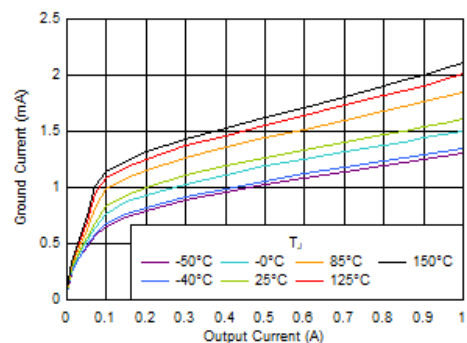

For  $V_{IN} \geq 3.0\text{ V}$

Figure 5-5.  $I_{GND}$  vs  $I_{OUT}$

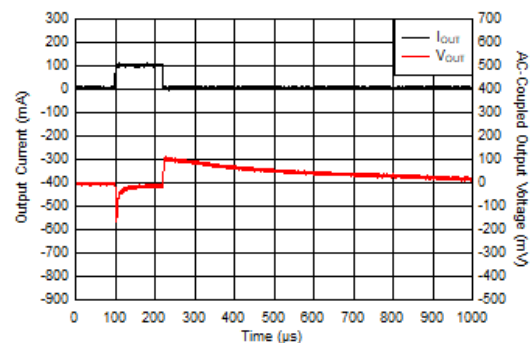

$V_{IN} = 5\text{ V}$ ,  $V_{OUT} = 3.3\text{ V}$ , ramp rate =  $0.4\text{ A}/\mu\text{s}$

Figure 5-6.  $I_{OUT}$  Transient From  $0\text{ mA}$  to  $100\text{ mA}$

### 5.6 Typical Characteristics (continued)

at operating temperature  $T_J = 25^\circ\text{C}$ ,  $V_{IN} = V_{OUT(NOM)} + 1.5\text{ V}$  or  $2.5\text{ V}$  (whichever is greater),  $I_{OUT} = 10\text{ mA}$ ,  $C_{IN} = 1.0\ \mu\text{F}$ , and  $C_{OUT} = 1.0\ \mu\text{F}$  (unless otherwise noted)

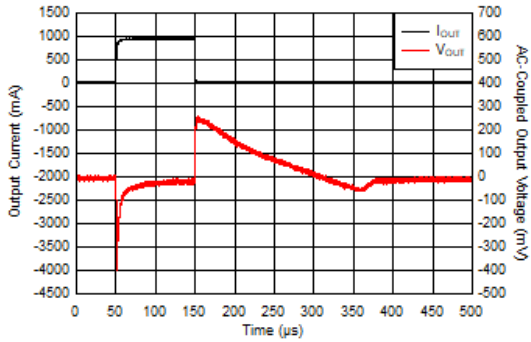

$V_{IN} = 5\text{ V}$ ,  $V_{OUT} = 3.3\text{ V}$ , ramp rate =  $0.5\text{ A}/\mu\text{s}$

Figure 5-7.  $I_{OUT}$  Transient From 1 mA to 1 A

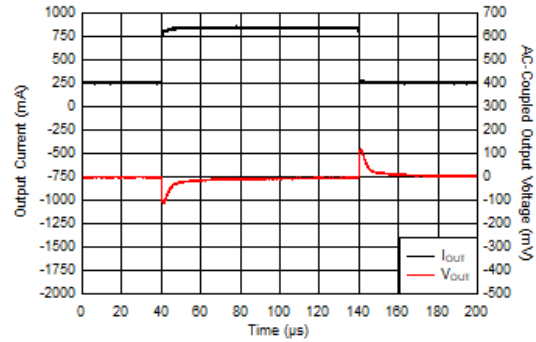

$V_{IN} = 5\text{ V}$ ,  $V_{OUT} = 3.3\text{ V}$ , ramp rate =  $0.8\text{ A}/\mu\text{s}$

Figure 5-8.  $I_{OUT}$  Transient From 250 mA to 850 mA

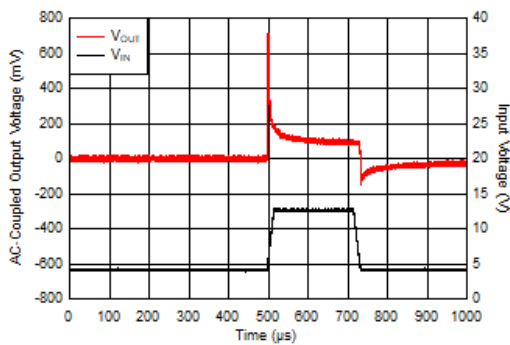

$V_{IN} = 5\text{ V}$ ,  $V_{OUT} = 3.3\text{ V}$ ,  $I_{OUT} = 1\text{ A}$ ,  $V_{IN}$  ramp rate =  $0.6\text{ V}/\mu\text{s}$

Figure 5-9.  $V_{IN}$  Transient in Dropout From 4 V to 13 V

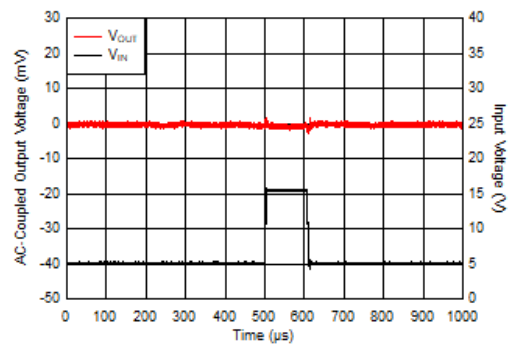

$V_{OUT} = 3.3\text{ V}$ ,  $I_{OUT} = 33\ \mu\text{A}$ ,  $V_{IN}$  ramp rate =  $1.6\text{ V}/\mu\text{s}$

Figure 5-10.  $V_{IN}$  Transient From 5 V to 16 V

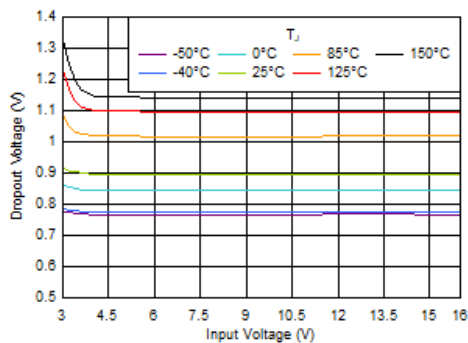

$I_{OUT} = 1.0\text{ A}$

Figure 5-11.  $V_{DO}$  vs  $V_{IN}$

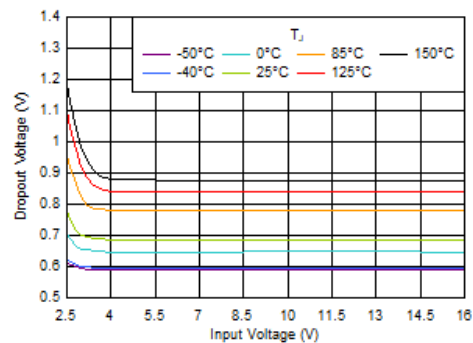

$I_{OUT} = 0.8\text{ A}$

Figure 5-12.  $V_{DO}$  vs  $V_{IN}$

### 5.6 Typical Characteristics (continued)

at operating temperature  $T_J = 25^\circ\text{C}$ ,  $V_{IN} = V_{OUT(NOM)} + 1.5\text{ V}$  or  $2.5\text{ V}$  (whichever is greater),  $I_{OUT} = 10\text{ mA}$ ,  $C_{IN} = 1.0\ \mu\text{F}$ , and  $C_{OUT} = 1.0\ \mu\text{F}$  (unless otherwise noted)

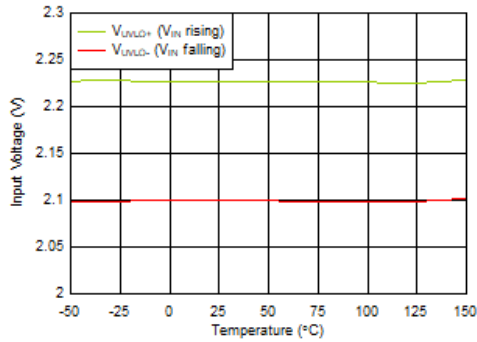
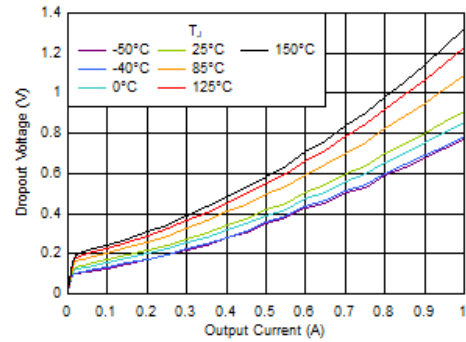
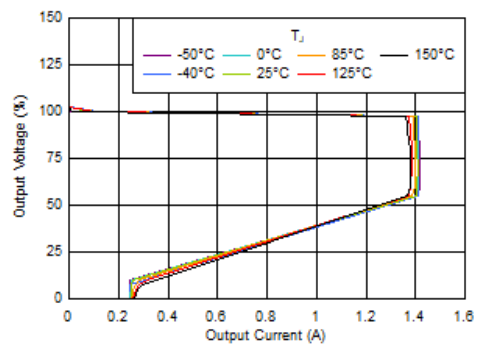

Figure 5-13. UVLO Thresholds vs Temperature



For  $V_{IN} \geq 3.0\text{ V}$

Figure 5-14.  $V_{D0}$  vs  $I_{OUT}$



For  $V_{IN} \geq 3.0\text{ V}$

Figure 5-15. Foldback Current Limit vs Temperature

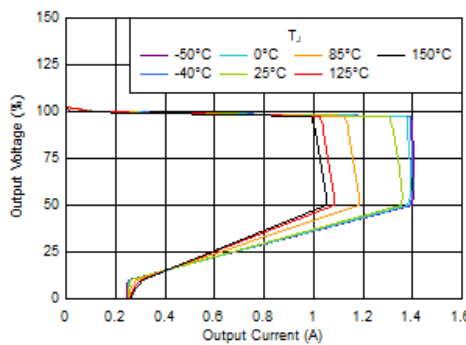
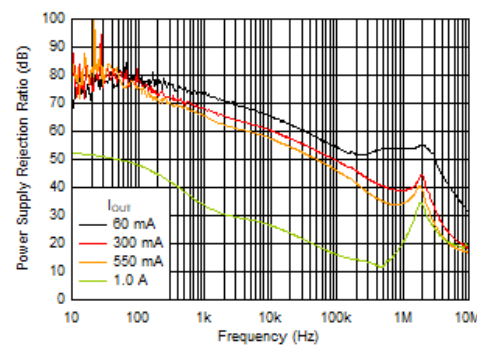
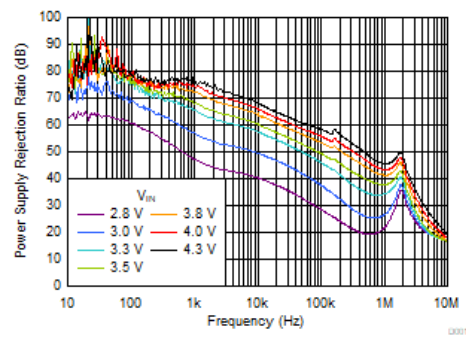

Figure 5-16. Foldback Current Limit vs Temperature



$V_{OUT} = 1.8\text{ V}$ ,  $V_{IN} = 3.3\text{ V}$

Figure 5-17. PSRR vs  $I_{OUT}$



$V_{OUT} = 1.8\text{ V}$ ,  $I_{OUT} = 0.55\text{ A}$

Figure 5-18. PSRR vs  $V_{IN}$



### 5.6 Typical Characteristics (continued)

at operating temperature  $T_J = 25^\circ\text{C}$ ,  $V_{IN} = V_{OUT(NOM)} + 1.5\text{ V}$  or  $2.5\text{ V}$  (whichever is greater),  $I_{OUT} = 10\text{ mA}$ ,  $C_{IN} = 1.0\text{ }\mu\text{F}$ , and  $C_{OUT} = 1.0\text{ }\mu\text{F}$  (unless otherwise noted)

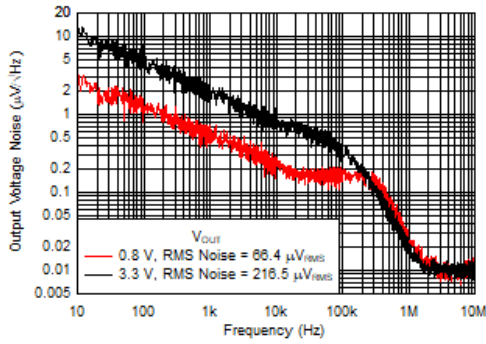

$I_{OUT} = 0.1\text{ A}$ , RMS noise BW = 10 Hz to 100 kHz

**Figure 5-19. Output Noise ( $V_n$ ) vs  $V_{OUT}$**

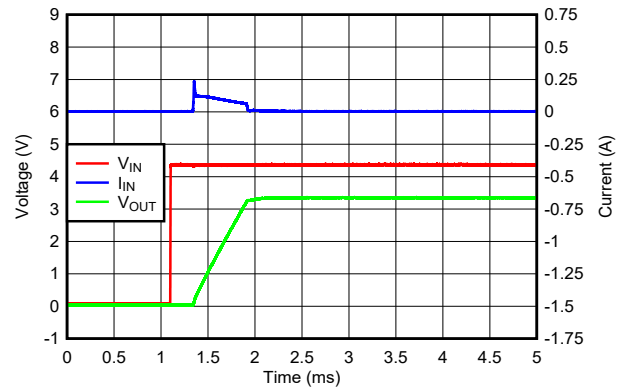

$I_{OUT} = 0.1\text{ A}$ ,  $C_{OUT} = 22\text{ }\mu\text{F}$

**Figure 5-20. Inrush Current With  $22\text{ }\mu\text{F}$  at  $C_{OUT}$**

## 6 Detailed Description

### 6.1 Overview

The TLV761 is a low quiescent current, high PSRR linear regulator capable of sourcing load current up to 1 A. This device is designed for high current applications such as appliances where there are increasingly stringent requirements for standby and active power consumption.

This device features integrated foldback current limit, thermal shutdown, internal output pulldown, and undervoltage lockout (UVLO). This device delivers excellent line and load transient performance. The TLV761 is low noise and exhibits very good PSRR. The operating ambient temperature range of the device is  $-40^{\circ}\text{C}$  to  $+125^{\circ}\text{C}$ .

### 6.2 Functional Block Diagram

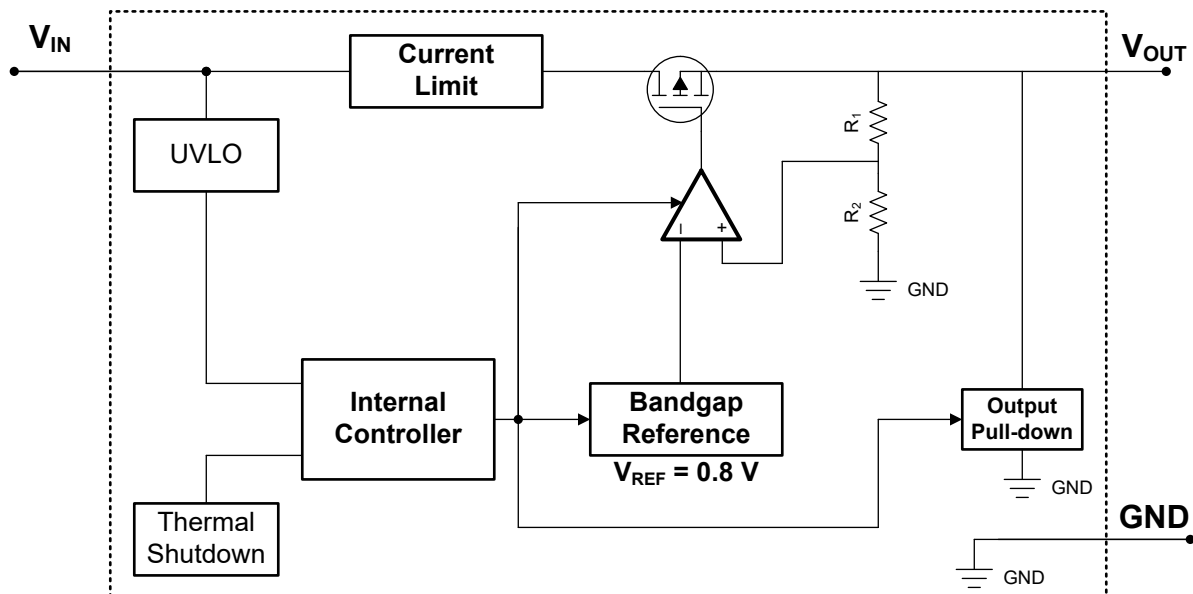

### 6.3 Feature Description

#### 6.3.1 Dropout Voltage

Dropout voltage ( $V_{DO}$ ) is defined as the input voltage minus the output voltage ( $V_{IN} - V_{OUT}$ ) at the rated output current ( $I_{RATED}$ ), where the pass transistor is fully on.  $I_{RATED}$  is the maximum  $I_{OUT}$  listed in the [Recommended Operating Conditions](#) table. The pass transistor is in the ohmic or triode region of operation, and acts as a switch. The dropout voltage indirectly specifies a minimum input voltage greater than the nominal programmed output voltage at which the output voltage is expected to stay in regulation. If the input voltage falls to less than the nominal output regulation, then the output voltage falls as well.

For a CMOS regulator, the dropout voltage is determined by the drain-source on-state resistance ( $R_{DS(ON)}$ ) of the pass transistor. Therefore, if the linear regulator operates at less than the rated current, the dropout voltage for that current scales accordingly. The following equation calculates the  $R_{DS(ON)}$  of the device.

$$R_{DS(ON)} = \frac{V_{DO}}{I_{RATED}} \quad (1)$$

### 6.3.2 Foldback Current Limit

The device has an internal current limit circuit that protects the regulator during transient high-load current faults or shorting events. The current limit is a hybrid brick-wall-foldback scheme. The current limit transitions from a brick-wall scheme to a foldback scheme at the foldback voltage ( $V_{FOLDBACK}$ ). In a high-load current fault with the output voltage above  $V_{FOLDBACK}$ , the brick-wall scheme limits the output current to the current limit ( $I_{CL}$ ). When the voltage drops below  $V_{FOLDBACK}$ , a foldback current limit activates that scales back the current as the output voltage approaches GND. When the output is shorted, the device supplies a typical current called the short-circuit current limit ( $I_{SC}$ ).  $I_{CL}$  and  $I_{SC}$  are listed in the [Electrical Characteristics](#) table.

For this device,  $V_{FOLDBACK} = 50\% \times V_{OUT(nom)}$ .

The output voltage is not regulated when the device is in current limit. When a current limit event occurs, the device begins to heat up because of the increase in power dissipation. When the device is in brick-wall current limit, the pass transistor dissipates power  $[(V_{IN} - V_{OUT}) \times I_{CL}]$ . When the device output is shorted and the output is below  $V_{FOLDBACK}$ , the pass transistor dissipates power  $[(V_{IN} - V_{OUT}) \times I_{SC}]$ . If thermal shutdown is triggered, the device turns off. After the device cools down, the internal thermal shutdown circuit turns the device back on. If the output current fault condition continues, the device cycles between current limit and thermal shutdown. For more information on current limits, see the [Know Your Limits application note](#).

Figure 6-1 shows a diagram of the foldback current limit.

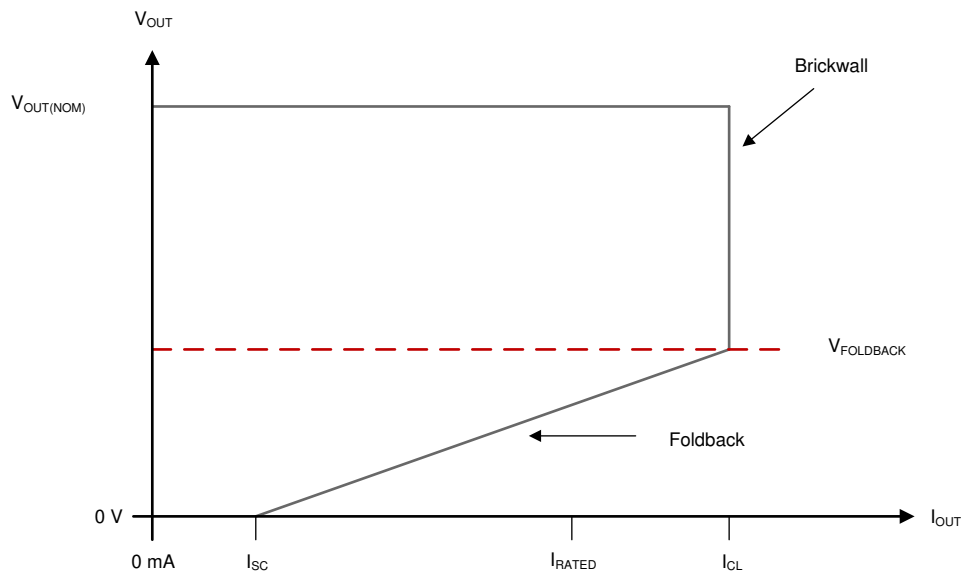

Figure 6-1. Foldback Current Limit

### 6.3.3 Undervoltage Lockout (UVLO)

The device has an independent undervoltage lockout (UVLO) circuit that monitors the input voltage, allowing a controlled and consistent turn on and off of the output voltage. To prevent the device from turning off if the input drops during turn on, the UVLO has hysteresis as specified in the [Electrical Characteristics](#) table.

### 6.3.4 Thermal Shutdown

The device contains a thermal shutdown protection circuit to disable the device when the junction temperature ( $T_J$ ) of the pass transistor rises to  $T_{SD(\text{shutdown})}$  (typical). Thermal shutdown hysteresis assures that the device resets (turns on) when the temperature falls to  $T_{SD(\text{reset})}$  (typical).

The thermal time-constant of the semiconductor die is fairly short, thus the device may cycle on and off when thermal shutdown is reached until power dissipation is reduced. Power dissipation during start-up can be high from large  $V_{IN} - V_{OUT}$  voltage drops across the device or from high inrush currents charging large output capacitors. Under some conditions, the thermal shutdown protection disables the device before start-up completes.

For reliable operation, limit the junction temperature to the maximum listed in the [Recommended Operating Conditions](#) table. Operation above this maximum temperature causes the device to exceed operational specifications. Although the internal protection circuitry of the device is designed to protect against thermal overall conditions, this circuitry is not intended to replace proper heat sinking. Continuously running the device into thermal shutdown or above the maximum recommended junction temperature reduces long-term reliability.

## 6.4 Device Functional Modes

### 6.4.1 Device Functional Mode Comparison

Table 6-1 shows the conditions that lead to the different modes of operation. See the [Electrical Characteristics](#) table for parameter values.

**Table 6-1. Device Functional Mode Comparison**

OPERATING MODE	PARAMETER		
	$V_{IN}$	$I_{OUT}$	$T_J$
Normal operation	$V_{IN} > V_{OUT(\text{nom})} + V_{DO}$ and $V_{IN} > V_{IN(\text{min})}$	$I_{OUT} < I_{OUT(\text{max})}$	$T_J < T_{SD(\text{shutdown})}$
Dropout operation	$V_{IN(\text{min})} < V_{IN} < V_{OUT(\text{nom})} + V_{DO}$	$I_{OUT} < I_{OUT(\text{max})}$	$T_J < T_{SD(\text{shutdown})}$
Disabled (any true condition disables the device)	$V_{IN} < V_{UVLO}$	Not applicable	$T_J > T_{SD(\text{shutdown})}$

### 6.4.2 Normal Operation

The device regulates to the nominal output voltage when the following conditions are met:

- The input voltage is greater than the nominal output voltage plus the dropout voltage ( $V_{OUT(\text{nom})} + V_{DO}$ )
- The output current is less than the current limit ( $I_{OUT} < I_{CL}$ )
- The device junction temperature is less than the thermal shutdown temperature ( $T_J < T_{SD}$ )

### 6.4.3 Dropout Operation

If the input voltage is lower than the nominal output voltage plus the specified dropout voltage, but all other conditions are met for normal operation, the device operates in dropout mode. In this mode, the output voltage tracks the input voltage. During this mode, the transient performance of the device becomes significantly degraded because the pass transistor is in the ohmic or triode region, and acts as a switch. Line or load transients in dropout can result in large output-voltage deviations.

When the device is in a steady dropout state (defined as when the device is in dropout,  $V_{IN} < V_{OUT(\text{NOM})} + V_{DO}$ , directly after being in a normal regulation state, but *not* during start-up), the pass transistor is driven into the ohmic or triode region. When the input voltage returns to a value greater than or equal to the nominal output voltage plus the dropout voltage ( $V_{OUT(\text{NOM})} + V_{DO}$ ), the output voltage can overshoot for a short period of time while the device pulls the pass transistor back into the linear region.

## 7 Application and Implementation

---

### Note

Information in the following applications sections is not part of the TI component specification, and TI does not warrant its accuracy or completeness. TI's customers are responsible for determining suitability of components for their purposes, as well as validating and testing their design implementation to confirm system functionality.

---

### 7.1 Application Information

#### 7.1.1 Recommended Capacitor Types

The device is designed to be stable using low equivalent series resistance (ESR) ceramic capacitors at the input and output. Multilayer ceramic capacitors have become the industry standard for these types of applications and are recommended, but must be used with good judgment. Ceramic capacitors that employ X7R-, X5R-, and C0G-rated dielectric materials provide relatively good capacitive stability across temperature, whereas the use of Y5V-rated capacitors is discouraged because of large variations in capacitance.

Regardless of the ceramic capacitor type selected, the effective capacitance varies with operating voltage and temperature. Generally, expect the effective capacitance to decrease by as much as 50%. The input and output capacitors recommended in the [Recommended Operating Conditions](#) table account for an effective capacitance of approximately 50% of the nominal value.

#### 7.1.2 Input and Output Capacitor Requirements

Although an input capacitor is not required for stability, good analog design practice is to connect a capacitor from IN to GND. This capacitor counteracts reactive input sources and improves transient response, input ripple, and PSRR. An input capacitor is recommended if the source impedance is more than 0.5  $\Omega$ . A higher value capacitor may be necessary if large, fast rise-time load or line transients are anticipated or if the device is located several inches from the input power source.

Dynamic performance of the device is improved with the use of an output capacitor. Use an output capacitor within the range specified in the [Recommended Operating Conditions](#) table for stability.

#### 7.1.3 Reverse Current

Excessive reverse current can damage this device. Reverse current flows through the intrinsic body diode of the pass transistor instead of the normal conducting channel. At high magnitudes, this current flow degrades the long-term reliability of the device.

Conditions where reverse current can occur are outlined in this section, all of which can exceed the absolute maximum rating of  $V_{OUT} \leq V_{IN} + 0.3 V$ .

- If the device has a large  $C_{OUT}$  and the input supply collapses with little or no load current
- The output is biased when the input supply is not established
- The output is biased above the input supply

If reverse current flow is expected in the application, external protection is recommended to protect the device. Reverse current is not limited in the device, so external limiting is required if extended reverse voltage operation is anticipated.

Figure 7-1 shows one approach for protecting the device.

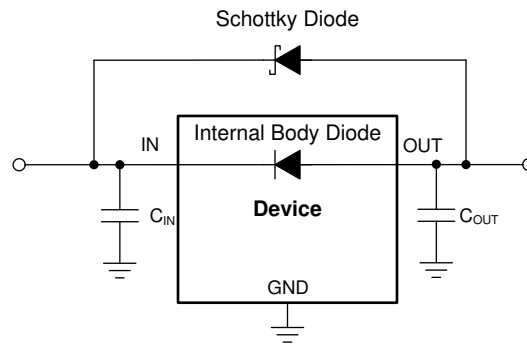

**Figure 7-1. Example Circuit for Reverse Current Protection Using a Schottky Diode**

#### 7.1.4 Power Dissipation ( $P_D$ )

Circuit reliability requires consideration of the device power dissipation, location of the circuit on the printed circuit board (PCB), and correct sizing of the thermal plane. The PCB area around the regulator must have few or no other heat-generating devices that cause added thermal stress.

To first-order approximation, power dissipation in the regulator depends on the input-to-output voltage difference and load conditions. The following equation calculates power dissipation ( $P_D$ ).

$$P_D = (V_{IN} - V_{OUT}) \times I_{OUT} \quad (2)$$

#### Note

Power dissipation can be minimized, and therefore greater efficiency can be achieved, by correct selection of the system voltage rails. For the lowest power dissipation use the minimum input voltage required for correct output regulation.

For devices with a thermal pad, the primary heat conduction path for the device package is through the thermal pad to the PCB. Solder the thermal pad to a copper pad area under the device. This pad area must contain an array of plated vias that conduct heat to additional copper planes for increased heat dissipation.

The maximum power dissipation determines the maximum allowable ambient temperature ( $T_A$ ) for the device. According to the following equation, power dissipation and junction temperature are most often related by the junction-to-ambient thermal resistance ( $R_{\theta JA}$ ) of the combined PCB and device package and the temperature of the ambient air ( $T_A$ ).

$$T_J = T_A + (R_{\theta JA} \times P_D) \quad (3)$$

Thermal resistance ( $R_{\theta JA}$ ) is highly dependent on the heat-spreading capability built into the particular PCB design, and therefore varies according to the total copper area, copper weight, and location of the planes. The junction-to-ambient thermal resistance listed in the [Thermal Information](#) table is determined by the JEDEC standard PCB and copper-spreading area, and is used as a relative measure of package thermal performance.

### 7.1.5 Estimating Junction Temperature

The JEDEC standard now recommends the use of psi ( $\Psi$ ) thermal metrics to estimate the junction temperatures of the linear regulator when in-circuit on a typical PCB board application. These metrics are not thermal resistance parameters and instead offer a practical and relative way to estimate junction temperature. These psi metrics are determined to be significantly independent of the copper area available for heat-spreading. The [Thermal Information](#) table lists the primary thermal metrics, which are the junction-to-top characterization parameter ( $\psi_{JT}$ ) and junction-to-board characterization parameter ( $\psi_{JB}$ ). These parameters provide two methods for calculating the junction temperature ( $T_J$ ). As described in the following equations, use the junction-to-top characterization parameter ( $\psi_{JT}$ ) with the temperature at the center-top of device package ( $T_T$ ) to calculate the junction temperature. Use the junction-to-board characterization parameter ( $\psi_{JB}$ ) with the PCB surface temperature 1 mm from the device package ( $T_B$ ) to calculate the junction temperature.

$$T_J = T_T + \psi_{JT} \times P_D \quad (4)$$

where:

- $P_D$  is the dissipated power
- $T_T$  is the temperature at the center-top of the device package

$$T_J = T_B + \psi_{JB} \times P_D \quad (5)$$

where:

- $T_B$  is the PCB surface temperature measured 1 mm from the device package and centered on the package edge

For detailed information on the thermal metrics and how to use them, see the [Semiconductor and IC Package Thermal Metrics](#) application note.

### 7.2 Typical Application

The TLV761 is a low quiescent current linear regulator designed for high current applications. Unlike most typical high current linear regulators, the TLV761 consumes significantly less quiescent current. This device delivers excellent line and load transient performance. The device is low noise and exhibits a very good PSRR. As a result, the TLV761 is designed for high current applications that require very sensitive power-supply rails.

This regulator offers both current limit and thermal protection. The operating ambient temperature range of the device is  $-40^\circ\text{C}$  to  $+125^\circ\text{C}$ .

Figure 7-2 shows a typical application circuit for this device.

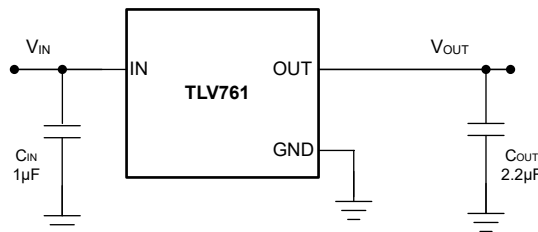

Figure 7-2. Typical Application Circuit

### 7.2.1 Design Requirements

For this design example, use the parameters listed in [Table 7-1](#) as the input parameters.

**Table 7-1. Design Parameters**

PARAMETER	DESIGN REQUIREMENT
Input voltage	12 V
Output voltage	3.3 V
Output current	50 mA

### 7.2.2 Detailed Design Procedure

For this design example, the 3.3-V, fixed-version TLV76133 is selected and is powered by a standard 12-V input supply. The dropout voltage ( $V_{DO}$ ) is kept within the TLV761 dropout voltage specification for the 3.3-V output voltage option to keep the device in regulation under all load and temperature conditions for this design. A 1.0- $\mu$ F output capacitor is recommended for excellent load transient response. The input capacitor is optional and is used to reduce the input impedance of the circuit and improve the transient response.

As with any regulator, increasing the size of the output capacitor reduces overshoot and undershoot magnitude.

### 7.3 Best Design Practices

Place input and output capacitors as close to the device as possible.

Use a ceramic output capacitor.

Do not exceed the device absolute maximum ratings.

### 7.4 Power Supply Recommendations

Connect a low output impedance power supply directly to the INPUT pin of the device. Inductive impedances between the input supply and the INPUT pin can create significant voltage excursions at the INPUT pin during start-up or load transient events.



## 7.5 Layout

### 7.5.1 Layout Guidelines

Place input and output capacitors as close to the device pins as possible. To improve characteristic AC performance such as PSRR, output noise, and transient response, design the board with separate ground planes for  $V_{IN}$  and  $V_{OUT}$ , with the ground plane connected only at the GND pin of the device. In addition, the ground connection for the output capacitor must be connected directly to the GND pin of the device. Higher value ESR capacitors can degrade PSRR performance.

### 7.5.2 Layout Examples

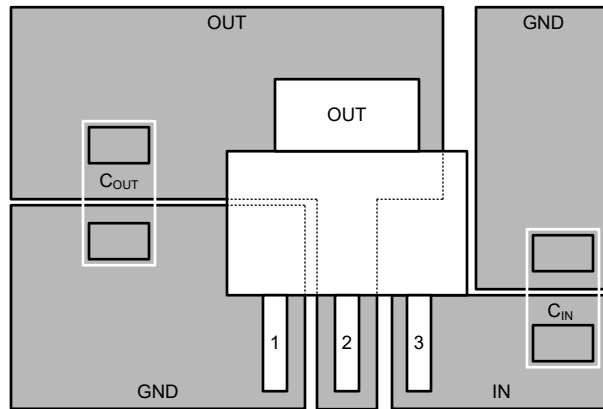

Figure 7-3. Layout Example for DCY (SOT-223) Package

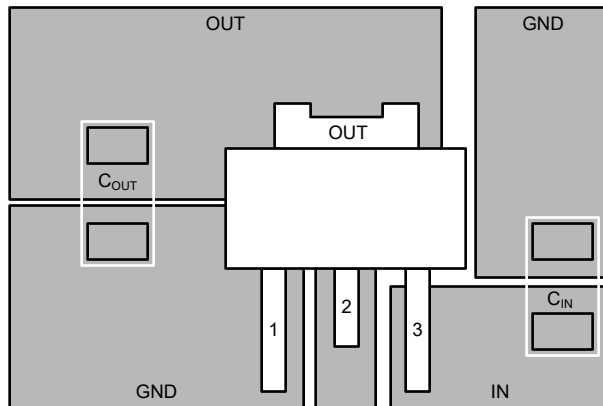

Figure 7-4. Layout Example for KVU (TO-252) Package

## 8 Device and Documentation Support

### 8.1 Device Support

#### 8.1.1 Device Nomenclature

**Table 8-1. Available Options<sup>(1) (2)</sup>**

PRODUCT	V <sub>OUT</sub>
TLV761xxyyyz	<b>xx</b> is the nominal output voltage (for example 33 = 3.3 V). <b>yyy</b> is the package designator. <b>z</b> is the package quantity.

- (1) For the most current package and ordering information, see the Package Option Addendum at the end of this document, or visit the device product folder at [www.ti.com](http://www.ti.com).
- (2) The device is available in factory-programmable fixed output voltage increments of 50 mV upon request.

### 8.2 Documentation Support

#### 8.2.1 Related Documentation

For related documentation see the following:

- Texas Instruments, [TLV1117 Adjustable and Fixed Low-Dropout Voltage Regulator data sheet](#)
- Texas Instruments, [LM1117 800-mA Low-Dropout Linear Regulator data sheet](#)

### 8.3 Receiving Notification of Documentation Updates

To receive notification of documentation updates, navigate to the device product folder on [ti.com](http://ti.com). Click on *Notifications* to register and receive a weekly digest of any product information that has changed. For change details, review the revision history included in any revised document.

### 8.4 Support Resources

[TI E2E™ support forums](#) are an engineer's go-to source for fast, verified answers and design help — straight from the experts. Search existing answers or ask your own question to get the quick design help you need.

Linked content is provided "AS IS" by the respective contributors. They do not constitute TI specifications and do not necessarily reflect TI's views; see TI's [Terms of Use](#).

### 8.5 Trademarks

TI E2E™ is a trademark of Texas Instruments.

All trademarks are the property of their respective owners.

### 8.6 Electrostatic Discharge Caution



This integrated circuit can be damaged by ESD. Texas Instruments recommends that all integrated circuits be handled with appropriate precautions. Failure to observe proper handling and installation procedures can cause damage.

ESD damage can range from subtle performance degradation to complete device failure. Precision integrated circuits may be more susceptible to damage because very small parametric changes could cause the device not to meet its published specifications.

### 8.7 Glossary

#### [TI Glossary](#)

This glossary lists and explains terms, acronyms, and definitions.

## 9 Revision History

NOTE: Page numbers for previous revisions may differ from page numbers in the current version.

<b>Changes from Revision B (February 2023) to Revision C (April 2024)</b>	<b>Page</b>
• Added KVU (TO-252) package to document as <i>Advance Information</i> .....	1
• Added KVU package information to <i>Pin Configuration and Functions</i> section.....	3
• Increased absolute maximum ratings to 20V for Input pin.....	4
• Added thermal numbers for KVU (TO-252) package.....	5
• Changed output voltage value from 5 V to 3.3 V in <i>Design Parameters</i> table.....	16
• Added <i>Layout Example for KVU (TO-252) Package</i> image to <i>Layout Examples</i> section.....	17

---

<b>Changes from Revision A (December 2022) to Revision B (February 2023)</b>	<b>Page</b>
• Deleted $I_{SHUTDOWN}$ curves and all data below $V_{IN} < 3.0$ V in <i>Electrical Characteristics</i> table and <i>Typical Characteristics</i> section.....	6

---

## 10 Mechanical, Packaging, and Orderable Information

The following pages include mechanical, packaging, and orderable information. This information is the most current data available for the designated devices. This data is subject to change without notice and revision of this document. For browser-based versions of this data sheet, refer to the left-hand navigation.

**PACKAGING INFORMATION**

Orderable Device	Status (1)	Package Type	Package Drawing	Pins	Package Qty	Eco Plan (2)	Lead finish/ Ball material (6)	MSL Peak Temp (3)	Op Temp (°C)	Device Marking (4/5)	Samples
PTLV76118DCYR	OBSOLETE	SOT-223	DCY	4		TBD	Call TI	Call TI	-40 to 125		
PTLV76133KVUR	ACTIVE	TO-252	KVU	3	2500	TBD	Call TI	Call TI	-40 to 125		Samples
PTLV76150KVUR	ACTIVE	TO-252	KVU	3	2500	TBD	Call TI	Call TI	-40 to 125		Samples
TLV76112DCYR	ACTIVE	SOT-223	DCY	4	2500	RoHS & Green	SN	Level-2-260C-1 YEAR	-40 to 125	76112C	Samples
TLV76118DCYR	ACTIVE	SOT-223	DCY	4	2500	RoHS & Green	SN	Level-2-260C-1 YEAR	-40 to 125	76118C	Samples
TLV76125DCYR	ACTIVE	SOT-223	DCY	4	2500	RoHS & Green	SN	Level-2-260C-1 YEAR	-40 to 125	76125C	Samples
TLV76130DCYR	ACTIVE	SOT-223	DCY	4	2500	RoHS & Green	SN	Level-2-260C-1 YEAR	-40 to 125	76130C	Samples
TLV76133DCYR	ACTIVE	SOT-223	DCY	4	2500	RoHS & Green	SN	Level-2-260C-1 YEAR	-40 to 125	76133C	Samples
TLV76136DCYR	ACTIVE	SOT-223	DCY	4	2500	RoHS & Green	SN	Level-2-260C-1 YEAR	-40 to 125	76136C	Samples
TLV76150DCYR	ACTIVE	SOT-223	DCY	4	2500	RoHS & Green	SN	Level-2-260C-1 YEAR	-40 to 125	76150C	Samples
TLV76180DCYR	ACTIVE	SOT-223	DCY	4	2500	RoHS & Green	SN	Level-2-260C-1 YEAR	-40 to 125	76180C	Samples
TLV761C0DCYR	ACTIVE	SOT-223	DCY	4	2500	RoHS & Green	SN	Level-2-260C-1 YEAR	-40 to 125	761C0C	Samples

(1) The marketing status values are defined as follows:

**ACTIVE:** Product device recommended for new designs.

**LIFEBUY:** TI has announced that the device will be discontinued, and a lifetime-buy period is in effect.

**NRND:** Not recommended for new designs. Device is in production to support existing customers, but TI does not recommend using this part in a new design.

**PREVIEW:** Device has been announced but is not in production. Samples may or may not be available.

**OBSOLETE:** TI has discontinued the production of the device.

(2) **RoHS:** TI defines "RoHS" to mean semiconductor products that are compliant with the current EU RoHS requirements for all 10 RoHS substances, including the requirement that RoHS substance do not exceed 0.1% by weight in homogeneous materials. Where designed to be soldered at high temperatures, "RoHS" products are suitable for use in specified lead-free processes. TI may reference these types of products as "Pb-Free".

**RoHS Exempt:** TI defines "RoHS Exempt" to mean products that contain lead but are compliant with EU RoHS pursuant to a specific EU RoHS exemption.

**Green:** TI defines "Green" to mean the content of Chlorine (Cl) and Bromine (Br) based flame retardants meet JS709B low halogen requirements of <=1000ppm threshold. Antimony trioxide based flame retardants must also meet the <=1000ppm threshold requirement.

- (3) MSL, Peak Temp. - The Moisture Sensitivity Level rating according to the JEDEC industry standard classifications, and peak solder temperature.
- (4) There may be additional marking, which relates to the logo, the lot trace code information, or the environmental category on the device.
- (5) Multiple Device Markings will be inside parentheses. Only one Device Marking contained in parentheses and separated by a "~" will appear on a device. If a line is indented then it is a continuation of the previous line and the two combined represent the entire Device Marking for that device.
- (6) Lead finish/Ball material - Orderable Devices may have multiple material finish options. Finish options are separated by a vertical ruled line. Lead finish/Ball material values may wrap to two lines if the finish value exceeds the maximum column width.

**Important Information and Disclaimer:**The information provided on this page represents TI's knowledge and belief as of the date that it is provided. TI bases its knowledge and belief on information provided by third parties, and makes no representation or warranty as to the accuracy of such information. Efforts are underway to better integrate information from third parties. TI has taken and continues to take reasonable steps to provide representative and accurate information but may not have conducted destructive testing or chemical analysis on incoming materials and chemicals. TI and TI suppliers consider certain information to be proprietary, and thus CAS numbers and other limited information may not be available for release.

In no event shall TI's liability arising out of such information exceed the total purchase price of the TI part(s) at issue in this document sold by TI to Customer on an annual basis.

**TAPE AND REEL INFORMATION**

**QUADRANT ASSIGNMENTS FOR PIN 1 ORIENTATION IN TAPE**

\*All dimensions are nominal

Device	Package Type	Package Drawing	Pins	SPQ	Reel Diameter (mm)	Reel Width W1 (mm)	A0 (mm)	B0 (mm)	K0 (mm)	P1 (mm)	W (mm)	Pin1 Quadrant
TLV76112DCYR	SOT-223	DCY	4	2500	330.0	12.4	7.05	7.4	1.9	8.0	12.0	Q3
TLV76125DCYR	SOT-223	DCY	4	2500	330.0	12.4	7.05	7.4	1.9	8.0	12.0	Q3
TLV76133DCYR	SOT-223	DCY	4	2500	330.0	12.4	7.05	7.4	1.9	8.0	12.0	Q3
TLV76150DCYR	SOT-223	DCY	4	2500	330.0	12.4	7.05	7.4	1.9	8.0	12.0	Q3

**TAPE AND REEL BOX DIMENSIONS**

\*All dimensions are nominal

Device	Package Type	Package Drawing	Pins	SPQ	Length (mm)	Width (mm)	Height (mm)
TLV76112DCYR	SOT-223	DCY	4	2500	340.0	340.0	38.0
TLV76125DCYR	SOT-223	DCY	4	2500	340.0	340.0	38.0
TLV76133DCYR	SOT-223	DCY	4	2500	340.0	340.0	38.0
TLV76150DCYR	SOT-223	DCY	4	2500	340.0	340.0	38.0

DCY (R-PDSO-G4)

PLASTIC SMALL-OUTLINE



- NOTES: A. All linear dimensions are in millimeters (inches).  
 B. This drawing is subject to change without notice.  
 C. Body dimensions do not include mold flash or protrusion.  
 D. Falls within JEDEC TO-261 Variation AA.



DCY (R-PDSO-G4)

PLASTIC SMALL OUTLINE

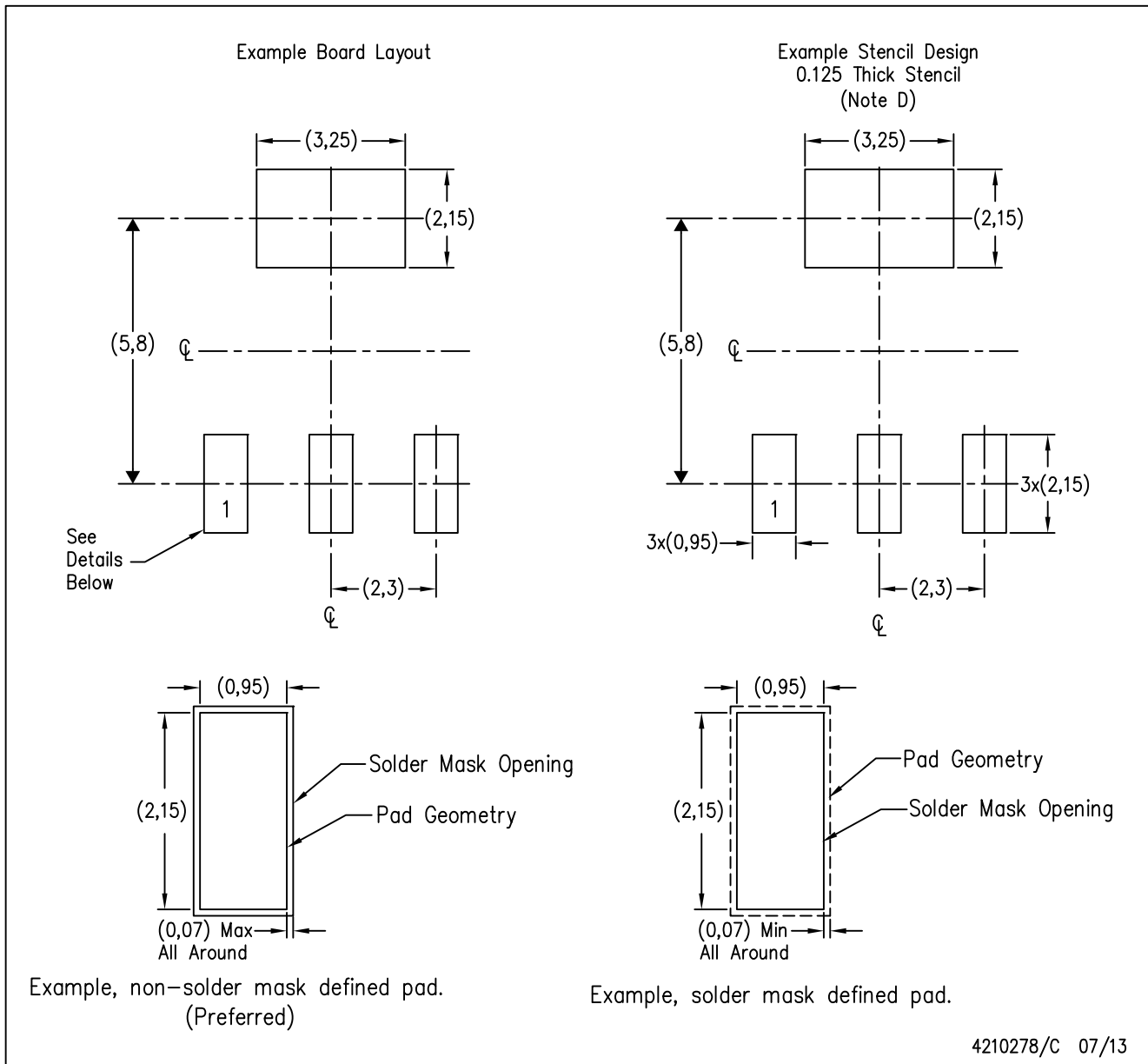

- NOTES:
- A. All linear dimensions are in millimeters.
  - B. This drawing is subject to change without notice.
  - C. Publication IPC-7351 is recommended for alternate designs.
  - D. Laser cutting apertures with trapezoidal walls and also rounding corners will offer better paste release. Customers should contact their board assembly site for stencil recommendations. Refer to IPC 7525 for stencil design considerations.

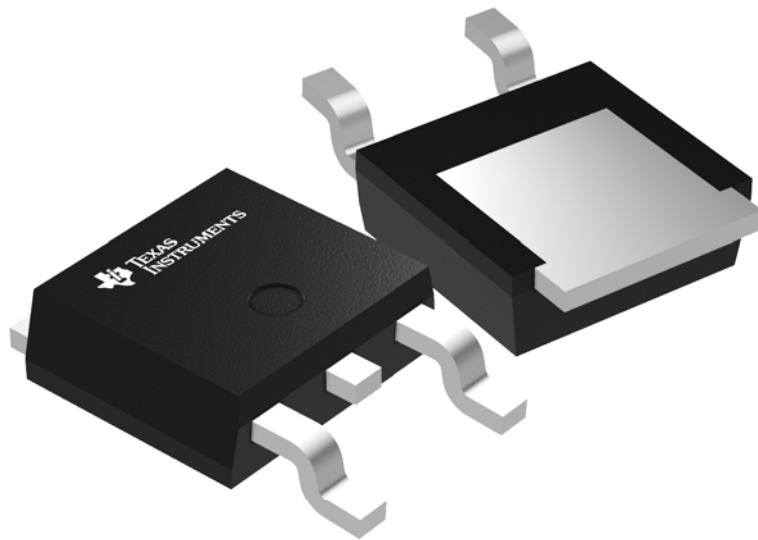

Images above are just a representation of the package family, actual package may vary.  
Refer to the product data sheet for package details.



# PACKAGE OUTLINE

## KVVU0003A

### TO-252 - 2.52 mm max height

TO-252

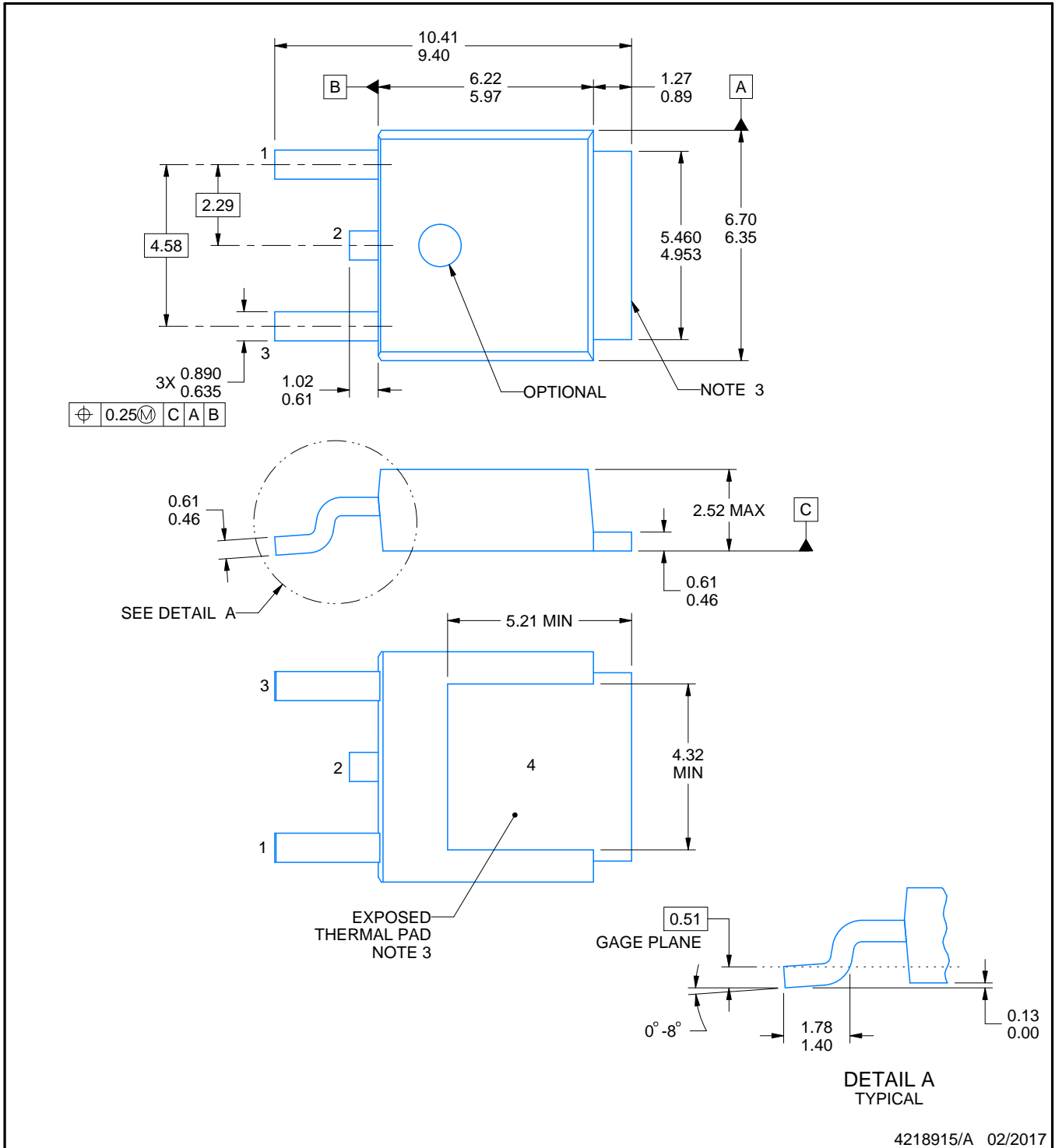

4218915/A 02/2017

#### NOTES:

1. All linear dimensions are in millimeters. Any dimensions in parenthesis are for reference only. Dimensioning and tolerancing per ASME Y14.5M.
2. This drawing is subject to change without notice.
3. Shape may vary per different assembly sites.
4. Reference JEDEC registration TO-252.

# EXAMPLE BOARD LAYOUT

KVU0003A

TO-252 - 2.52 mm max height

TO-252

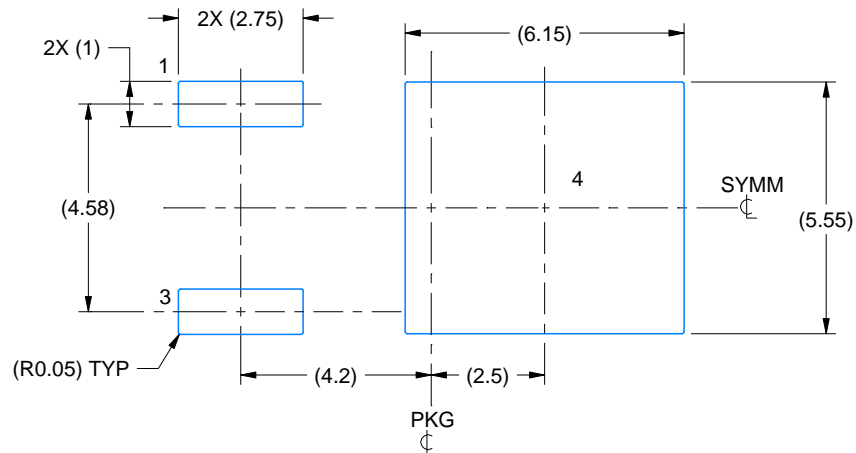

LAND PATTERN EXAMPLE  
EXPOSED METAL SHOWN  
SCALE:6X

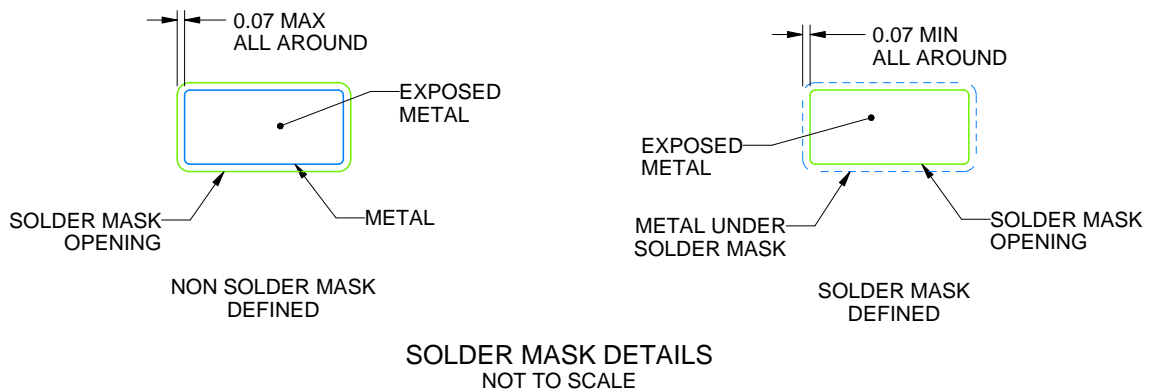

SOLDER MASK DETAILS  
NOT TO SCALE

4218915/A 02/2017

NOTES: (continued)

5. This package is designed to be soldered to a thermal pad on the board. For more information, see Texas Instruments literature numbers SLMA002 ([www.ti.com/lit/slm002](http://www.ti.com/lit/slm002)) and SLMA004 ([www.ti.com/lit/slma004](http://www.ti.com/lit/slma004)).
6. Vias are optional depending on application, refer to device data sheet. It is recommended that vias under paste be filled, plugged or tented.

# EXAMPLE STENCIL DESIGN

KVU0003A

TO-252 - 2.52 mm max height

TO-252

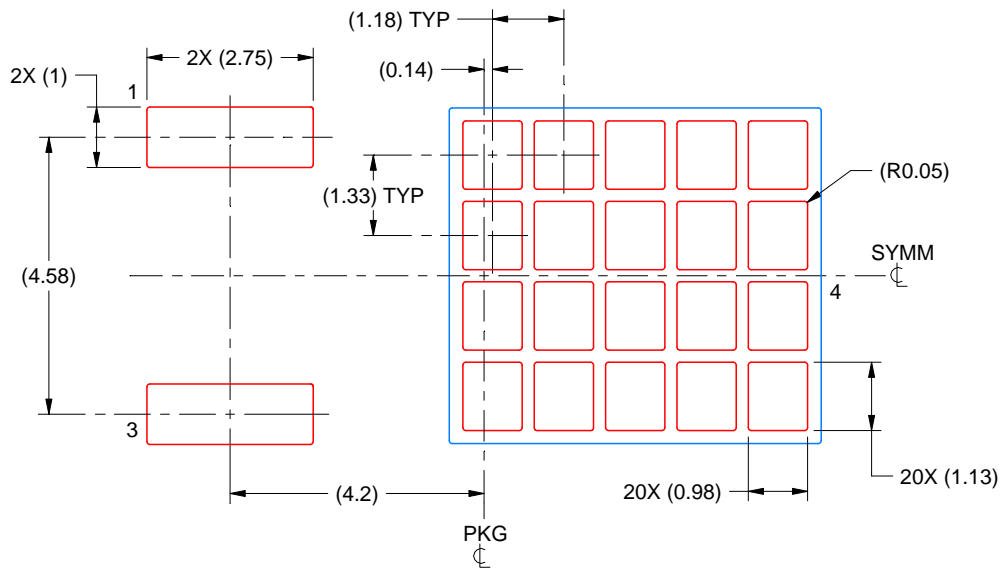

SOLDER PASTE EXAMPLE  
BASED ON 0.125 mm THICK STENCIL

EXPOSED PAD  
65% PRINTED SOLDER COVERAGE BY AREA  
SCALE:8X

4218915/A 02/2017

NOTES: (continued)

7. Laser cutting apertures with trapezoidal walls and rounded corners may offer better paste release. IPC-7525 may have alternate design recommendations.
8. Board assembly site may have different recommendations for stencil design.

## IMPORTANT NOTICE AND DISCLAIMER

TI PROVIDES TECHNICAL AND RELIABILITY DATA (INCLUDING DATA SHEETS), DESIGN RESOURCES (INCLUDING REFERENCE DESIGNS), APPLICATION OR OTHER DESIGN ADVICE, WEB TOOLS, SAFETY INFORMATION, AND OTHER RESOURCES "AS IS" AND WITH ALL FAULTS, AND DISCLAIMS ALL WARRANTIES, EXPRESS AND IMPLIED, INCLUDING WITHOUT LIMITATION ANY IMPLIED WARRANTIES OF MERCHANTABILITY, FITNESS FOR A PARTICULAR PURPOSE OR NON-INFRINGEMENT OF THIRD PARTY INTELLECTUAL PROPERTY RIGHTS.

These resources are intended for skilled developers designing with TI products. You are solely responsible for (1) selecting the appropriate TI products for your application, (2) designing, validating and testing your application, and (3) ensuring your application meets applicable standards, and any other safety, security, regulatory or other requirements.

These resources are subject to change without notice. TI grants you permission to use these resources only for development of an application that uses the TI products described in the resource. Other reproduction and display of these resources is prohibited. No license is granted to any other TI intellectual property right or to any third party intellectual property right. TI disclaims responsibility for, and you will fully indemnify TI and its representatives against, any claims, damages, costs, losses, and liabilities arising out of your use of these resources.

TI's products are provided subject to [TI's Terms of Sale](#) or other applicable terms available either on [ti.com](https://www.ti.com) or provided in conjunction with such TI products. TI's provision of these resources does not expand or otherwise alter TI's applicable warranties or warranty disclaimers for TI products.

TI objects to and rejects any additional or different terms you may have proposed.

Mailing Address: Texas Instruments, Post Office Box 655303, Dallas, Texas 75265  
Copyright © 2024, Texas Instruments Incorporated