

General Description

The WSD4070DN33 is the highest performance trench N-Channel MOSFETs with extreme high cell density, which provide excellent $R_{DS(ON)}$ and gate charge for most of the synchronous buck converter applications.

The WSD4070DN33 meet the RoHS and Green Product requirement, 100% E_{AS} guaranteed with full function reliability approved.

Features

- Advanced high cell density Trench technology
- Super Low Gate Charge
- Excellent CdV/dt effect decline
- 100% E_{AS} Guaranteed
- Green Device Available

Product Summary

BV_{DSS}	$R_{DS(ON)}$	I_D
40V	4.5m Ω	68A

Applications

- High Frequency Point-of-Load Synchronous Buck Converter for MB/NB/UMPC/VGA
- Networking DC-DC Power System
- Load Switch

DFN3X3-8L Pin Configuration

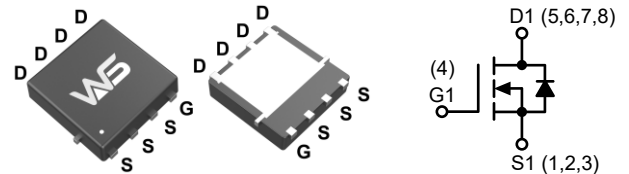

Absolute Maximum Ratings

Symbol	Parameter	Rating	Units
V_{DS}	Drain-Source Voltage	40	V
V_{GS}	Gate-Source Voltage	± 20	
$I_D@T_C=25^\circ C$	Continuous Drain Current, $V_{GS} @ 10V^7$	68	A
$I_D@T_C=100^\circ C$	Continuous Drain Current, $V_{GS} @ 10V^7$	35	
$I_{DM}@T_C=25^\circ C$	Pulsed Drain Current ³	144	
E_{AS}	Avalanche Energy, Single Pulse (L=0.3mH)	80	mJ
I_{AS}	Avalanche Current	40	A
$P_D@T_A=25^\circ C$	Total Power Dissipation ¹	3.1	W
$P_D@T_A=70^\circ C$	Total Power Dissipation ¹	2.0	
T_{STG}	Storage Temperature Range	-55 to 150	$^\circ C$
T_J	Operating Junction Temperature Range	-55 to 150	

Thermal Data

Symbol	Parameter	Typ.	Max.	Units
$R_{\theta JA}$	Thermal Resistance, Junction-to-Ambient ¹	---	60	$^\circ C/W$
$R_{\theta JC}$	Thermal Resistance, Junction-to-Case ¹	---	2.8	

Electrical Characteristics (T_J=25°C, Unless Otherwise Noted)

Symbol	Parameter	Conditions	Min.	Typ.	Max.	Units
BV _{DSS}	Drain-Source Breakdown Voltage	V _{GS} =0V, I _D =250μA	40	---	---	V
R _{DS(ON)}	Static Drain-Source On-Resistance ²	V _{GS} =10V, I _D =7A	---	4.5	5.5	mΩ
		V _{GS} =4.5V, I _D =5A	---	5.3	7.6	
V _{GS(th)}	Gate Threshold Voltage	V _{GS} =V _{DS} , I _D =250μA	1.4	1.9	2.4	V
ΔV _{GS(th)}	V _{GS(th)} Temperature Coefficient		---	-6.06	---	mV/°C
I _{DSS}	Drain-Source Leakage Current	V _{DS} =40V, V _{GS} =0V, T _J =25°C	---	---	2.0	μA
		V _{DS} =40V, V _{GS} =0V, T _J =55°C	---	---	10	
I _{GSS}	Gate-Source Leakage Current	V _{GS} =±20V, V _{DS} =0V	---	---	±100	nA
g _{fs}	Forward Transconductance	V _{DS} =5V, I _D =20A	---	67	---	S
R _g	Gate Resistance	V _{DS} =0V, V _{GS} =0V, f = 1.0MHz	---	0.8	1.5	Ω
Q _g	Total Gate Charge (10V)	V _{DS} =20V, V _{GS} =10V, I _{DS} =20A	---	28	---	nC
Q _{gs}	Gate-Source Charge		---	3.9	---	
Q _{gd}	Gate-Drain Charge		---	6.0	---	
T _{d(on)}	Turn-On Delay Time	V _{DS} =20V, V _{GS} =10V, R _G =3Ω, R _L =1Ω	---	7.2	---	ns
T _r	Rise Time		---	3.0	---	
T _{d(off)}	Turn-Off Delay Time		---	23	---	
T _f	Fall Time		---	3.5	---	
C _{iss}	Input Capacitance	V _{DS} =20V, V _{GS} =0V, f = 1.0MHz	---	2420	---	pF
C _{oss}	Output Capacitance		---	220	---	
C _{rss}	Reverse Transfer Capacitance		---	150	---	

Note:

- The value of R_{θJA} is measured with the device mounted on 1in² FR-4 board with 2oz. Copper, in a still air environment with T_A=25°C. The Power dissipation P_{DSM} is based on R_{θJA} ≤10s and the maximum allowed junction temperature of 150°C. The value in any given application depends on the user's specific board design, and the maximum temperature of 150°C may be used if the PCB allows it.
- The power dissipation P_D is based on T_{J(MAX)}=150°C, using junction-to-case thermal resistance, and is more useful in setting the upper dissipation limit for cases where additional heatsinking is used.
- Repetitive rating, pulse width limited by junction temperature T_{J(MAX)}=150°C. Ratings are based on low frequency and duty cycles to keep initial T_J=25°C.
- The R_{θJA} is the sum of the thermal impedance from junction to case R_{θJC} and case to ambient.
- The static characteristics in Figures 1 to 6 are obtained using <300μs pulses, duty cycle 0.5% max.
- These curves are based on the junction-to-case thermal impedance which is measured with the device mounted to a large heatsink, assuming a maximum junction temperature of T_{J(MAX)}=150°C. The SOA curve provides a single pulse rating.
- The maximum current rating is package limited.
- These tests are performed with the device mounted on 1 in² FR-4 board with 2oz. Copper, in a still air environment with T_A=25°C.

Typical Characteristics

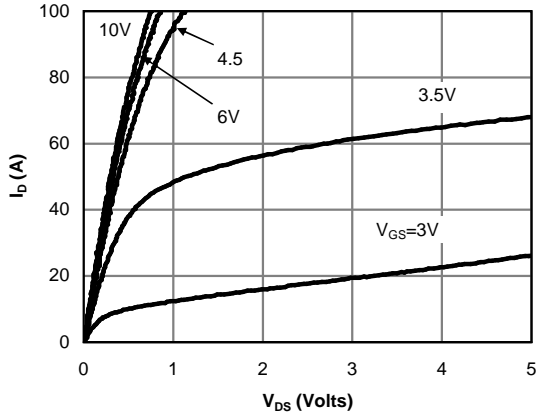

Fig 1: On-Region Characteristics (Note E)

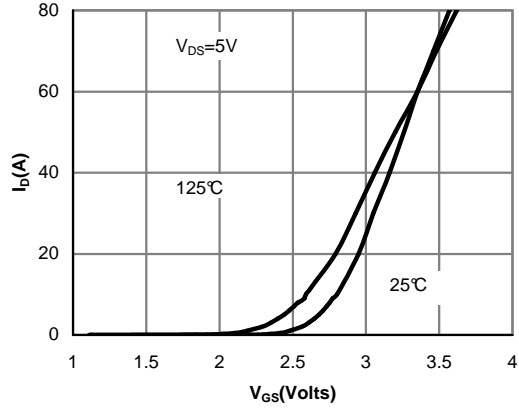

Figure 2: Transfer Characteristics (Note E)

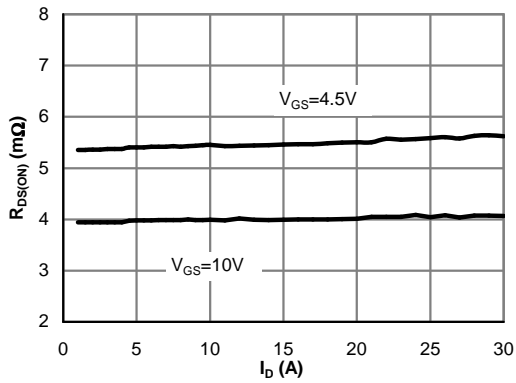

Figure 3: On-Resistance vs. Drain Current and Gate Voltage (Note E)

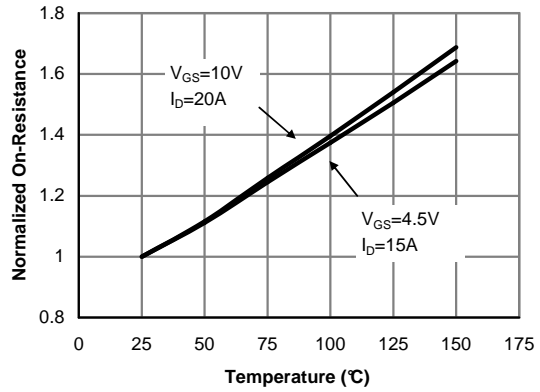

Figure 4: On-Resistance vs. Junction Temperature (Note E)

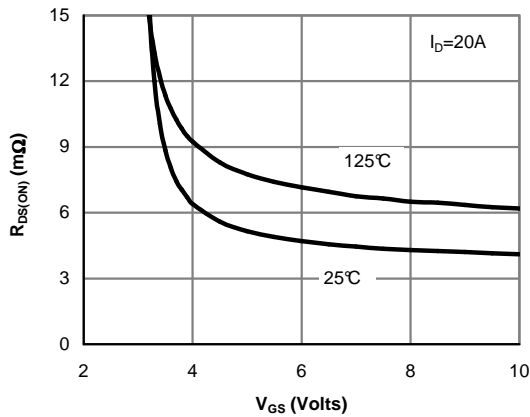

Figure 5: On-Resistance vs. Gate-Source Voltage (Note E)

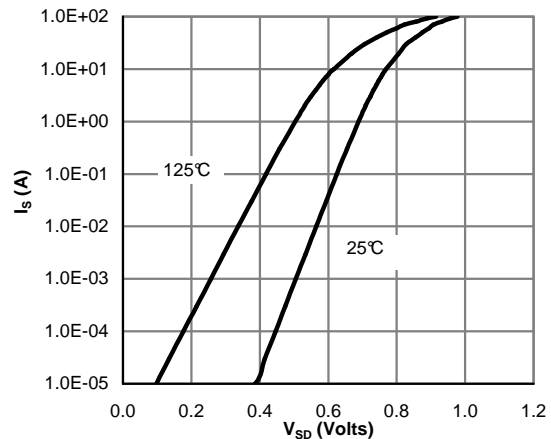

Figure 6: Body-Diode Characteristics (Note E)

Typical Characteristics (Cont.)

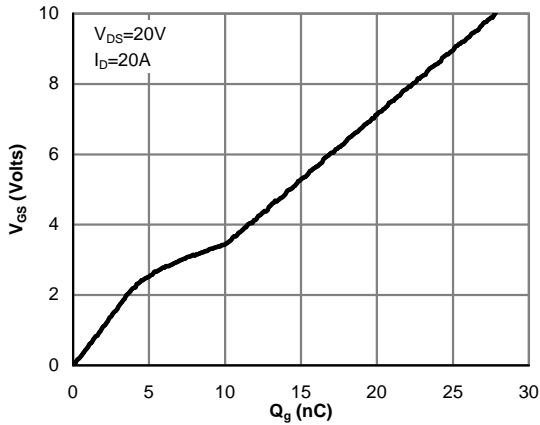

Figure 7: Gate-Charge Characteristics

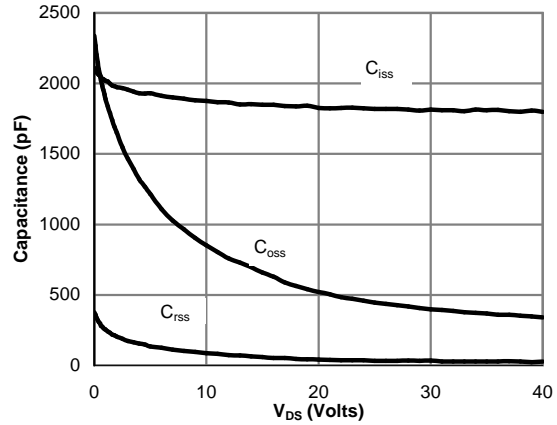

Figure 8: Capacitance Characteristics

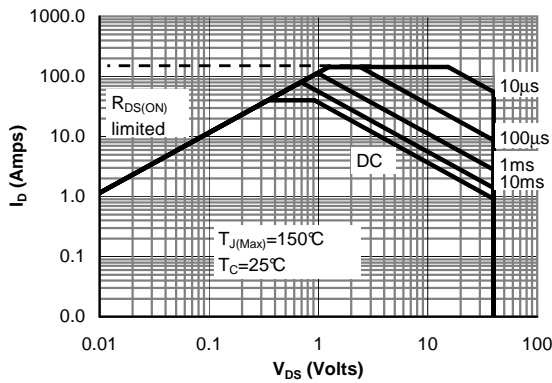

Figure 9: Maximum Forward Biased Safe Operating Area (Note F)

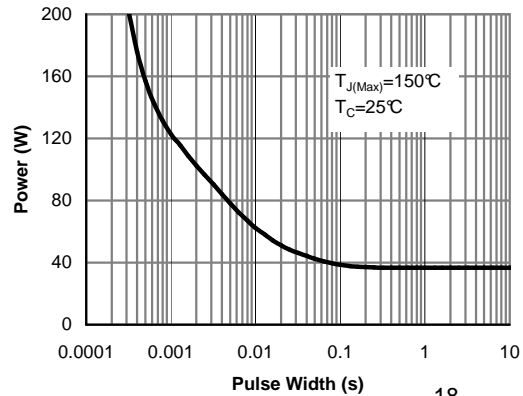

Figure 10: Single Pulse Power Rating Junction-to-Case (Note F)

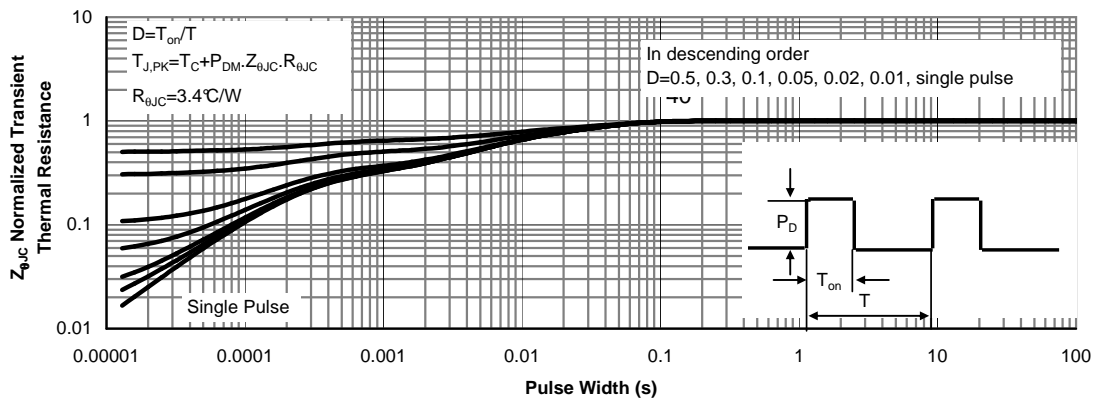

Figure 11: Normalized Maximum Transient Thermal Impedance (Note F)

Typical Characteristics (Cont.)

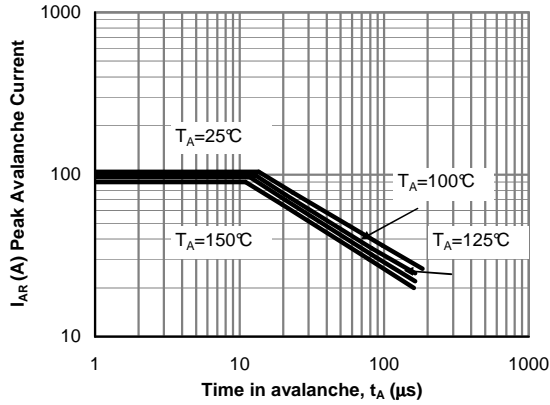

Figure 12: Single Pulse Avalanche capability (Note C)

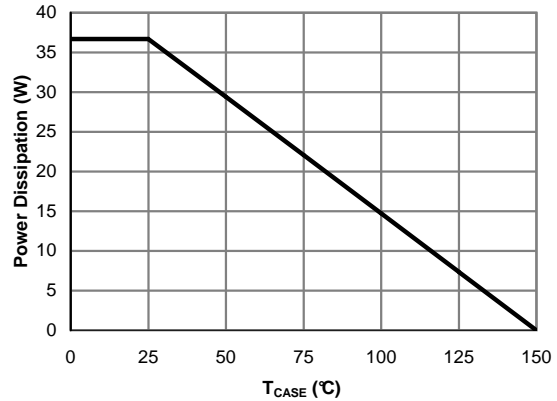

Figure 13: Power De-rating (Note F)

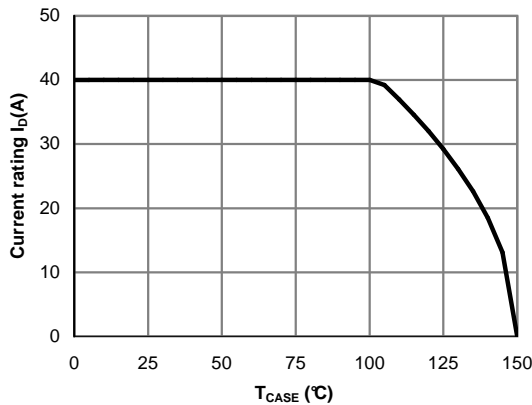

Figure 14: Current De-rating (Note F)

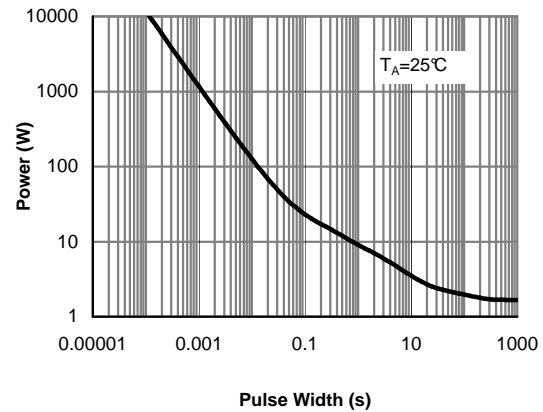

Figure 15: Single Pulse Power Rating Junction-to-Ambient (Note H)

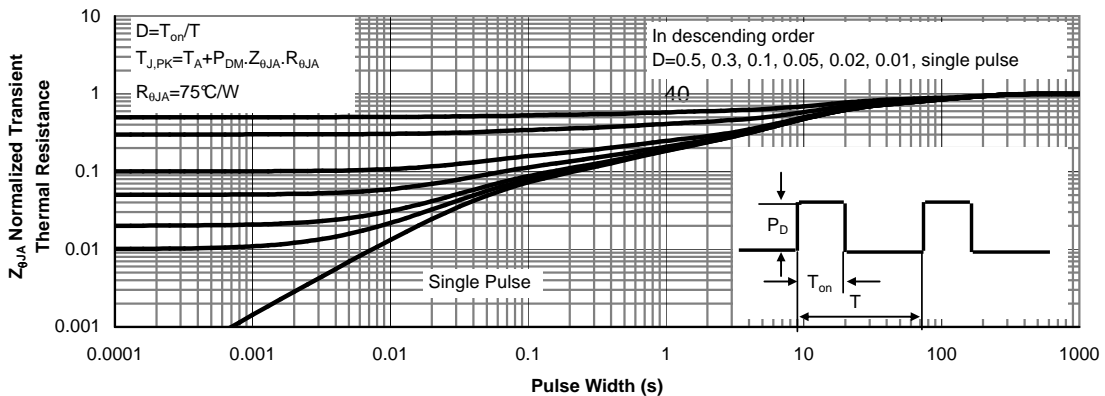
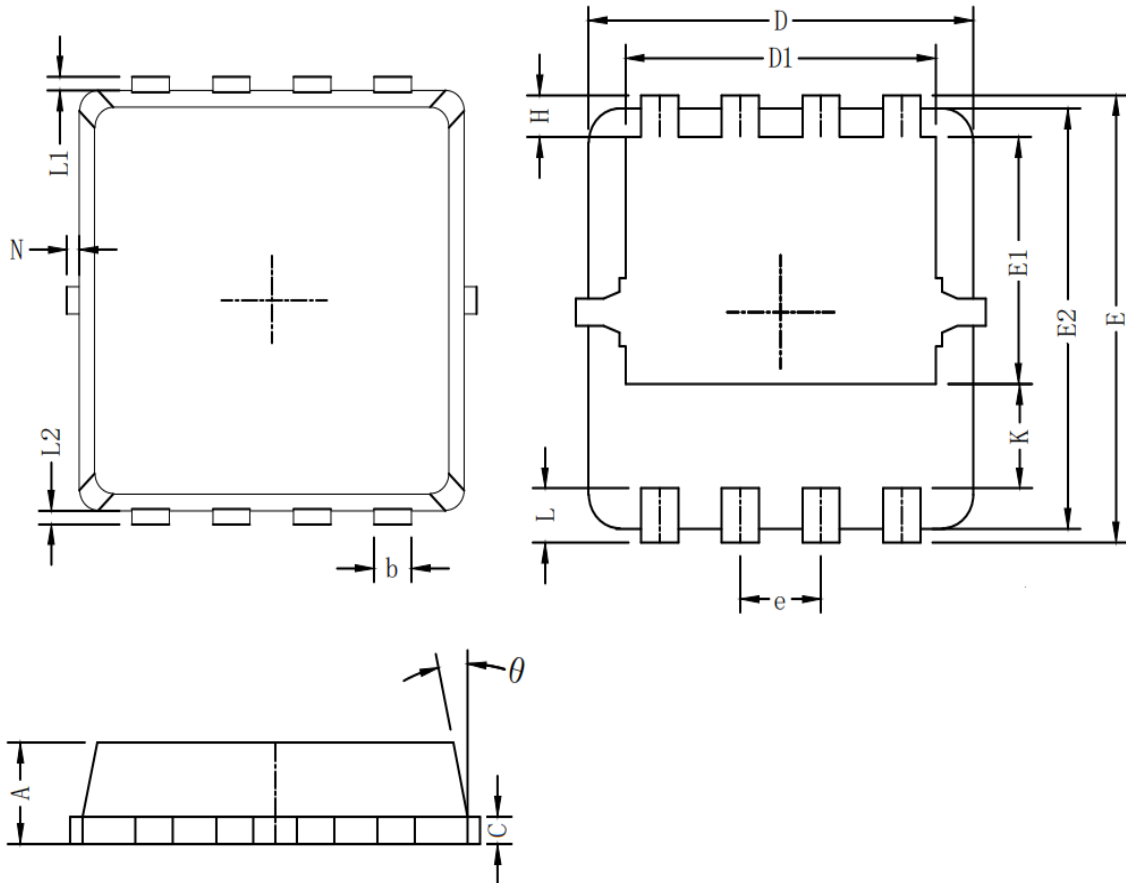

Figure 16: Normalized Maximum Transient Thermal Impedance (Note H)

Packaging information

Symbol	Dim in mm		
	min	typ	max
A	0.6	0.75	0.9
b	0.2	0.3	0.4
C	0.15	0.2	0.25
D	3	3.1	3.2
D1	2.3	2.45	2.6
E	3.15	3.3	3.45
E1	1.43	1.73	1.93
E2	2.9	3.05	3.2
e	0.65BSC		
H	0.2	0.35	0.5
K	0.57	0.77	0.87
L	0.3	0.4	0.5
L1/L2	0.1REF		
θ	8°	10°	13°
N	0		0.15

Attention

1, Any and all Winsok power products described or contained herein do not have specifications that can handle applications that require extremely high levels of reliability, such as life-support systems, aircraft's control systems, or other applications whose failure can be reasonably expected to result in serious physical and/or material damage. Consult with your Winsok power representative nearest you before using any Winsok power products described or contained herein in such applications.

2, Winsok power assumes no responsibility for equipment failures that result from using products at values that exceed, even momentarily, rated values (such as maximum ratings, operating condition ranges, or other parameters) listed in products specifications of any and all Winsok power products described or contained herein.

3, Specifications of any and all Winsok power products described or contained herein stipulate the performance, characteristics, and functions of the described products in the independent state, and are not guarantees of the performance, characteristics, and functions of the described products as mounted in the customer's products or equipment. To verify symptoms and states that cannot be evaluated in an independent device, the customer should always evaluate and test devices mounted in the customer's products or equipment.

4, Winsok power Semiconductor CO., LTD. strives to supply high-quality high-reliability products. However, any and all semiconductor products fail with some probability. It is possible that these probabilistic failures could give rise to accidents or events that could endanger human lives that could give rise to smoke or fire, or that could cause damage to other property. When designing equipment, adopt safety measures so that these kinds of accidents or events cannot occur. Such measures include but are not limited to protective circuits and error prevention circuits for safe design, redundant design, and structural design.

5, In the event that any or all Winsok power products(including technical data, services) described or contained herein are controlled under any of applicable local export control laws and regulations, such products must not be exported without obtaining the export license from the authorities concerned in accordance with the above law.

6, No part of this publication may be reproduced or transmitted in any form or by any means, electronic or mechanical, including photocopying and recording, or any information storage or retrieval system, or otherwise, without the prior written permission of Winsok power Semiconductor CO., LTD.

7, Information (including circuit diagrams and circuit parameters) herein is for example only; it is not guaranteed for volume production. Winsok power believes information herein is accurate and reliable, but no guarantees are made or implied regarding its use or any infringements of intellectual property rights or other rights of third parties.

8, Any and all information described or contained herein are subject to change without notice due to product/technology improvement,etc. When designing equipment, refer to the "Delivery Specification" for the Winsok power product that you intend to use.

9, this catalog provides information as of Sep.2014. Specifications and information herein are subject to change without notice.