



General Description

This product family offers state of the art performance. It is designed for high frequency applications where high efficiency and high reliability are required.

Features

- Low conduction loss due to low V_F
- Extremely low switching loss by tiny Q_c
- Highly rugged due to better surge current
- Industrial standard quality and reliability

Applications

- UPS
- Power Inverter
- High performance SMPS
- Power factor correction

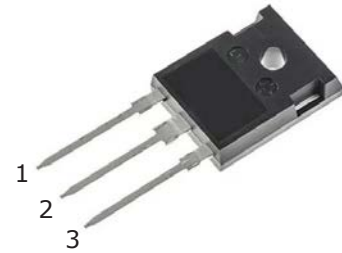

TO-247
Package

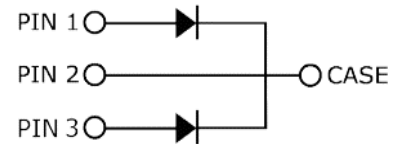

Ordering Part Number	Package	Marking
HC3D16065D	TO-247	HC3D16065D





Maximum Ratings (at $T_j = 25^\circ\text{C}$, unless otherwise specified)

Parameter	Symbol	Value	Unit
Repetitive Peak Reverse Voltage	V_{RRM}	650	V
Surge Peak Reverse Voltage	V_{RSM}	650	V
DC Peak Reverse Voltage	V_R	650	V
Continuous Forward Current $T_c = 25^\circ\text{C}$ $T_c = 135^\circ\text{C}$ $T_c = 160^\circ\text{C}$	I_F	28/56 13/26 8/16	A
Repetitive Peak Forward Surge Current $T_c = 25^\circ\text{C}, t_p=10\text{ms}, \text{Half Sine Pulse}$ $T_c = 110^\circ\text{C}, t_p=10\text{ms}, \text{Half Sine Pulse}$	I_{FRM}	35 21	A
Non-Repetitive Forward Surge Current $T_c = 25^\circ\text{C}, t_p=10\text{ms}, \text{Half Sine Pulse}$ $T_c = 110^\circ\text{C}, t_p=10\text{ms}, \text{Half Sine Pulse}$	I_{FSM}	65 55	A
i^2dt value $T_c = 25^\circ\text{C}, t_p=10\text{ms}, \text{Half Sine Pulse}$ $T_c = 110^\circ\text{C}, t_p=10\text{ms}, \text{Half Sine Pulse}$	$\int i^2dt$	21 15	A^2s
Power dissipation $T_c = 25^\circ\text{C}$ $T_c = 110^\circ\text{C}$	P_{tot}	100/200 43/86	W
Operating junction Range	T_j	-55 to +175	$^\circ\text{C}$
Storage temperature Range	T_{stg}	-55 to +150	$^\circ\text{C}$

Thermal Resistance

Parameter	Symbol	Value	Unit
Thermal resistance, junction – case.	R_{thJC}	1.5/0.75	$^\circ\text{C/W}$



Electrical Characteristic (at $T_j = 25^\circ\text{C}$, unless otherwise specified)

Parameter	Symbol	Value			Unit	Test Condition
		min.	typ.	max.		
Forward Voltage	V_F	-	1.3	1.5	V	$I_F=16\text{A}$ $T_j=25^\circ\text{C}$
		-	1.55	1.8		$T_j=175^\circ\text{C}$
Reverse Current	I_R	-	1	24	μA	$V_R=650\text{V}$ $T_j=25^\circ\text{C}$
		-	3	64		$T_j=175^\circ\text{C}$
Total Capacitive Charge	Q_C	-	22	-	nC	$V_R=400\text{V}, T_j=25^\circ\text{C}$ $Q_C = \int_0^{V_R} C(V)dV$
Total Capacitance	C	-	394	-	pF	$T_j=25^\circ\text{C}, f=1\text{MHz}$ $V_R=0\text{V}$
		-	41	-		$V_R=200\text{V}$
		-	34	-		$V_R=400\text{V}$

Characteristics Curve:

Fig 1: Forward Characteristics

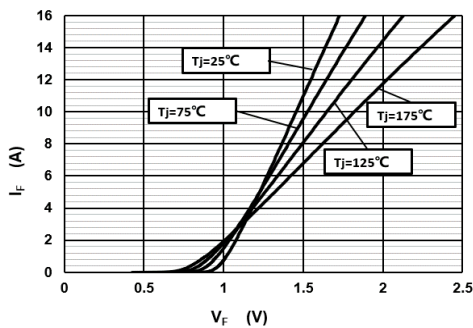

Fig 2: Reverse Characteristics

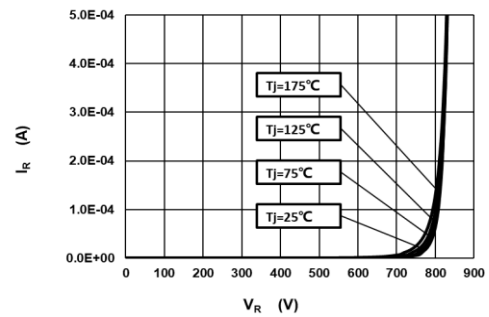

Fig 3: Current Derating

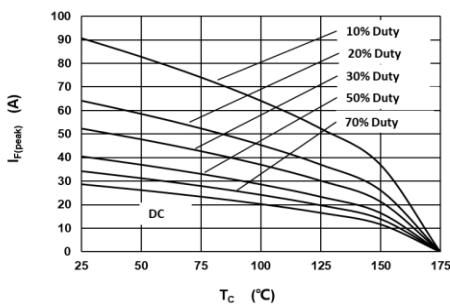

Fig 4: Power Derating

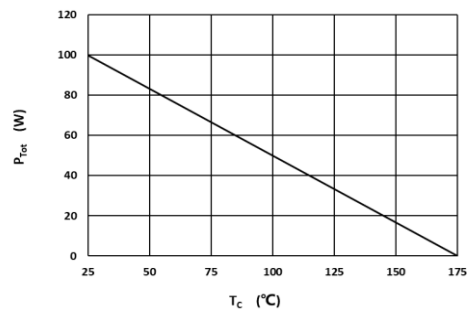



Fig 5: Capacitance vs. Reverse Voltage

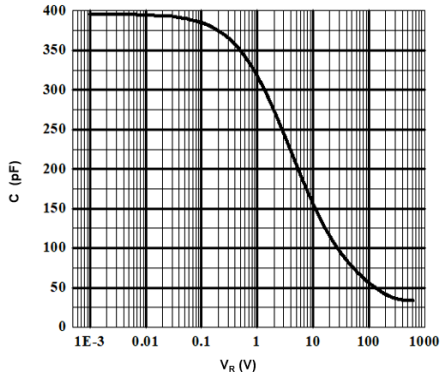

Fig 6: Reverse Charge vs. Reverse Voltage

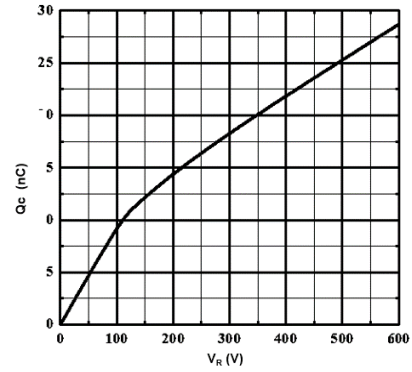

Fig 7: Typical Capacitance Stored Energy

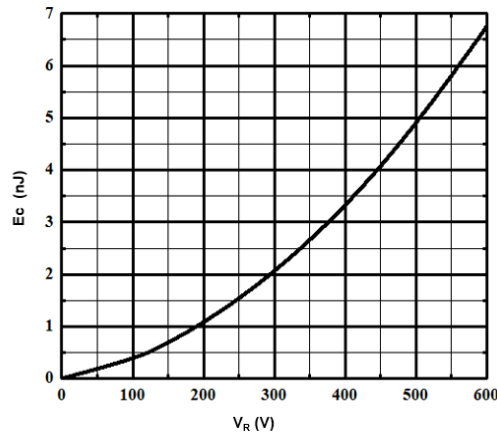
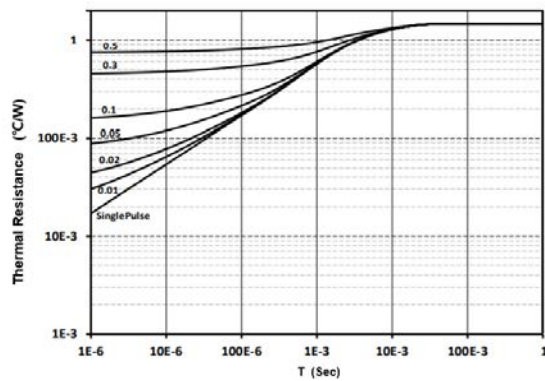

Fig 8: Transient Thermal Impandance





Package Dimensions

Package TO-247

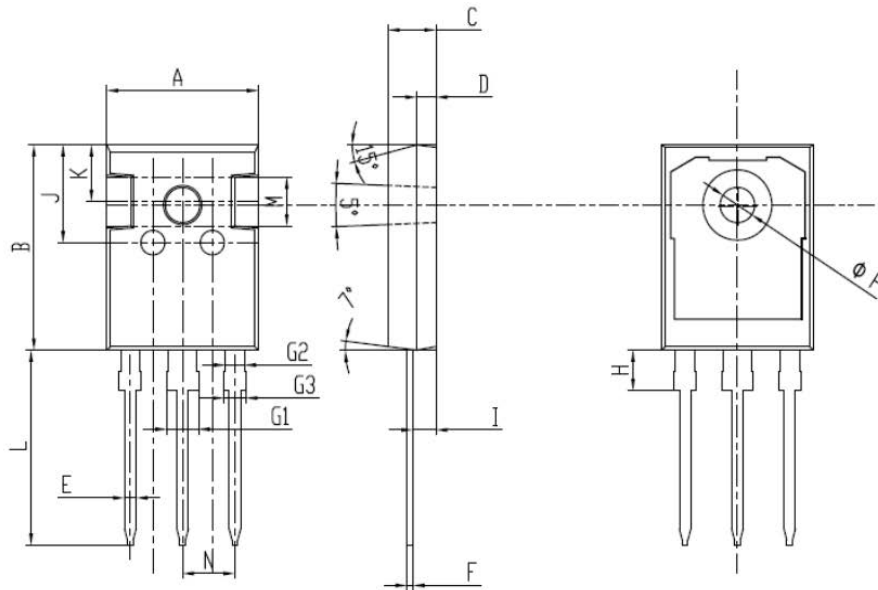

项目	规范(mm)	
	MIN	MAX
A	15.70	15.90
B	20.90	21.10
C	4.90	5.10
D	1.90	2.10
E	1.10	1.30
F	0.45	0.75
G1	3.00	3.20
G2	1.85	2.15
G3	2.00	2.20
H	4.00	4.30
I	2.30	2.50
J	9.90	10.10
K	5.70	5.90
L	19.80	20.20
M	4.85	5.15
N	5.286	5.586
ϕP	3.40	3.60



Attention

- Any and all HUA XUAN YANG ELECTRONICS products described or contained herein do not have specifications that can handle applications that require extremely high levels of reliability, such as life-support systems, aircraft's control systems, or other applications whose failure can be reasonably expected to result in serious physical and/or material damage. Consult with your HUA XUAN YANG ELECTRONICS representative nearest you before using any HUA XUAN YANG ELECTRONICS products described or contained herein in such applications.

- HUA XUAN YANG ELECTRONICS assumes no responsibility for equipment failures that result from using products at values that exceed, even momentarily, rated values (such as maximum ratings, operating condition ranges, or other parameters) listed in products specifications of any and all HUA XUAN YANG ELECTRONICS products described or contained herein.

- Specifications of any and all HUA XUAN YANG ELECTRONICS products described or contained herein stipulate the performance, characteristics, and functions of the described products in the independent state, and are not guarantees of the performance, characteristics, and functions of the described products as mounted in the customer's products or equipment. To verify symptoms and states that cannot be evaluated in an independent device, the customer should always evaluate and test devices mounted in the customer's products or equipment.

- HUA XUAN YANG ELECTRONICS CO.,LTD. strives to supply high-quality high-reliability products. However, any and all semiconductor products fail with some probability. It is possible that these probabilistic failures could give rise to accidents or events that could endanger human lives, that could give rise to smoke or fire, or that could cause damage to other property. When designing equipment, adopt safety measures so that these kinds of accidents or events cannot occur. Such measures include but are not limited to protective circuits and error prevention circuits for safe design, redundant design, and structural design.

- In the event that any or all HUA XUAN YANG ELECTRONICS products(including technical data, services) described or contained herein are controlled under any of applicable local export control laws and regulations, such products must not be exported without obtaining the export license from the authorities concerned in accordance with the above law.

- No part of this publication may be reproduced or transmitted in any form or by any means, electronic or mechanical, including photocopying and recording, or any information storage or retrieval system, or otherwise, without the prior written permission of HUA XUAN YANG ELECTRONICS CO.,LTD.

- Information (including circuit diagrams and circuit parameters) herein is for example only ; it is not guaranteed for volume production. HUA XUAN YANG ELECTRONICS believes information herein is accurate and reliable, but no guarantees are made or implied regarding its use or any infringements of intellectual property rights or other rights of third parties.

- Any and all information described or contained herein are subject to change without notice due to product/technology improvement, etc. When designing equipment, refer to the "Delivery Specification" for the HUA XUAN YANG ELECTRONICS product that you intend to use.