

BGU7005

SiGe:C Low Noise Amplifier MMIC for GPS, GLONASS, Galileo and Compass

Rev. 6 — 18 January 2017

Product data sheet

1. Product profile

1.1 General description

The BGU7005 is, also known as the GPS1101M, a Low Noise Amplifier (LNA) for GNSS receiver applications in a plastic leadless 6-pin, extremely small SOT886 package. The BGU7005 requires only one external matching inductor and one external decoupling capacitor.

The BGU7005 adapts itself to the changing environment resulting from co-habitation of different radio systems in modern cellular handsets. It has been designed for low power consumption and optimal performance when jamming signals from co-existing cellular transmitters are present. At low jamming power levels it delivers 16.5 dB gain at a noise figure of 0.85 dB. During high jamming power levels, resulting for example from a cellular transmit burst, it temporarily increases its bias current to improve sensitivity.

CAUTION



This device is sensitive to ElectroStatic Discharge (ESD). Therefore care should be taken during transport and handling.

1.2 Features and benefits

- Covers full GNSS L1 band, from 1559 MHz to 1610 MHz
- Noise figure (NF) = 0.85 dB
- Gain 16.5 dB
- High input 1 dB compression point $P_{i(1dB)}$ of -11 dBm
- High out of band $IP3_i$ of 9 dBm
- Supply voltage 1.5 V to 3.1 V
- Power-down mode current consumption < 1 μ A
- Optimized performance at low supply current of 4.5 mA
- Integrated matching for the output
- Requires only one input matching inductor and one supply decoupling capacitor
- Input and output DC decoupled
- ESD protection on all pins (HBM > 2 kV)
- Integrated temperature stabilized bias for easy design
- Small 6-pin leadless package 1 mm \times 1.45 mm \times 0.5 mm
- 110 GHz transit frequency - SiGe:C technology



1.3 Applications

- LNA for GPS, GLONASS, Galileo and Compass (BeiDou) in smart phones, feature phones, tablet PCs, Personal Navigation Devices, Digital Still Cameras, Digital Video Cameras, RF Front End modules, complete GPS chipset modules and theft protection (laptop, ATM).

1.4 Quick reference data

Table 1. Quick reference data

$f = 1559\text{ MHz to }1610\text{ MHz}$; $V_{CC} = 1.8\text{ V}$; $P_i < -40\text{ dBm}$; $T_{amb} = 25\text{ }^\circ\text{C}$; input matched to $50\ \Omega$ using a 5.6 nH inductor; unless otherwise specified.

Symbol	Parameter	Conditions	Min	Typ	Max	Unit	
V_{CC}	supply voltage	RF input AC coupled	1.5	-	3.1	V	
I_{CC}	supply current	$V_{ENABLE} \geq 0.8\text{ V}$					
		$P_i < -40\text{ dBm}$	3.2	4.5	5.7	mA	
		$P_i = -20\text{ dBm}$	8.1	11.6	14.4	mA	
G_p	power gain	$P_i < -40\text{ dBm}$, no jammer	14	16.5	19	dB	
		$P_i = -20\text{ dBm}$, no jammer	15	17.5	20	dB	
NF	noise figure	$P_i < -40\text{ dBm}$, no jammer	[1]	-	0.85	1.2	dB
		$P_i < -40\text{ dBm}$, no jammer	[2]	-	0.9	1.3	dB
		$P_i = -20\text{ dBm}$, no jammer	-	1.2	1.6	dB	
$P_{i(1dB)}$	input power at 1 dB gain compression	$f = 1575\text{ MHz}$					
		$V_{CC} = 1.5\text{ V}$	-15	-12	-	dBm	
		$V_{CC} = 1.8\text{ V}$	-14	-11	-	dBm	
		$V_{CC} = 2.85\text{ V}$	-11	-8	-	dBm	
IP3 _i	input third-order intercept point	$f = 1.575\text{ GHz}$					
		$V_{CC} = 1.5\text{ V}$	[3]	5	8	-	dBm
		$V_{CC} = 1.8\text{ V}$	[3]	5	9	-	dBm
		$V_{CC} = 2.85\text{ V}$	[3]	5	12	-	dBm

[1] PCB losses are subtracted.

[2] Including PCB losses.

[3] $f_1 = 1713\text{ MHz}$; $f_2 = 1851\text{ MHz}$; $P_1 = P_2 = -30\text{ dBm}$.

2. Pinning information

Table 2. Pinning

Pin	Description	Simplified outline	Graphic symbol
1	GND		
2	GND		
3	RF_IN		
4	V_{CC}		
5	ENABLE		
6	RF_OUT		

3. Ordering information

Table 3. Ordering information

Type number	Package		Version
	Name	Description	
BGU7005	XSON6	plastic extremely thin small outline package; no leads; 6 terminals; body 1 × 1.45 × 0.5 mm	SOT886

4. Marking

Table 4. Marking codes

Type number	Marking code
BGU7005	AC

5. Limiting values

Table 5. Limiting values

In accordance with the Absolute Maximum Rating System (IEC 60134).

Symbol	Parameter	Conditions	Min	Max	Unit	
V_{CC}	supply voltage	RF input AC coupled	-0.5	5.0	V	
V_{ENABLE}	voltage on pin ENABLE	$V_{ENABLE} < V_{CC} + 0.6$	[2]	-0.5	5.0	V
V_{RF_IN}	voltage on pin RF_IN	DC; $V_{RF_IN} < V_{CC} + 0.6$	[2][3]	-0.5	5.0	V
V_{RF_OUT}	voltage on pin RF_OUT	DC; $V_{RF_OUT} < V_{CC} + 0.6$	[2][3]	-0.5	5.0	V
P_i	input power		-	0	dBm	
P_{tot}	total power dissipation	$T_{sp} \leq 130$ °C	[1]	55	mW	
T_{stg}	storage temperature		-65	150	°C	
T_j	junction temperature		-	150	°C	
V_{ESD}	electrostatic discharge voltage	Human Body Model (HBM); According JEDEC standard 22-A114E	-	4	kV	
		Charged Device Model (CDM); According JEDEC standard 22-C101B	-	1	kV	

[1] T_{sp} is the temperature at the soldering point of the emitter lead.

[2] Warning: due to internal ESD diode protection, the applied DC voltage should not exceed $V_{CC} + 0.6$ and shall not exceed 5.0 V in order to avoid excess current.

[3] The RF input and RF output are AC coupled through internal DC blocking capacitor.

6. Thermal characteristics

Table 6. Thermal characteristics

Symbol	Parameter	Conditions	Typ	Unit
$R_{th(j-sp)}$	thermal resistance from junction to solder point		225	K/W

7. Characteristics

Table 7. Characteristics

$f = 1559\text{ MHz to }1610\text{ MHz}$; $V_{CC} = 1.8\text{ V}$; $V_{ENABLE} \geq 0.8\text{ V}$; $P_i < -40\text{ dBm}$; $T_{amb} = 25\text{ }^\circ\text{C}$; input matched to $50\text{ }\Omega$ using a 5.6 nH inductor; unless otherwise specified.

Symbol	Parameter	Conditions	Min	Typ	Max	Unit	
V_{CC}	supply voltage	RF input AC coupled	1.5	-	3.1	V	
I_{CC}	supply current	$V_{ENABLE} \geq 0.8\text{ V}$					
		$P_i < -40\text{ dBm}$	3.2	4.5	5.7	mA	
		$P_i = -20\text{ dBm}$	8.1	11.6	14.4	mA	
		$V_{ENABLE} \leq 0.35\text{ V}$	-	-	1	μA	
T_{amb}	ambient temperature		-40	+25	+85	$^\circ\text{C}$	
G_p	power gain	$T_{amb} = 25\text{ }^\circ\text{C}$					
		$P_i < -40\text{ dBm}$, no jammer	14	16.5	19	dB	
		$P_i = -20\text{ dBm}$, no jammer	15	17.5	20	dB	
		$P_{jam} = -20\text{ dBm}$; $f_{jam} = 850\text{ MHz}$	15	17.5	20	dB	
		$P_{jam} = -20\text{ dBm}$; $f_{jam} = 1850\text{ MHz}$	15	17.5	20	dB	
		$-40\text{ }^\circ\text{C} \leq T_{amb} \leq +85\text{ }^\circ\text{C}$					
		$P_i < -40\text{ dBm}$, no jammer	13	-	20	dB	
		$P_i = -20\text{ dBm}$, no jammer	14	-	21	dB	
		$P_{jam} = -20\text{ dBm}$; $f_{jam} = 850\text{ MHz}$	14	-	21	dB	
		$P_{jam} = -20\text{ dBm}$; $f_{jam} = 1850\text{ MHz}$	14	-	21	dB	
RL_{in}	input return loss	$P_i < -40\text{ dBm}$	5	8	-	dB	
		$P_i = -20\text{ dBm}$	6	10	-	dB	
RL_{out}	output return loss	$P_i < -40\text{ dBm}$	10	20	-	dB	
		$P_i = -20\text{ dBm}$	10	14	-	dB	
ISL	isolation		20	23	-	dB	
NF	noise figure	$T_{amb} = 25\text{ }^\circ\text{C}$					
		$P_i < -40\text{ dBm}$, no jammer	1	-	0.85	1.2	dB
		$P_i < -40\text{ dBm}$, no jammer	2	-	0.9	1.3	dB
		$P_i = -20\text{ dBm}$, no jammer	-	-	1.2	1.6	dB
		$P_{jam} = -20\text{ dBm}$; $f_{jam} = 850\text{ MHz}$	-	-	1.1	1.5	dB
		$P_{jam} = -20\text{ dBm}$; $f_{jam} = 1850\text{ MHz}$	-	-	1.3	1.7	dB
		$-40\text{ }^\circ\text{C} \leq T_{amb} \leq +85\text{ }^\circ\text{C}$					
		$P_i < -40\text{ dBm}$, no jammer	-	-	1.7	dB	
		$P_i = -20\text{ dBm}$, no jammer	-	-	1.9	dB	
		$P_{jam} = -20\text{ dBm}$; $f_{jam} = 850\text{ MHz}$	-	-	1.8	dB	
		$P_{jam} = -20\text{ dBm}$; $f_{jam} = 1850\text{ MHz}$	-	-	2.0	dB	

Table 7. Characteristics ...continued

$f = 1559 \text{ MHz to } 1610 \text{ MHz}$; $V_{CC} = 1.8 \text{ V}$; $V_{ENABLE} \geq 0.8 \text{ V}$; $P_i < -40 \text{ dBm}$; $T_{amb} = 25 \text{ }^\circ\text{C}$; input matched to $50 \text{ } \Omega$ using a 5.6 nH inductor; unless otherwise specified.

Symbol	Parameter	Conditions	Min	Typ	Max	Unit	
$P_{i(1dB)}$	input power at 1 dB gain compression	$f = 1575 \text{ MHz}$					
		$V_{CC} = 1.5 \text{ V}$	-15	-12	-	dBm	
		$V_{CC} = 1.8 \text{ V}$	-14	-11	-	dBm	
		$V_{CC} = 2.85 \text{ V}$	-11	-8	-	dBm	
		$f = 806 \text{ MHz to } 928 \text{ MHz}$					
		$V_{CC} = 1.5 \text{ V}$	[3]	-15	-12	-	dBm
		$V_{CC} = 1.8 \text{ V}$	[3]	-14	-11	-	dBm
		$V_{CC} = 2.85 \text{ V}$	[3]	-14	-11	-	dBm
		$f = 1612 \text{ MHz to } 1909 \text{ MHz}$					
$IP3_i$	input third-order intercept point	$f = 1.575 \text{ GHz}$					
		$V_{CC} = 1.5 \text{ V}$	[4]	5	8	-	dBm
		$V_{CC} = 1.8 \text{ V}$	[4]	5	9	-	dBm
		$V_{CC} = 2.85 \text{ V}$	[4]	5	12	-	dBm
t_{on}	turn-on time		[5]	-	-	2 μs	
t_{off}	turn-off time		[5]	-	-	1 μs	
K	Rollett stability factor		1	-	-		

- [1] PCB losses are subtracted.
- [2] Including PCB losses.
- [3] Out of band.
- [4] $f_1 = 1713 \text{ MHz}$; $f_2 = 1851 \text{ MHz}$; $P_1 = P_2 = -30 \text{ dBm}$.
- [5] Within 10 % of the final gain.

Table 8. ENABLE (pin 5)

$-40 \text{ }^\circ\text{C} \leq T_{amb} \leq +85 \text{ }^\circ\text{C}$; $1.5 \text{ V} \leq V_{CC} \leq 3.1 \text{ V}$

$V_{ENABLE} \text{ (V)}$	State
≤ 0.35	OFF
≥ 0.8	ON

8. Application information

8.1 GNSS LNA

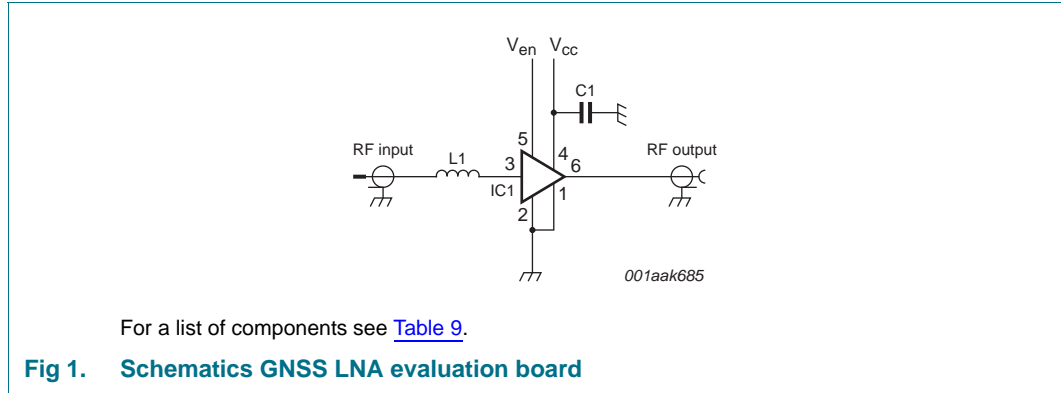
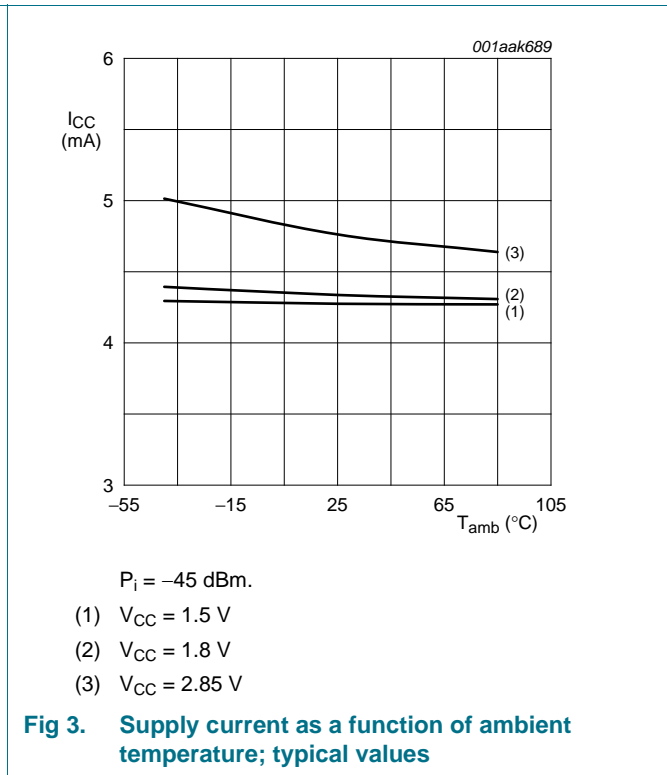
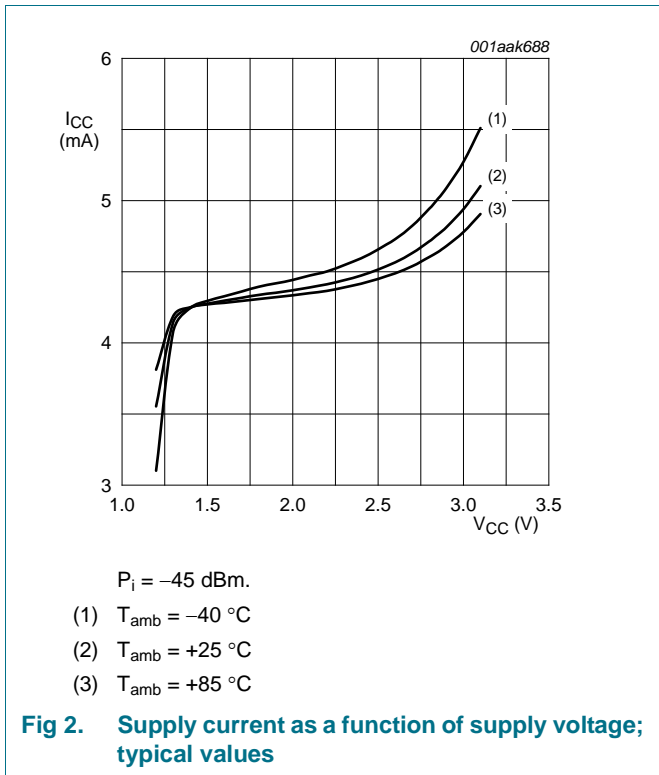
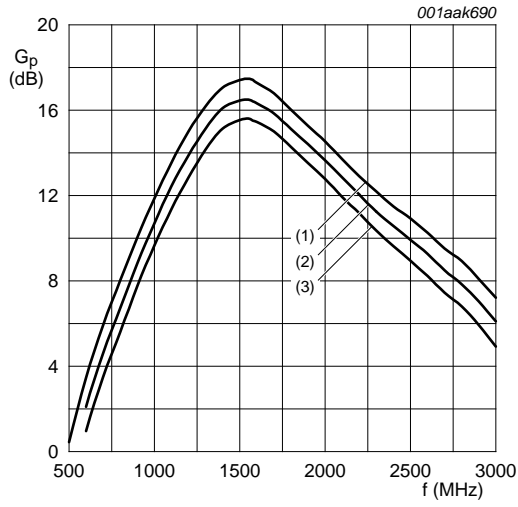

Table 9. List of components

For schematics see [Figure 1](#).

Component	Description	Value	Supplier	Remarks
C1	decoupling capacitor	1 nF	various	
IC1	BGU7005	-	NXP	
L1	high quality matching inductor	5.6 nH	Murata LQW15A	





$V_{CC} = 1.8\text{ V}; P_i = -45\text{ dBm}$.
 (1) $T_{amb} = -40\text{ }^\circ\text{C}$
 (2) $T_{amb} = +25\text{ }^\circ\text{C}$
 (3) $T_{amb} = +85\text{ }^\circ\text{C}$

Fig 4. Power gain as a function of frequency; typical values

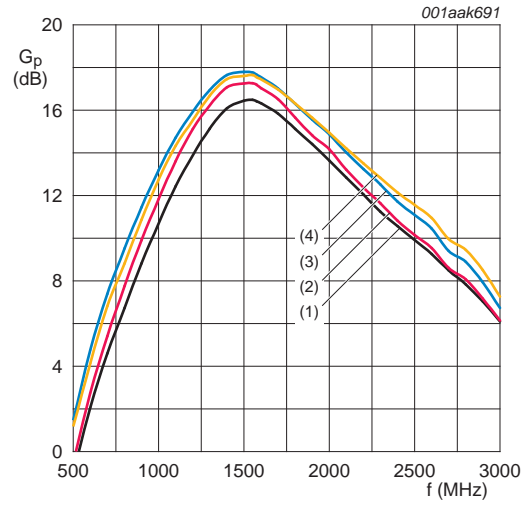

$V_{CC} = 1.8\text{ V}; T_{amb} = 25\text{ }^\circ\text{C}$.
 (1) $P_i = -45\text{ dBm}$
 (2) $P_i = -30\text{ dBm}$
 (3) $P_i = -20\text{ dBm}$
 (4) $P_i = -15\text{ dBm}$

Fig 5. Power gain as a function of frequency; typical values

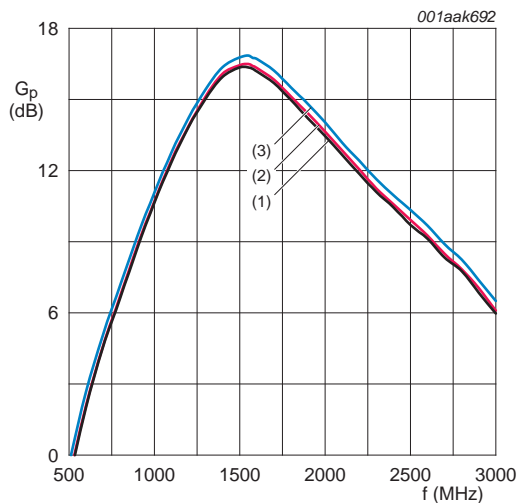

$P_i = -45\text{ dBm}; T_{amb} = 25\text{ }^\circ\text{C}$.
 (1) $V_{CC} = 1.5\text{ V}$
 (2) $V_{CC} = 1.8\text{ V}$
 (3) $V_{CC} = 2.85\text{ V}$

Fig 6. Power gain as a function of frequency; typical values

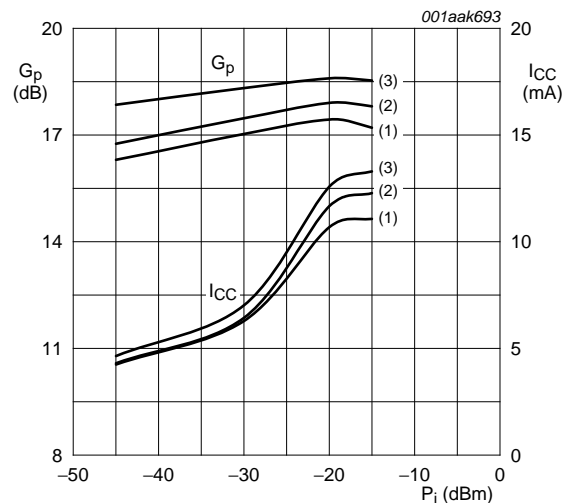

$T_{amb} = 25\text{ }^\circ\text{C}; f = 1575\text{ MHz}$.
 (1) $V_{CC} = 1.5\text{ V}$
 (2) $V_{CC} = 1.8\text{ V}$
 (3) $V_{CC} = 2.85\text{ V}$

Fig 7. Power gain as a function of input power; typical values

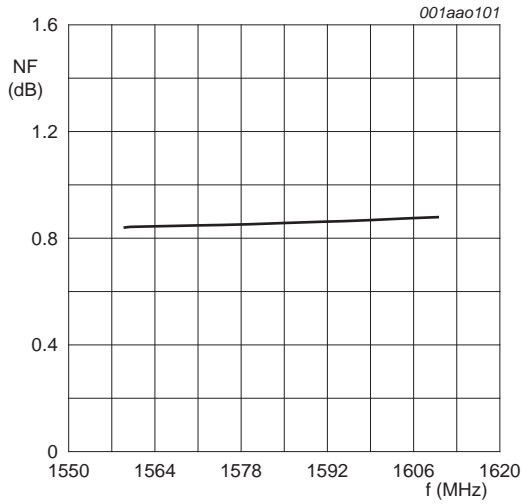

$f = 1575 \text{ MHz}$; $T_{\text{amb}} = 25 \text{ }^\circ\text{C}$; no jammer.

Fig 8. Noise figure as a function of frequency; typical values

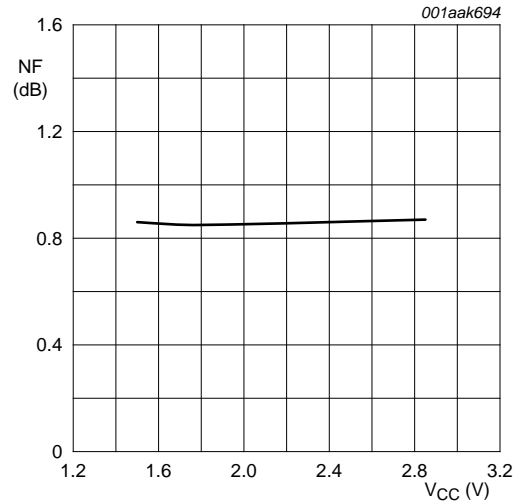

$f = 1575 \text{ MHz}$; $T_{\text{amb}} = 25 \text{ }^\circ\text{C}$; no jammer.

Fig 9. Noise figure as a function of supply voltage; typical values

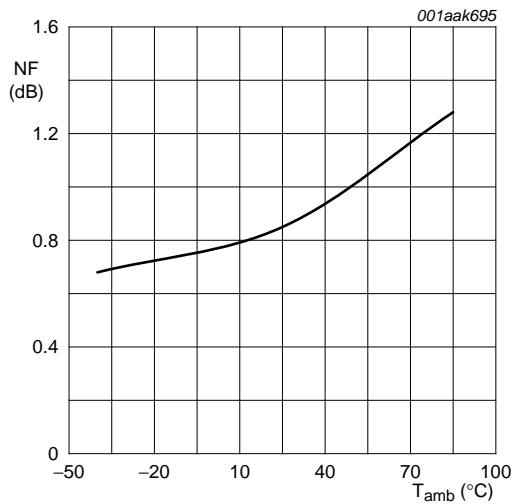

$f = 1575 \text{ MHz}$; $V_{\text{CC}} = 1.8 \text{ V}$; no jammer.

Fig 10. Noise figure as a function of ambient temperature; typical values

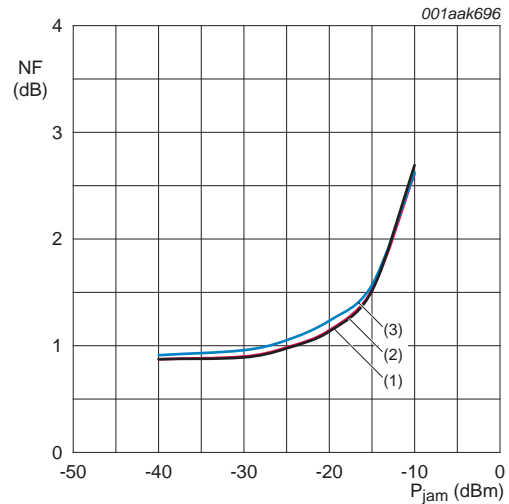

$f_{\text{jam}} = 850 \text{ MHz}$; $T_{\text{amb}} = 25 \text{ }^\circ\text{C}$; $f = 1575 \text{ MHz}$.

- (1) $V_{\text{CC}} = 1.5 \text{ V}$
- (2) $V_{\text{CC}} = 1.8 \text{ V}$
- (3) $V_{\text{CC}} = 2.85 \text{ V}$

Fig 11. Noise figure as a function of jamming power; typical values

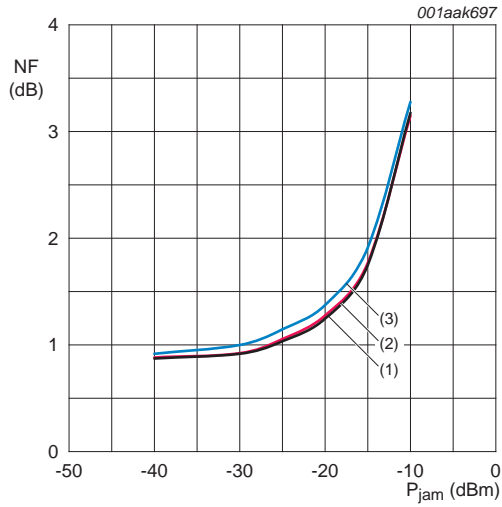

001aak697

$f_{jam} = 1850 \text{ MHz}; T_{amb} = 25 \text{ }^\circ\text{C}; f = 1575 \text{ MHz}.$

- (1) $V_{CC} = 1.5 \text{ V}$
- (2) $V_{CC} = 1.8 \text{ V}$
- (3) $V_{CC} = 2.85 \text{ V}$

Fig 12. Noise figure as a function of jamming power; typical values

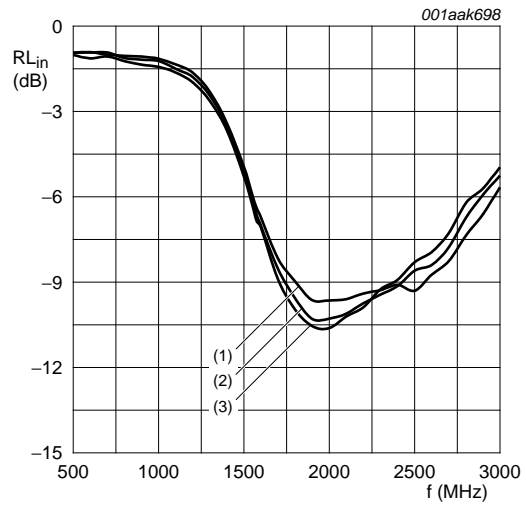

001aak698

$V_{CC} = 1.8 \text{ V}; P_i = -45 \text{ dBm}.$

- (1) $T_{amb} = -40 \text{ }^\circ\text{C}$
- (2) $T_{amb} = +25 \text{ }^\circ\text{C}$
- (3) $T_{amb} = +85 \text{ }^\circ\text{C}$

Fig 13. Input return loss as a function of frequency; typical values

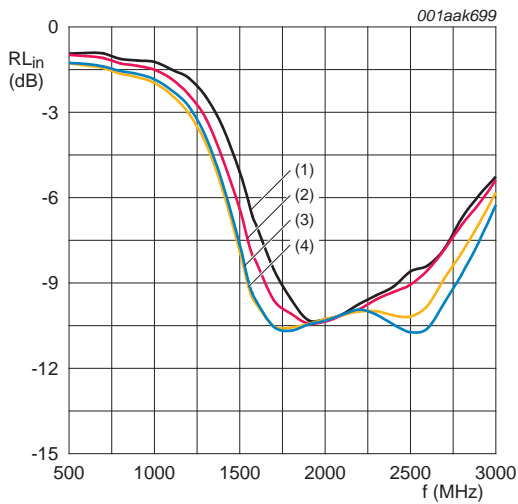

001aak699

$V_{CC} = 1.8 \text{ V}; T_{amb} = 25 \text{ }^\circ\text{C}.$

- (1) $P_i = -45 \text{ dBm}$
- (2) $P_i = -30 \text{ dBm}$
- (3) $P_i = -20 \text{ dBm}$
- (4) $P_i = -15 \text{ dBm}$

Fig 14. Input return loss as a function of frequency; typical values

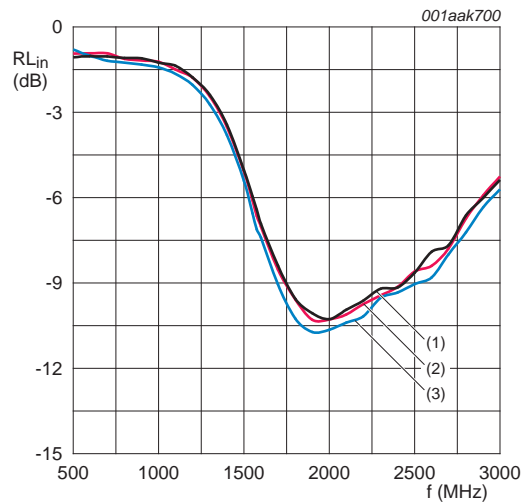

001aak700

$P_i = -45 \text{ dBm}; T_{amb} = 25 \text{ }^\circ\text{C}.$

- (1) $V_{CC} = 1.5 \text{ V}$
- (2) $V_{CC} = 1.8 \text{ V}$
- (3) $V_{CC} = 2.85 \text{ V}$

Fig 15. Input return loss as a function of frequency; typical values

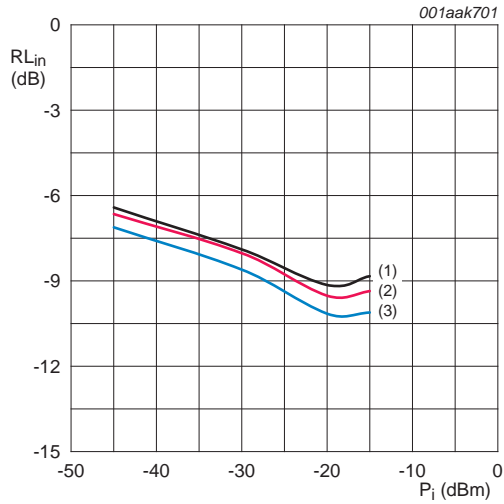

$T_{amb} = 25\text{ }^{\circ}\text{C}$; $f = 1575\text{ MHz}$.
 (1) $V_{CC} = 1.5\text{ V}$
 (2) $V_{CC} = 1.8\text{ V}$
 (3) $V_{CC} = 2.85\text{ V}$

Fig 16. Input return loss as a function of input power; typical values

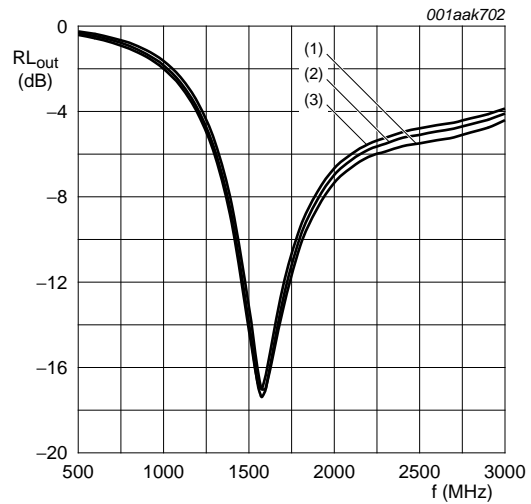

$V_{CC} = 1.8\text{ V}$; $P_i = -45\text{ dBm}$.
 (1) $T_{amb} = -40\text{ }^{\circ}\text{C}$
 (2) $T_{amb} = +25\text{ }^{\circ}\text{C}$
 (3) $T_{amb} = +85\text{ }^{\circ}\text{C}$

Fig 17. Output return loss as a function of frequency; typical values

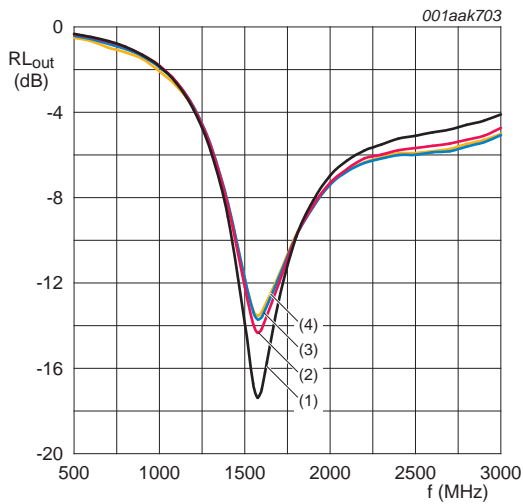

$V_{CC} = 1.8\text{ V}$; $T_{amb} = 25\text{ }^{\circ}\text{C}$.
 (1) $P_i = -45\text{ dBm}$
 (2) $P_i = -30\text{ dBm}$
 (3) $P_i = -20\text{ dBm}$
 (4) $P_i = -15\text{ dBm}$

Fig 18. Output return loss as a function of frequency; typical values

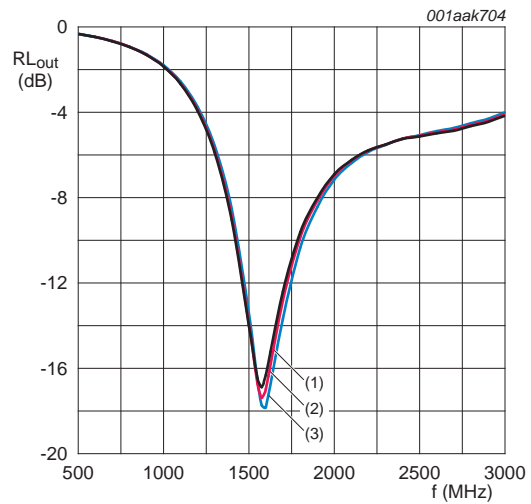

$P_i = -45\text{ dBm}$; $T_{amb} = 25\text{ }^{\circ}\text{C}$.
 (1) $V_{CC} = 1.5\text{ V}$
 (2) $V_{CC} = 1.8\text{ V}$
 (3) $V_{CC} = 2.85\text{ V}$

Fig 19. Output return loss as a function of frequency; typical values

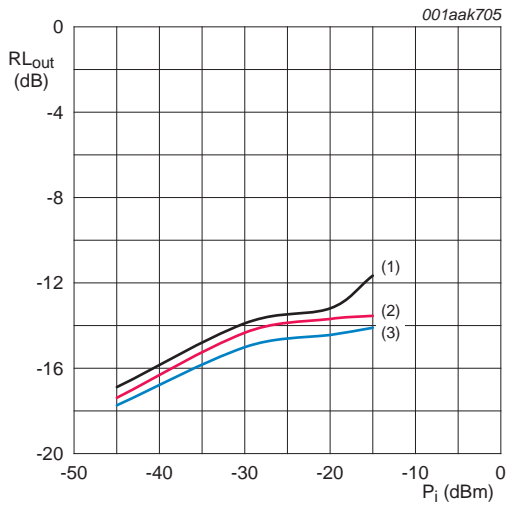

$T_{amb} = 25\text{ }^{\circ}\text{C}$; $f = 1575\text{ MHz}$.
 (1) $V_{CC} = 1.5\text{ V}$
 (2) $V_{CC} = 1.8\text{ V}$
 (3) $V_{CC} = 2.85\text{ V}$

Fig 20. Output return loss as a function of input power; typical values

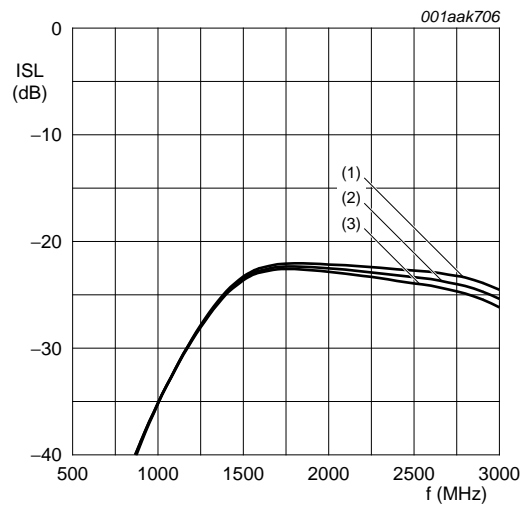

$V_{CC} = 1.8\text{ V}$; $P_i = -45\text{ dBm}$.
 (1) $T_{amb} = -40\text{ }^{\circ}\text{C}$
 (2) $T_{amb} = +25\text{ }^{\circ}\text{C}$
 (3) $T_{amb} = +85\text{ }^{\circ}\text{C}$

Fig 21. Isolation as a function of frequency; typical values

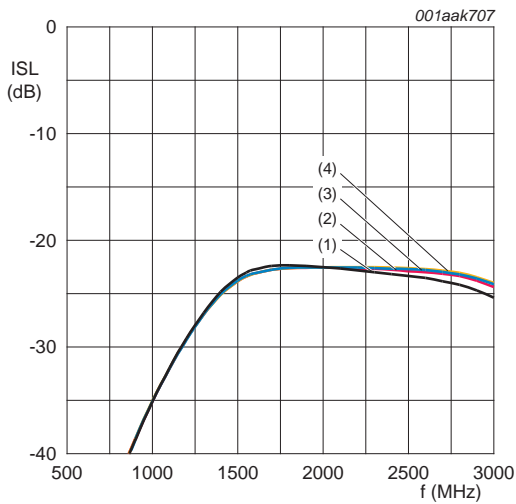

$V_{CC} = 1.8\text{ V}$; $T_{amb} = 25\text{ }^{\circ}\text{C}$.
 (1) $P_i = -45\text{ dBm}$
 (2) $P_i = -30\text{ dBm}$
 (3) $P_i = -20\text{ dBm}$
 (4) $P_i = -15\text{ dBm}$

Fig 22. Isolation as a function of frequency; typical values

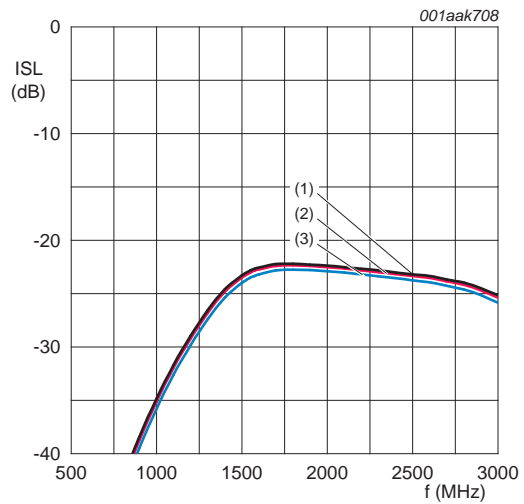

$P_i = -45\text{ dBm}$; $T_{amb} = 25\text{ }^{\circ}\text{C}$.
 (1) $V_{CC} = 1.5\text{ V}$
 (2) $V_{CC} = 1.8\text{ V}$
 (3) $V_{CC} = 2.85\text{ V}$

Fig 23. Isolation as a function of frequency; typical values

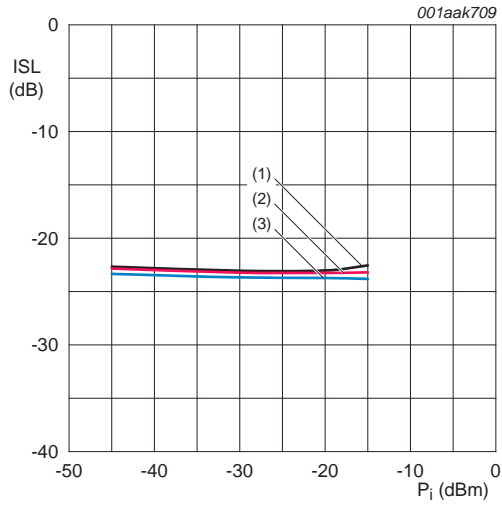

$T_{amb} = 25\text{ }^{\circ}\text{C}$; $f = 1575\text{ MHz}$.
 (1) $V_{CC} = 1.5\text{ V}$
 (2) $V_{CC} = 1.8\text{ V}$
 (3) $V_{CC} = 2.85\text{ V}$

Fig 24. Isolation as a function of input power; typical values

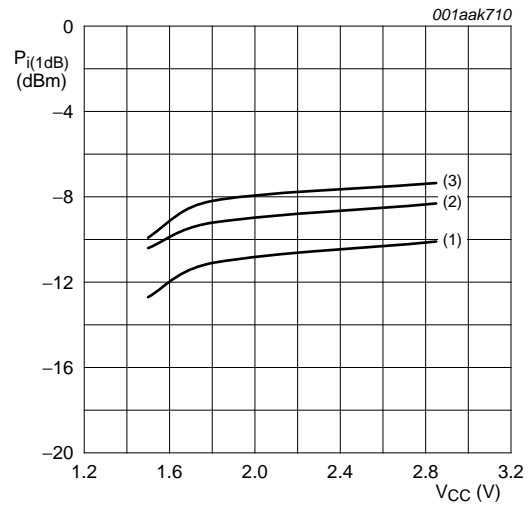

$f = 850\text{ MHz}$.
 (1) $T_{amb} = -40\text{ }^{\circ}\text{C}$
 (2) $T_{amb} = +25\text{ }^{\circ}\text{C}$
 (3) $T_{amb} = +85\text{ }^{\circ}\text{C}$

Fig 25. Input power at 1 dB gain compression as a function of supply voltage; typical values

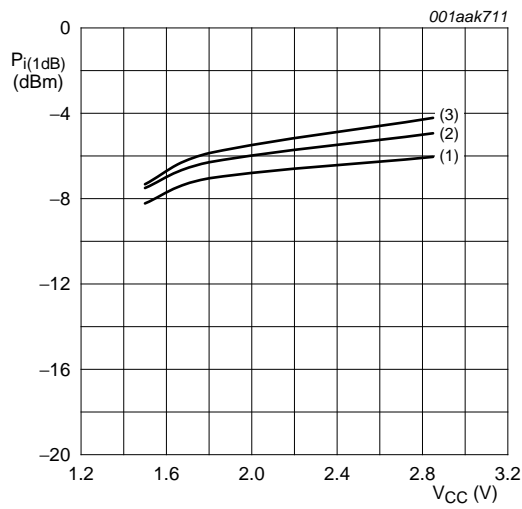

$f = 1850\text{ MHz}$.
 (1) $T_{amb} = -40\text{ }^{\circ}\text{C}$
 (2) $T_{amb} = +25\text{ }^{\circ}\text{C}$
 (3) $T_{amb} = +85\text{ }^{\circ}\text{C}$

Fig 26. Input power at 1 dB gain compression as a function of supply voltage; typical values

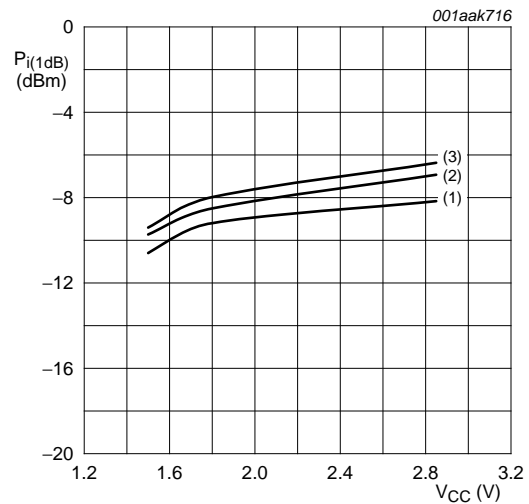

$f = 1575\text{ MHz}$.
 (1) $T_{amb} = -40\text{ }^{\circ}\text{C}$
 (2) $T_{amb} = +25\text{ }^{\circ}\text{C}$
 (3) $T_{amb} = +85\text{ }^{\circ}\text{C}$

Fig 27. Input power at 1 dB gain compression as a function of supply voltage; typical values

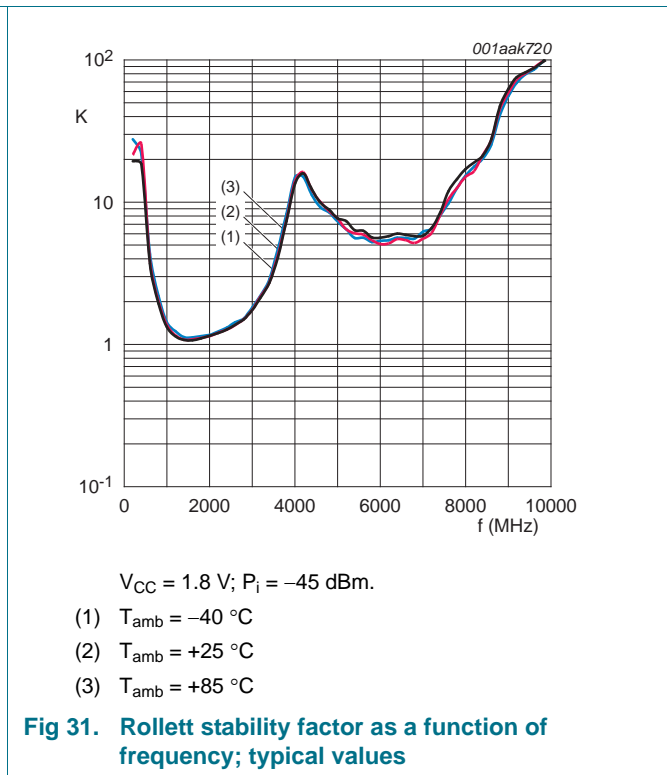
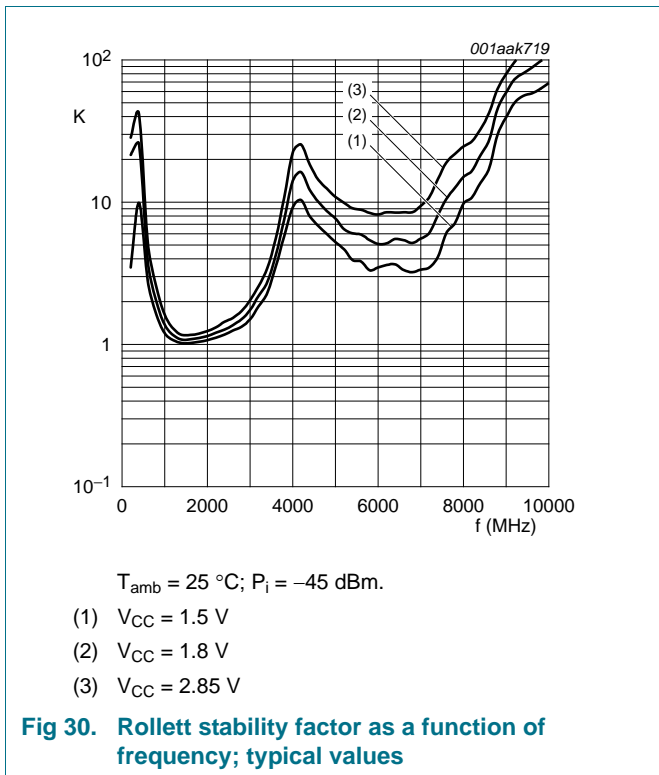
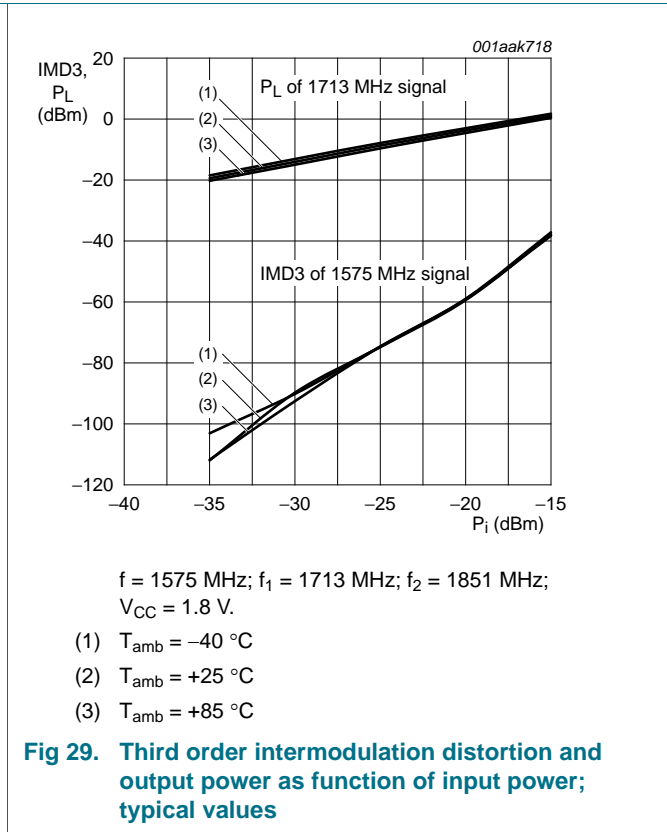
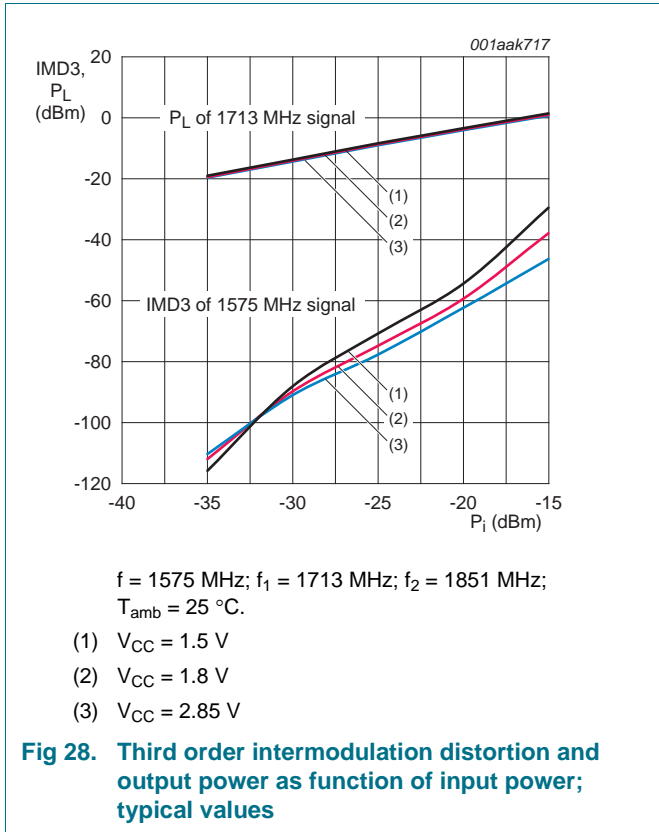

8.2 GPS front-end

The GPS LNA is typically used in a GPS front-end. A GPS front-end application circuit and its characteristics is provided here.

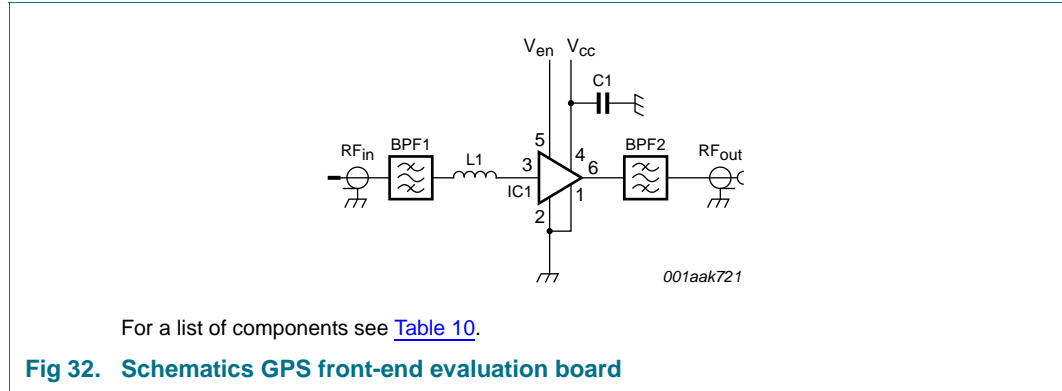

Table 10. List of components

For schematics see [Figure 32](#).

Component	Description	Value	Supplier	Remarks
BPF1, BPF2	GPS SAW filter	-	Murata SAFEA1G57KE0F00	Alternatives from Epcos: <ul style="list-style-type: none"> • B9444 Alternatives from Murata: <ul style="list-style-type: none"> • SAFEA1G57KH0F00 • SAFEA1G57KB0F00 Alternatives from Fujitsu: <ul style="list-style-type: none"> • FAR-F6KA-1G5754-L4AA • FAR-F6KA-1G5754-L4AJ
C1	decoupling capacitor	1 nF	Various	
IC1	BGU7005	-	NXP	
L1	high quality matching inductor	5.6 nH	Murata LQW15A	

8.3 Characteristics GPS front-end

Table 11. Characteristics GPS front-end

$f = 1575 \text{ MHz}$; $V_{CC} = 1.8 \text{ V}$; $V_{ENABLE} \geq 0.8 \text{ V}$; power at LNA input $P_i < -40 \text{ dBm}$; $T_{amb} = 25 \text{ }^\circ\text{C}$; input and output matched to $50 \text{ } \Omega$; unless otherwise specified.

Symbol	Parameter	Conditions	Min	Typ	Max	Unit
V_{CC}	supply voltage	RF input AC coupled	1.5	-	2.85	V
I_{CC}	supply current		-	4.5	-	mA
T_{amb}	ambient temperature		-40	+25	+85	$^\circ\text{C}$
G_p	power gain	power at LNA input $P_i < -40 \text{ dBm}$	[1]	-	14.5	dB
		power at LNA input $P_i = -20 \text{ dBm}$	[1]	-	15.5	dB
RL_{in}	input return loss	power at LNA input $P_i < -40 \text{ dBm}$	[1]	-	8.5	dB
		power at LNA input $P_i = -20 \text{ dBm}$	[1]	-	10.5	dB
RL_{out}	output return loss	power at LNA input $P_i < -40 \text{ dBm}$	[1]	-	14.5	dB
		power at LNA input $P_i = -20 \text{ dBm}$	[1]	-	12.5	dB

Table 11. Characteristics GPS front-end ...continued

$f = 1575 \text{ MHz}$; $V_{CC} = 1.8 \text{ V}$; $V_{ENABLE} \geq 0.8 \text{ V}$; power at LNA input $P_i < -40 \text{ dBm}$; $T_{amb} = 25 \text{ }^\circ\text{C}$; input and output matched to $50 \text{ } \Omega$; unless otherwise specified.

Symbol	Parameter	Conditions	Min	Typ	Max	Unit	
NF	noise figure	power at LNA input $P_i < -40 \text{ dBm}$	[1]	-	1.8	-	dB
		power at LNA input $P_i = -20 \text{ dBm}$	[1]	-	1.9	-	dB
$P_{i(1dB)}$	input power at 1 dB gain compression	$f = 1575 \text{ MHz}$			-8.2		dBm
		$f = 806 \text{ MHz to } 928 \text{ MHz}$	[2]		31		dBm
		$f = 1612 \text{ MHz to } 1909 \text{ MHz}$	[2]		40		dBm
$IP3_i$	input third-order intercept point		[3]		64		dBm
α	attenuation	$f = 850 \text{ MHz}$	[4]	95	-	-	dBc
		$f = 1850 \text{ MHz}$	[4]	90	-	-	dBc
t_{on}	turn-on time		[5]	-	-	2	μs
t_{off}	turn-off time		[5]	-	-	1	μs

[1] Power at GPS front-end input = power at LNA input + attenuation BPF1.

[2] Out of band.

[3] $f_1 = 1713 \text{ MHz}$; $f_2 = 1851 \text{ MHz}$; $P_1 = P_2 = +10 \text{ dBm}$.

[4] Relative to $f = 1575 \text{ MHz}$.

[5] Within 10 % of the final gain.

9. Package outline

XSON6: plastic extremely thin small outline package; no leads; 6 terminals; body 1 x 1.45 x 0.5 mm

SOT886

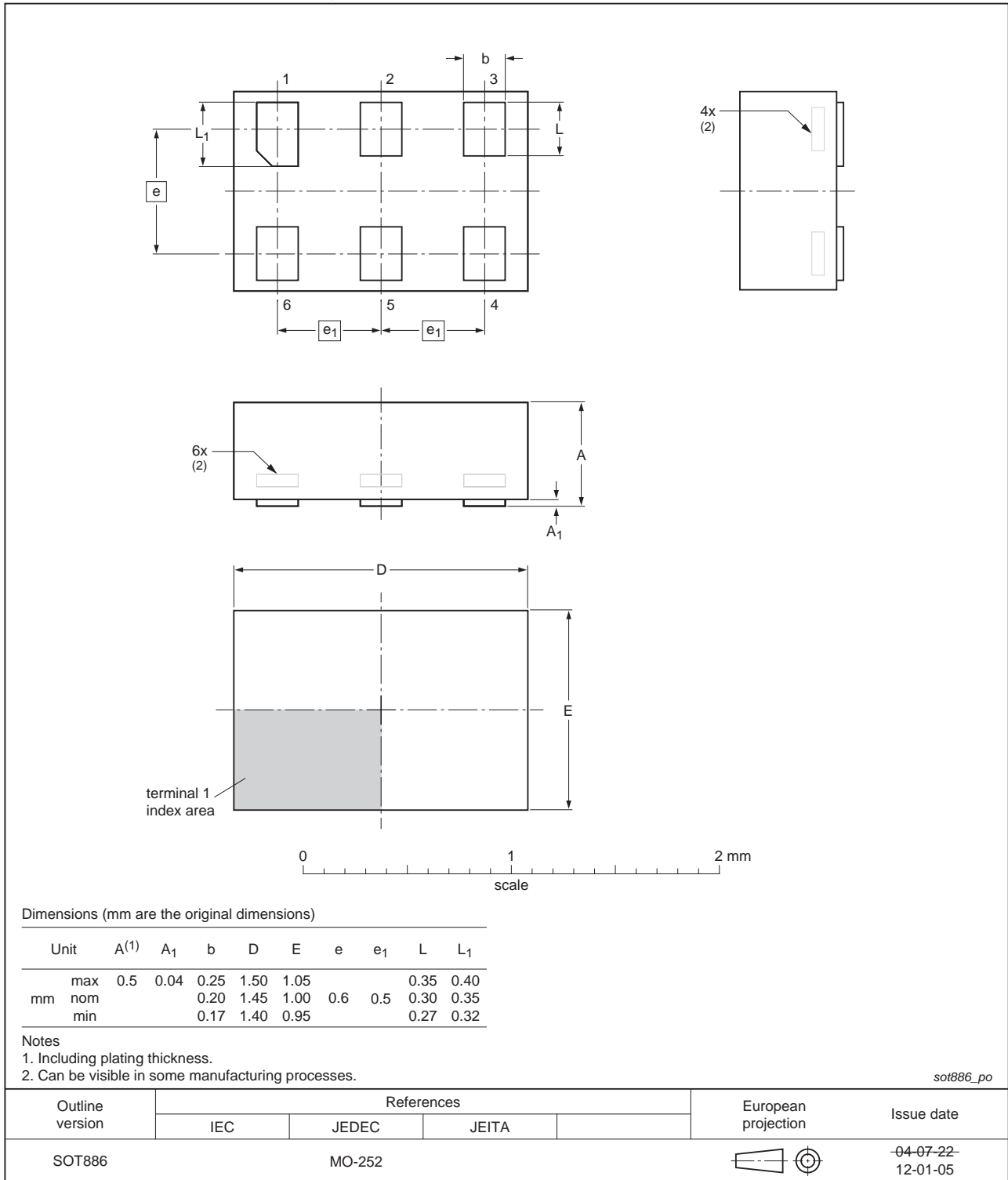

Fig 33. Package outline SOT886 (XSON6)

10. Abbreviations

Table 12. Abbreviations

Acronym	Description
AC	Alternating Current
ATM	Automated Teller Machine (cash dispenser)
DC	Direct Current
GLONASS	GLObal NAVigation Satellite System
GNSS	Global Navigation Satellite System
GPS	Global Positioning System
HBM	Human Body Model
MMIC	Monolithic Microwave Integrated Circuit
PC	Personal Computer
PCB	Printed Circuit Board
RF	Radio Frequency
SAW	Surface Acoustic Wave
SiGe:C	Silicon Germanium Carbon

11. Revision history

Table 13. Revision history

Document ID	Release date	Data sheet status	Change notice	Supersedes
BGU7005 v.6	20170118	Product data sheet	-	BGU7005 v.5
Modifications:	<ul style="list-style-type: none"> • Section 1: added GPS1101M according to our new naming convention 			
BGU7005 v.5	<tbd>	Product data sheet	-	BGU7005 v.4
Modifications:	<ul style="list-style-type: none"> • Added 'Compass' to descriptive title • Section 1.2 on page 1: row 6, changed 2.8.5 V to 3.1 V • Section 1.3 on page 2: updated • Table 1 on page 2, Table 7 on page 4 and Table 8 on page 5: changed value V_{CC} from 2.85 V to 3.1 V • Table 5 on page 3: several additions and changes • Figure 8 on page 8 and Figure 9 on page 8: corrected figure titles 			
BGU7005 v.4	20110506	Product data sheet	-	BGU7005 v.3
BGU7005 v.3	20100623	Product data sheet	-	BGU7005_2
BGU7005_2	20100304	Product data sheet	-	BGU7005_1
BGU7005_1	20091028	Preliminary data sheet	-	-

12. Legal information

12.1 Data sheet status

Document status ^{[1][2]}	Product status ^[3]	Definition
Objective [short] data sheet	Development	This document contains data from the objective specification for product development.
Preliminary [short] data sheet	Qualification	This document contains data from the preliminary specification.
Product [short] data sheet	Production	This document contains the product specification.

[1] Please consult the most recently issued document before initiating or completing a design.

[2] The term 'short data sheet' is explained in section "Definitions".

[3] The product status of device(s) described in this document may have changed since this document was published and may differ in case of multiple devices. The latest product status information is available on the Internet at URL <http://www.nxp.com>.

12.2 Definitions

Draft — The document is a draft version only. The content is still under internal review and subject to formal approval, which may result in modifications or additions. NXP Semiconductors does not give any representations or warranties as to the accuracy or completeness of information included herein and shall have no liability for the consequences of use of such information.

Short data sheet — A short data sheet is an extract from a full data sheet with the same product type number(s) and title. A short data sheet is intended for quick reference only and should not be relied upon to contain detailed and full information. For detailed and full information see the relevant full data sheet, which is available on request via the local NXP Semiconductors sales office. In case of any inconsistency or conflict with the short data sheet, the full data sheet shall prevail.

Product specification — The information and data provided in a Product data sheet shall define the specification of the product as agreed between NXP Semiconductors and its customer, unless NXP Semiconductors and customer have explicitly agreed otherwise in writing. In no event however, shall an agreement be valid in which the NXP Semiconductors product is deemed to offer functions and qualities beyond those described in the Product data sheet.

12.3 Disclaimers

Limited warranty and liability — Information in this document is believed to be accurate and reliable. However, NXP Semiconductors does not give any representations or warranties, expressed or implied, as to the accuracy or completeness of such information and shall have no liability for the consequences of use of such information. NXP Semiconductors takes no responsibility for the content in this document if provided by an information source outside of NXP Semiconductors.

In no event shall NXP Semiconductors be liable for any indirect, incidental, punitive, special or consequential damages (including - without limitation - lost profits, lost savings, business interruption, costs related to the removal or replacement of any products or rework charges) whether or not such damages are based on tort (including negligence), warranty, breach of contract or any other legal theory.

Notwithstanding any damages that customer might incur for any reason whatsoever, NXP Semiconductors' aggregate and cumulative liability towards customer for the products described herein shall be limited in accordance with the *Terms and conditions of commercial sale* of NXP Semiconductors.

Right to make changes — NXP Semiconductors reserves the right to make changes to information published in this document, including without limitation specifications and product descriptions, at any time and without notice. This document supersedes and replaces all information supplied prior to the publication hereof.

Suitability for use — NXP Semiconductors products are not designed, authorized or warranted to be suitable for use in life support, life-critical or safety-critical systems or equipment, nor in applications where failure or malfunction of an NXP Semiconductors product can reasonably be expected to result in personal injury, death or severe property or environmental damage. NXP Semiconductors and its suppliers accept no liability for inclusion and/or use of NXP Semiconductors products in such equipment or applications and therefore such inclusion and/or use is at the customer's own risk.

Applications — Applications that are described herein for any of these products are for illustrative purposes only. NXP Semiconductors makes no representation or warranty that such applications will be suitable for the specified use without further testing or modification.

Customers are responsible for the design and operation of their applications and products using NXP Semiconductors products, and NXP Semiconductors accepts no liability for any assistance with applications or customer product design. It is customer's sole responsibility to determine whether the NXP Semiconductors product is suitable and fit for the customer's applications and products planned, as well as for the planned application and use of customer's third party customer(s). Customers should provide appropriate design and operating safeguards to minimize the risks associated with their applications and products.

NXP Semiconductors does not accept any liability related to any default, damage, costs or problem which is based on any weakness or default in the customer's applications or products, or the application or use by customer's third party customer(s). Customer is responsible for doing all necessary testing for the customer's applications and products using NXP Semiconductors products in order to avoid a default of the applications and the products or of the application or use by customer's third party customer(s). NXP does not accept any liability in this respect.

Limiting values — Stress above one or more limiting values (as defined in the Absolute Maximum Ratings System of IEC 60134) will cause permanent damage to the device. Limiting values are stress ratings only and (proper) operation of the device at these or any other conditions above those given in the Recommended operating conditions section (if present) or the Characteristics sections of this document is not warranted. Constant or repeated exposure to limiting values will permanently and irreversibly affect the quality and reliability of the device.

Terms and conditions of commercial sale — NXP Semiconductors products are sold subject to the general terms and conditions of commercial sale, as published at <http://www.nxp.com/profile/terms>, unless otherwise agreed in a valid written individual agreement. In case an individual agreement is concluded only the terms and conditions of the respective agreement shall apply. NXP Semiconductors hereby expressly objects to applying the customer's general terms and conditions with regard to the purchase of NXP Semiconductors products by customer.

No offer to sell or license — Nothing in this document may be interpreted or construed as an offer to sell products that is open for acceptance or the grant, conveyance or implication of any license under any copyrights, patents or other industrial or intellectual property rights.

Export control — This document as well as the item(s) described herein may be subject to export control regulations. Export might require a prior authorization from competent authorities.

Non-automotive qualified products — Unless this data sheet expressly states that this specific NXP Semiconductors product is automotive qualified, the product is not suitable for automotive use. It is neither qualified nor tested in accordance with automotive testing or application requirements. NXP Semiconductors accepts no liability for inclusion and/or use of non-automotive qualified products in automotive equipment or applications.

In the event that customer uses the product for design-in and use in automotive applications to automotive specifications and standards, customer (a) shall use the product without NXP Semiconductors' warranty of the product for such automotive applications, use and specifications, and (b) whenever customer uses the product for automotive applications beyond NXP Semiconductors' specifications such use shall be solely at customer's own risk, and (c) customer fully indemnifies NXP Semiconductors for any

liability, damages or failed product claims resulting from customer design and use of the product for automotive applications beyond NXP Semiconductors' standard warranty and NXP Semiconductors' product specifications.

Quick reference data — The Quick reference data is an extract of the product data given in the Limiting values and Characteristics sections of this document, and as such is not complete, exhaustive or legally binding.

Translations — A non-English (translated) version of a document is for reference only. The English version shall prevail in case of any discrepancy between the translated and English versions.

12.4 Trademarks

Notice: All referenced brands, product names, service names and trademarks are the property of their respective owners.

13. Contact information

For more information, please visit: <http://www.nxp.com>

For sales office addresses, please send an email to: salesaddresses@nxp.com

14. Contents

1	Product profile	1
1.1	General description	1
1.2	Features and benefits	1
1.3	Applications	2
1.4	Quick reference data	2
2	Pinning information	2
3	Ordering information	3
4	Marking	3
5	Limiting values	3
6	Thermal characteristics	3
7	Characteristics	4
8	Application information	6
8.1	GNSS LNA	6
8.2	GPS front-end	14
8.3	Characteristics GPS front-end	14
9	Package outline	16
10	Abbreviations	17
11	Revision history	17
12	Legal information	18
12.1	Data sheet status	18
12.2	Definitions	18
12.3	Disclaimers	18
12.4	Trademarks	19
13	Contact information	19
14	Contents	20

Please be aware that important notices concerning this document and the product(s) described herein, have been included in section 'Legal information'.

© NXP B.V. 2017.

All rights reserved.

For more information, please visit: <http://www.nxp.com>

For sales office addresses, please send an email to: salesaddresses@nxp.com

Date of release: 18 January 2017

Document identifier: BGU7005