



Discription

The HCPDUC5V0USP-HF protects sensitive semiconductor components from damage or upset due to electrostatic discharge (ESD) and other voltage induced transient events.

Excellent clamping capability, low leakage, low capacitance, and fast response time provide best in class protection on designs that are exposed to ESD.

It gives designer the flexibility to protect one unidirectional line in applications where arrays are not practical.



SOD-523

Features

- ★ Transient protection for high-speed data lines
IEC 61000-4-2(ESD) ±8kV (Contact)
±15kV (Air)
IEC 61000-4-4(EFT) 40A (5/50 ns)
- ★ Peak power dissipation: 60W (8/20us)
- ★ Working voltages : 5V
- ★ Protects one Vcc or data line
- ★ Low clamping voltage
- ★ Low leakage current



Circuit Diagram

Ordering information

Product ID	Pack	Qty(PCS)
HCPDUC5V0USP-HF	SOD-523	3000

Absolute Ratings(Tamb = 25°C)

Symbol	Parameter	Value	Units
P _{PP}	Peak Pulse Power (t _p = 8/20 μ s)	60	W
T _L	Maximum lead temperature for soldering during 10s	260	°C
T _{stg}	Storage Temperature Range	-55 to +155	°C
T _{op}	Operating Temperature Range	-40 to +125	°C
T _j	Maximum junction temperature	150	°C
	IEC61000-4-2 (ESD) air discharge	± 15	KV
	contact discharge	± 8	
	IEC61000-4-4 (EFT)	40	A



Electrical Characteristics

Symbol	Parameter	Test Condition	Min	Typ	Max	Units
V_{RWM}	Reverse Working Voltage				5.0	V
V_{BR}	Reverse Breakdown Voltage	$I_T = 1mA$	6.0			V
I_R	Reverse Leakage Current	$V_{RWM} = 5.0V$			100	nA
V_C	Clamping Voltage	$I_{RWM} = 1A, t_p = 8/20\mu s$			10	V
		$I_{RWM} = 4A, t_p = 8/20\mu s$			15	V
C_J	Junction Capacitance	$V_R = 0V, f = 1MHz$		0.4	0.7	pF



Typical Characteristics

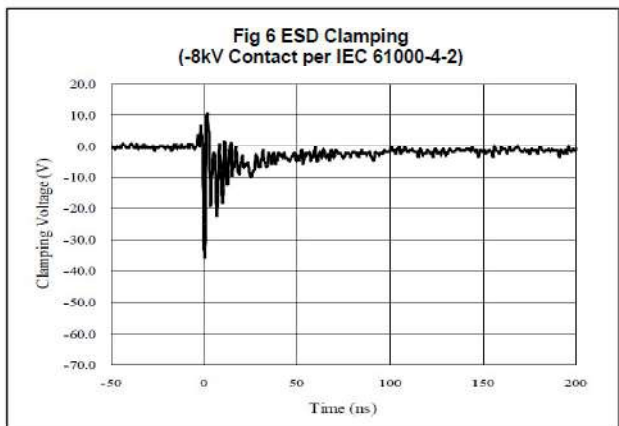
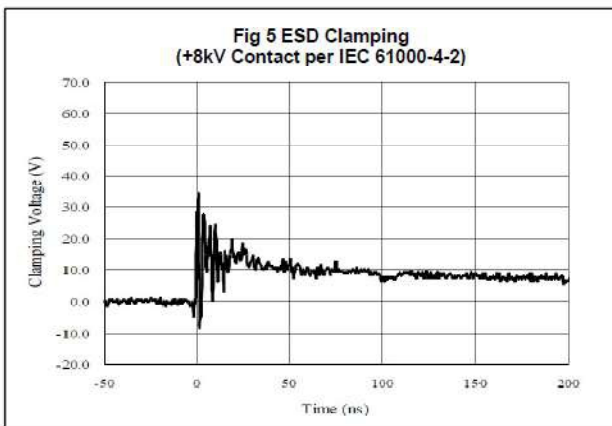
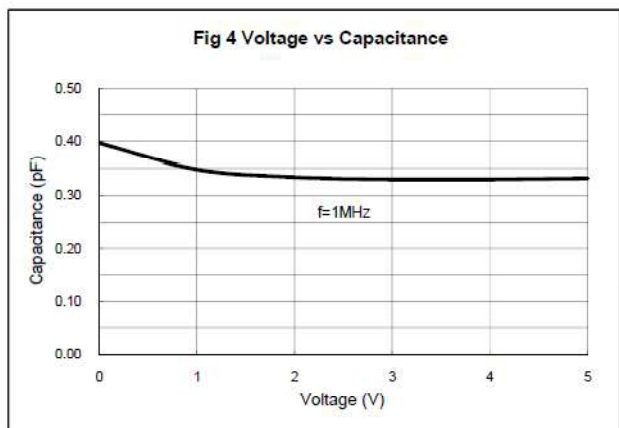
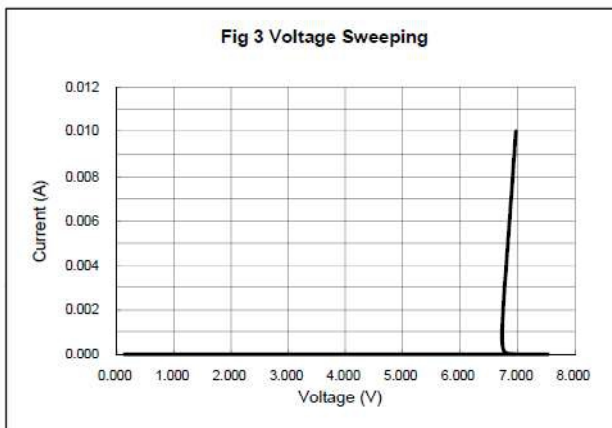
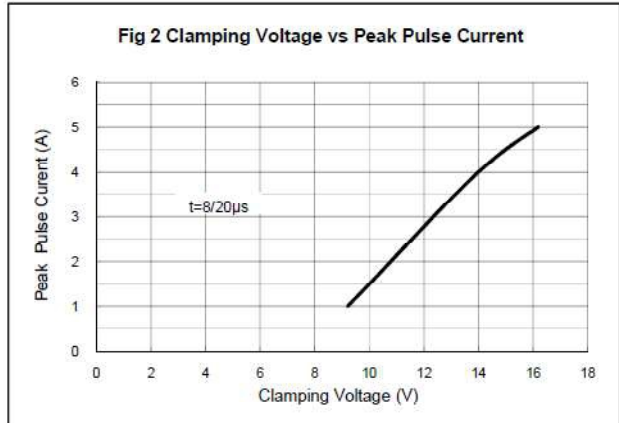
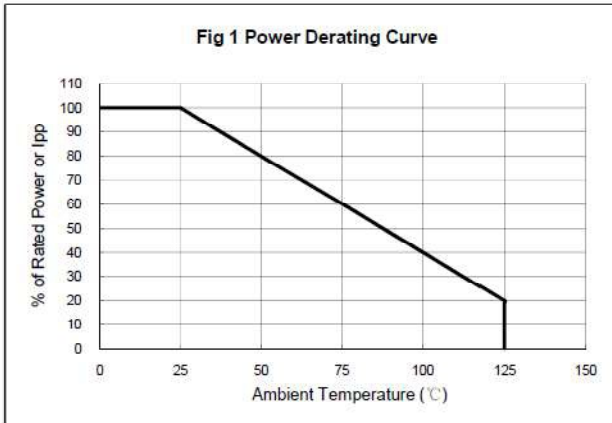



Outline And Dimensions

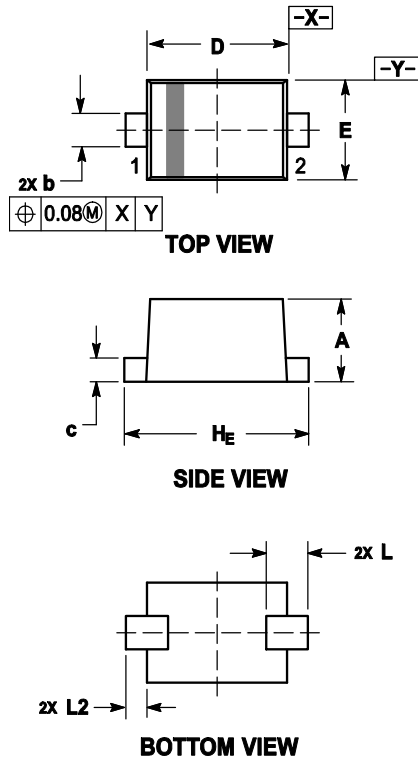

Notes:

1. DIMENSIONING AND TOLERANCING PER ANSI Y14.5M, 1982.
2. CONTROLLING DIMENSION: MILLIMETERS.
3. MAXIMUM LEAD THICKNESS INCLUDES LEAD FINISH. MINIMUM LEAD THICKNESS IS THE MINIMUM THICKNESS OF BASE MATERIAL.
4. DIMENSIONS D AND E DO NOT INCLUDE MOLD FLASH, PROTRUSIONS OR GATE BURRS.

DIM	MILLIMETERS			INCHES		
	MIN	NOM	MAX	MIN	NOM	MAX
A	0.50	0.60	0.70	0.020	0.024	0.028
b	0.25	0.30	0.35	0.010	0.012	0.014
c	0.07	0.14	0.20	0.003	0.006	0.008
D	1.10	1.20	1.30	0.043	0.047	0.051
E	0.70	0.80	0.90	0.028	0.031	0.035
H _E	1.50	1.60	1.70	0.059	0.063	0.067
L	0.30 REF			0.012 REF		
L ₂	0.15	0.20	0.25	0.006	0.008	0.010

Soldering Footprint

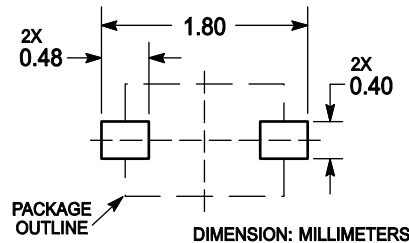



Attention

- Any and all HUA XUAN YANG ELECTRONICS products described or contained herein do not have specifications that can handle applications that require extremely high levels of reliability, such as life-support systems, aircraft's control systems, or other applications whose failure can be reasonably expected to result in serious physical and/or material damage. Consult with your HUA XUAN YANG ELECTRONICS representative nearest you before using any HUA XUAN YANG ELECTRONICS products described or contained herein in such applications.
- HUA XUAN YANG ELECTRONICS assumes no responsibility for equipment failures that result from using products at values that exceed, even momentarily, rated values (such as maximum ratings, operating condition ranges, or other parameters) listed in products specifications of any and all HUA XUAN YANG ELECTRONICS products described or contained herein.
- Specifications of any and all HUA XUAN YANG ELECTRONICS products described or contained herein stipulate the performance, characteristics, and functions of the described products in the independent state, and are not guarantees of the performance, characteristics, and functions of the described products as mounted in the customer's products or equipment. To verify symptoms and states that cannot be evaluated in an independent device, the customer should always evaluate and test devices mounted in the customer's products or equipment.
- HUA XUAN YANG ELECTRONICS CO.,LTD. strives to supply high-quality high-reliability products. However, any and all semiconductor products fail with some probability. It is possible that these probabilistic failures could give rise to accidents or events that could endanger human lives, that could give rise to smoke or fire, or that could cause damage to other property. When designing equipment, adopt safety measures so that these kinds of accidents or events cannot occur. Such measures include but are not limited to protective circuits and error prevention circuits for safe design, redundant design, and structural design.
- In the event that any or all HUA XUAN YANG ELECTRONICS products(including technical data, services) described or contained herein are controlled under any of applicable local export control laws and regulations, such products must not be exported without obtaining the export license from the authorities concerned in accordance with the above law.
- No part of this publication may be reproduced or transmitted in any form or by any means, electronic or mechanical, including photocopying and recording, or any information storage or retrieval system, or otherwise, without the prior written permission of HUA XUAN YANG ELECTRONICS CO.,LTD.
- Information (including circuit diagrams and circuit parameters) herein is for example only ; it is not guaranteed for volume production. HUA XUAN YANG ELECTRONICS believes information herein is accurate and reliable, but no guarantees are made or implied regarding its use or any infringements of intellectual property rights or other rights of third parties.
- Any and all information described or contained herein are subject to change without notice due to product/technology improvement, etc. When designing equipment, refer to the "Delivery Specification" for the HUA XUAN YANG ELECTRONICS product that you intend to use.