

P.C.B LAYOUT
BOTTOM VIEW



SK-22H09-GXXX

横柄

G-Switch P/N

Switch Height (mm)

- G020=2.0 G030=3.0
- G040=4.0 G050=5.0
- G055=5.5 G060=6.0
- G065=6.5 G070=7.0
- G075=7.5 G080=8.0
- G085=8.5 G090=9.0
- G095=9.5 G100=10.0

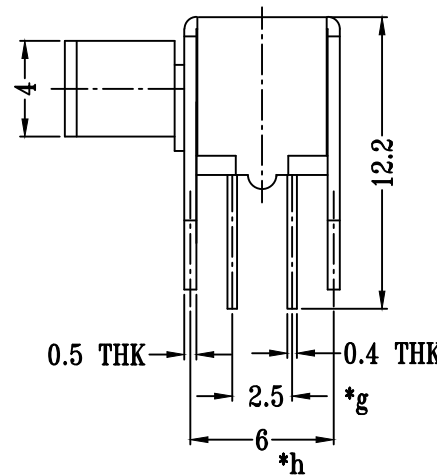
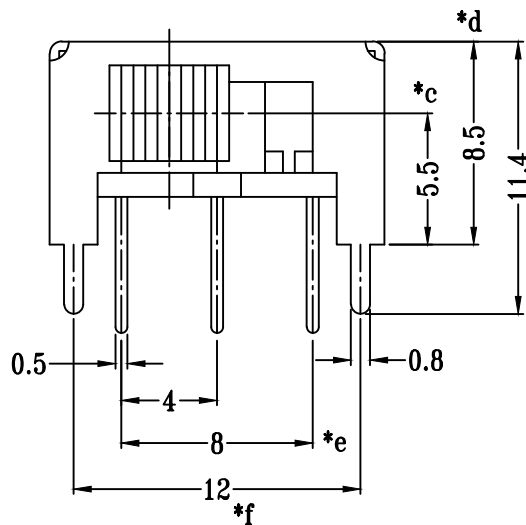

G-Switch Specification:

Electrical Specifications: 1.0A/DC24V
 Contact resistance (CR): ≤50mΩ
 Insulation Resistance(IR): ≥100MΩ DC250V
 Compressive strength (WV): AC250V 1minute
 Operating temperature: -25°C~+70°C
 Storage humidity: <85%RH
 Electrical life: 10,000Cycles.

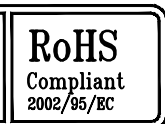
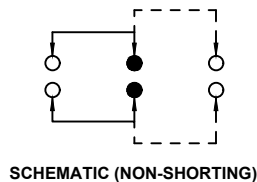

G-Switch Electronic (HongKong) CO.,Ltd.

Unless otherwise specified, Tolerance:
 X. ±0.30
 X.x ±0.20
 X.xx ±0.15
 X.xxx ±0.10
 Angles ±3°

DESIGN FengFengChen DATE 2019.05.29
 CHECKED DATE
 APPROVED DATE
<http://www.dg-switch.com>
 TEL:0769-82388879

Molde code:
SK-22H09-GXXX
 REV.: X1 SCALE: 4:1 UNIT: mm
 SIZE: A4 SHEET: 1/1