

DUAL OPERATIONAL AMPLIFIER

DESCRIPTION

MC33078 is the dual operational amplifier, specially designed for improving the tone control, which is most suitable for the audio application. Featuring noiseless, higher gain bandwidth, high output current and low distortion ratio, and it is most suitable not only for acoustic electronic part of audio pre-amp and active filter, but also for the industrial measurement tools. It is also suitable for the head phone amp at higher output current. And further more, it can be applied for the handy type set operational amplifier of general purpose in application of low voltage single supply type which is properly biased of the input low voltage source.

FEATURE

- Operating Voltage: $\pm 2V \sim \pm 16V$.
- Low Input Noise Voltage: $0.8\mu V_{rms}$ Typ.
- Wide Gain Bandwidth Product: 15mhz Typ.
- Low Distortion: 0.0005% Typ.
- Slew Rate: $5V/\mu A$ Typ.
- Package Outline DIP-8、SIP-8 and MSOP-8 .
- Bipolar Technology.

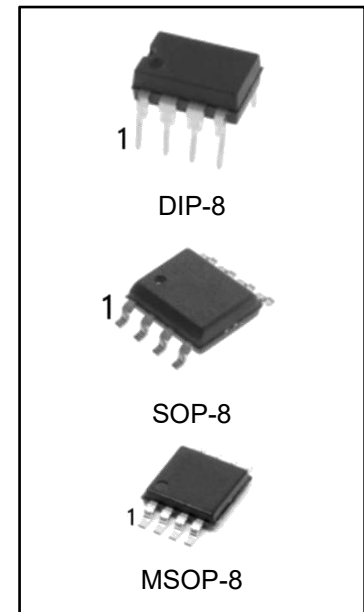

ORDERING INFORMATION

DEVICE	Package Type	MARKING	Packing	Packing Qty
MC33078N	DIP-8	MC33078	TUBE	2000pcs/box
MC33078M/TR	SOP-8	M33078	REEL	2500pcs/reel
MC33078MM/TR	MSOP-8	33078,MYU	REEL	3000pcs/reel

PIN CONFIGURATION

DIP-8/SOP-8/MSOP-8

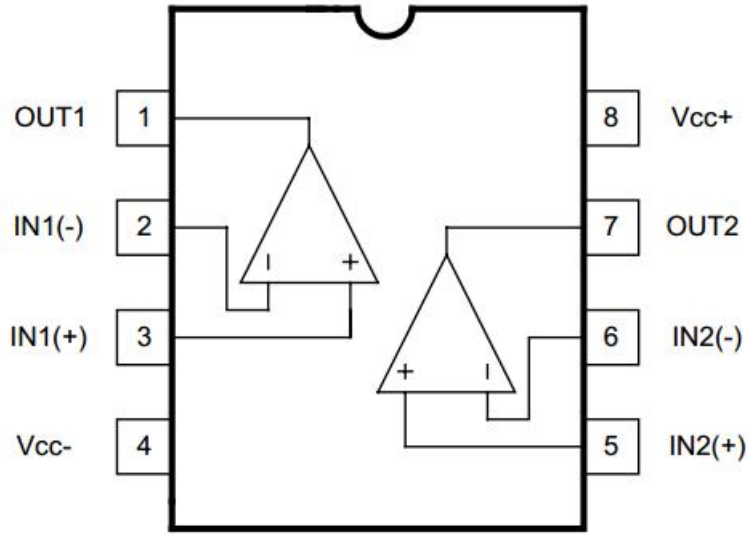

EQUIVALENT CIRCUIT

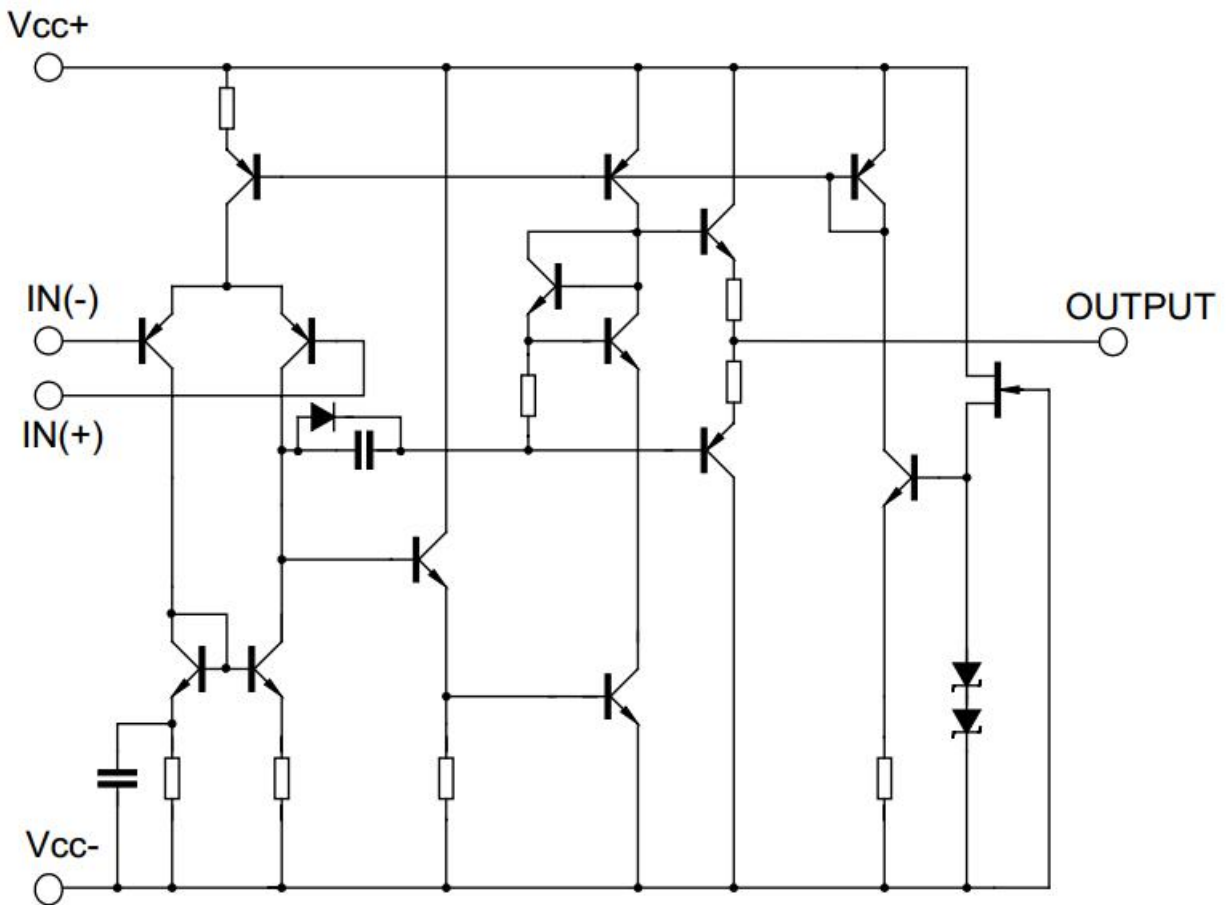

ABSOLUTE MAXIMUM RATINGS (Ta=25°C)

Characteristic		Symbol	Value	Unit
Supply Voltage		V+/V-	±16	V
Input Voltage		V _{IC}	±15	V
Differential Input Voltage		V _{ID}	±30	V
Output Current		I _O	±50	mA
Power Dissipation	DIP-8	P _D	800	mW
	SOP-8		300	
	MSOP-8		250	
Operating Temperature Range		T _{OPR}	-40~85	°C
Storage Temperature Range		T _{stg}	-40~125	°C
Lead Temperature (Soldering, 10 seconds)		T _L	245	°C

Note: Absolute Maximum Ratings indicate limits beyond which damage to the device may occur. Operating Ratings indicate conditions for which the device is intended to be functional, but specific performance is not ensured.

ELECTRICAL CHARACTERISTICS

(Unless otherwise specified: Ta= 25°C, V+/V- =±15V)

Parameter	Symbol	Test condition	Min	Typ	Max	Unit
Input Offset Voltage	V _{IO}	R _s ≤ 10 kΩ		0.5	3	mV
Input Offset Current	I _{IO}			5	200	nA
Input Bias Current	I _B			100	500	nA
Large Signal Voltage Gain	A _v	R _L ≥ 2kΩ, V _o = ±10V	90	110		dB
Output Voltage Swing	V _{OM}	R _L ≥ 2kΩ	±12	±13.5		V
Input Common Mode Voltage Range	V _{ICM}		±12	±13.5		V
Common Mode Rejection Ratio	CMR	R _s ≤ 10 kΩ	80	110		dB
Supply Voltage Rejection Ratio	SVR	R _s ≤ 10 kΩ	80	110		dB
Operating Current	I _{CC}			6	9	mA
Slew Rate	SR	R _L ≥ 2kΩ		5		V/μs
Gain Bandwidth Product	GB	f=10kHz		15		MHz
Total Harmonic Distortion	THD	A _v =20dB, V _o = 5 V, f=1kHz, R _L =2kΩ		0.0005		%
Input Noise Voltage	V _{NI}	RIAA R _s =2.2kΩ, 30kHz LPF		0.8		μVrms

CHARACTERISTICS CURVES

Maximum Output Voltage Swing vs. Load Resistance

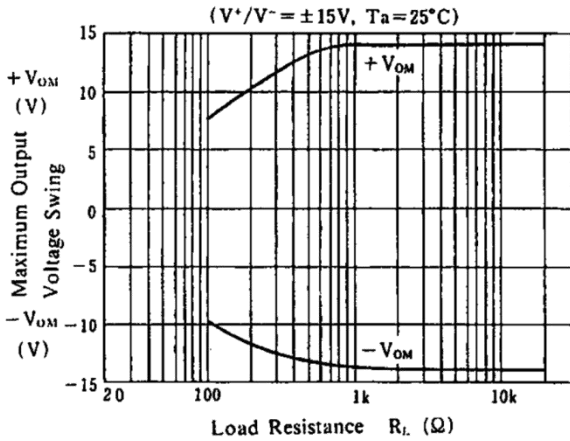

Maximum Output Voltage Swing vs. Frequency

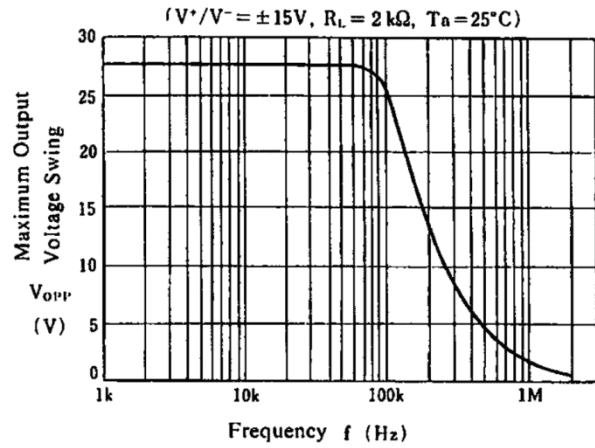

Output Voltage Swing vs. Output Current

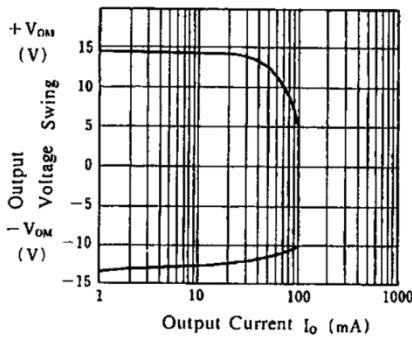

Equivalent Input Noise Voltage vs. Frequency

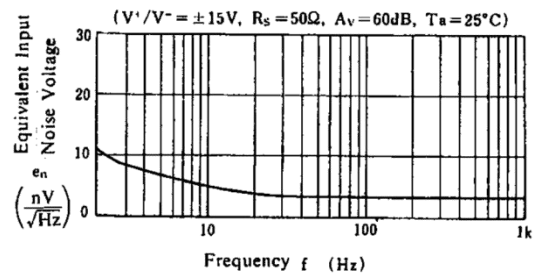

Operating Current vs. Temperature

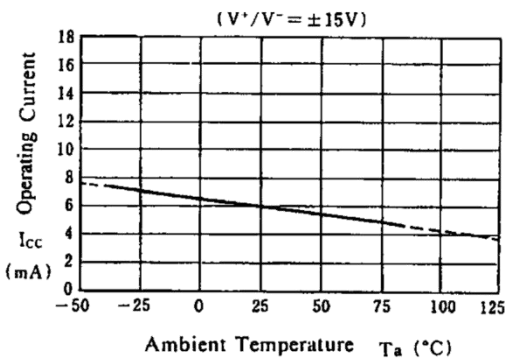

Output Voltage Swing vs. Temperature

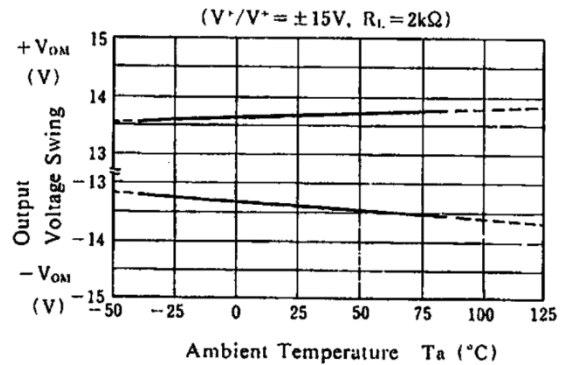

TYPICAL CHARACTERISTICS

Input offset Voltage vs. Temperature

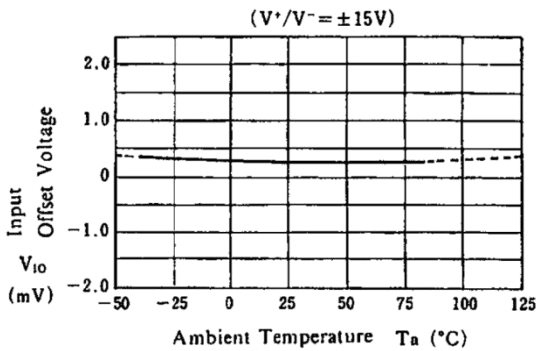

Input bias current vs. Temperature

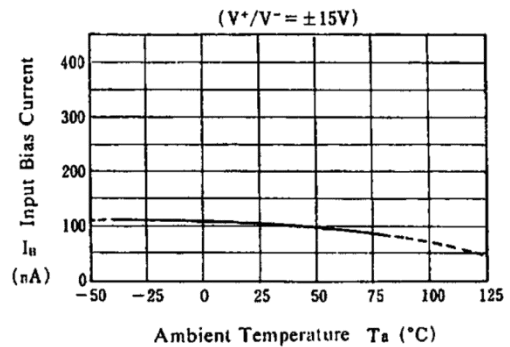

Maximum Output Voltage Swing vs. Operating Voltage

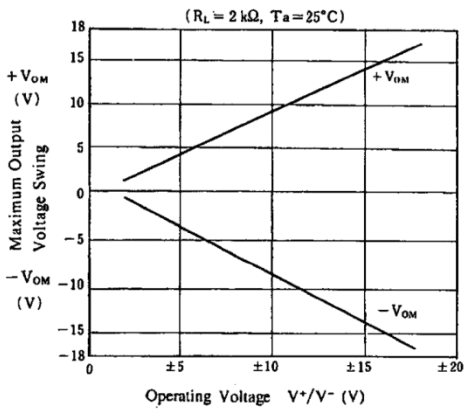

Operating Current vs. Operating Voltage

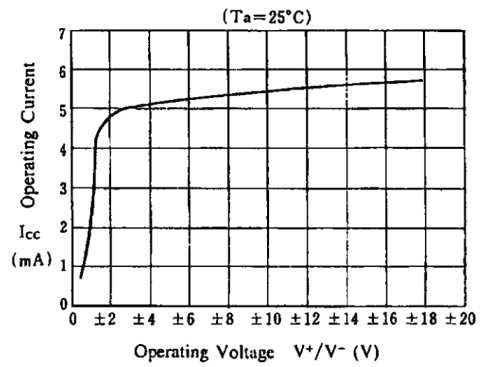

Total Harmonic Distortion vs. Output Voltage

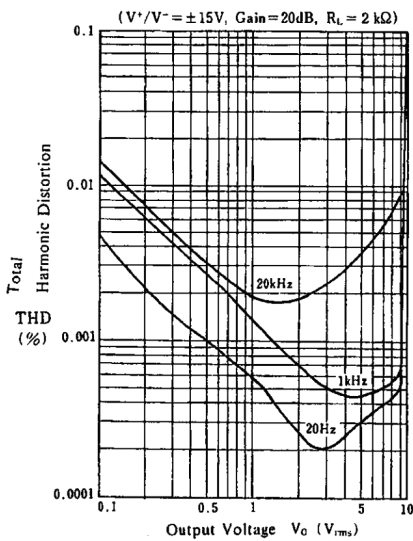

Voltage Gain Phase vs. Frequency

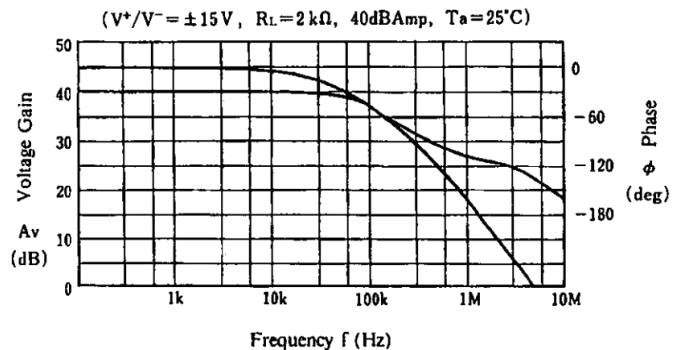

Physical Dimensions

DIP-8

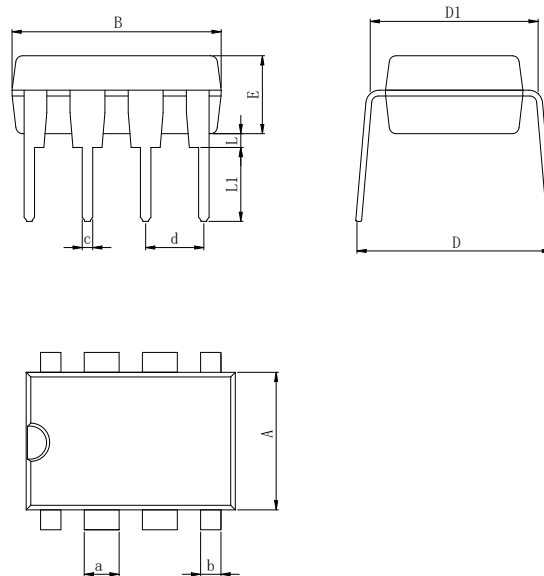
Dimensions In Millimeters(DIP-8)

Symbol:	A	B	D	D1	E	L	L1	a	b	c	d
Min:	6.10	9.00	8.10	7.42	3.10	0.50	3.00	1.50	0.85	0.40	2.54 BSC
Max:	6.68	9.50	10.9	7.82	3.55	0.70	3.60	1.55	0.90	0.50	

SOP-8 (150mil)

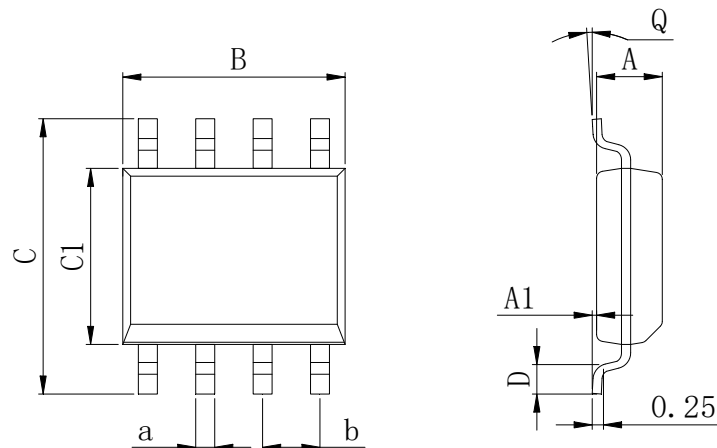
Dimensions In Millimeters(SOP-8)

Symbol:	A	A1	B	C	C1	D	Q	a	b
Min:	1.35	0.05	4.90	5.80	3.80	0.40	0°	0.35	1.27 BSC
Max:	1.55	0.20	5.10	6.20	4.00	0.80	8°	0.45	

Physical Dimensions

MSOP-8

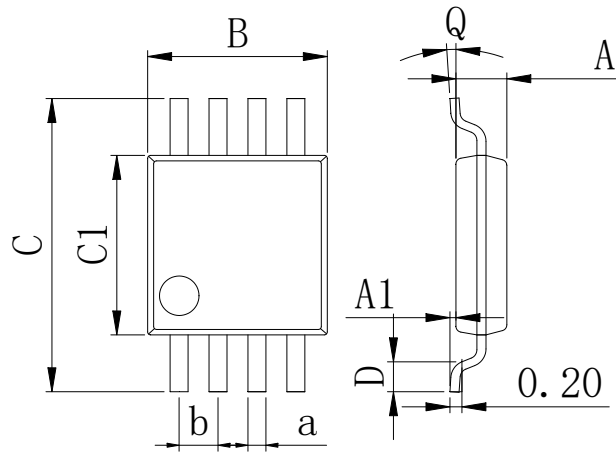

Dimensions In Millimeters(MSOP-8)									
Symbol:	A	A1	B	C	C1	D	Q	a	b
Min:	0.80	0.05	2.90	4.75	2.90	0.35	0°	0.25	0.65 BSC
Max:	0.90	0.20	3.10	5.05	3.10	0.75	8°	0.35	

Revision History

DATE	REVISION	PAGE
2014-6-9	New	1-9
2023-9-14	Update encapsulation type 、 Update Lead Temperature 、 Updated DIP-8 dimension、 Add annotation for Maximum Ratings.	1、 3、 6

IMPORTANT STATEMENT:

Huaguan Semiconductor reserves the right to change its products and services without notice. Before ordering, the customer shall obtain the latest relevant information and verify whether the information is up to date and complete. Huaguan Semiconductor does not assume any responsibility or obligation for the altered documents.

Customers are responsible for complying with safety standards and taking safety measures when using Huaguan Semiconductor products for system design and machine manufacturing. You will bear all the following responsibilities: Select the appropriate Huaguan Semiconductor products for your application; Design, validate and test your application; Ensure that your application meets the appropriate standards and any other safety, security or other requirements. To avoid the occurrence of potential risks that may lead to personal injury or property loss.

Huaguan Semiconductor products have not been approved for applications in life support, military, aerospace and other fields, and Huaguan Semiconductor will not bear the consequences caused by the application of products in these fields. All problems, responsibilities and losses arising from the user's use beyond the applicable area of the product shall be borne by the user and have nothing to do with Huaguan Semiconductor, and the user shall not claim any compensation liability against Huaguan Semiconductor by the terms of this Agreement.

The technical and reliability data (including data sheets), design resources (including reference designs), application or other design suggestions, network tools, safety information and other resources provided for the performance of semiconductor products produced by Huaguan Semiconductor are not guaranteed to be free from defects and no warranty, express or implied, is made. The use of testing and other quality control technologies is limited to the quality assurance scope of Huaguan Semiconductor. Not all parameters of each device need to be tested.

The documentation of Huaguan Semiconductor authorizes you to use these resources only for developing the application of the product described in this document. You have no right to use any other Huaguan Semiconductor intellectual property rights or any third party intellectual property rights. It is strictly forbidden to make other copies or displays of these resources. You should fully compensate Huaguan Semiconductor and its agents for any claims, damages, costs, losses and debts caused by the use of these resources. Huaguan Semiconductor accepts no liability for any loss or damage caused by infringement.