

# SPECIFICATIONS

Current Rating: 3Amps  
 Insulation Resistance: 1000MΩ Min  
 Contact Resistance: 20mΩ Max  
 Withstanding Voltage: AC 1000V  
 Operation Temperature: -40° to +105°  
 Contact Material: Brass  
 Standard: 6T  
 Insulator Material: Polyester  
 Contact Plating: Gold Flash  
 Max. Processing Temp: 200° C for 30-60 seconds  
 (260° C for 5 seconds)

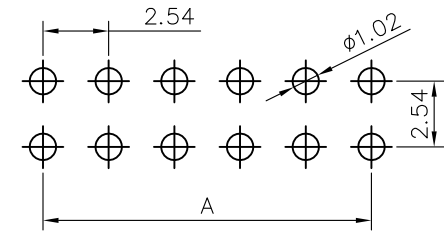
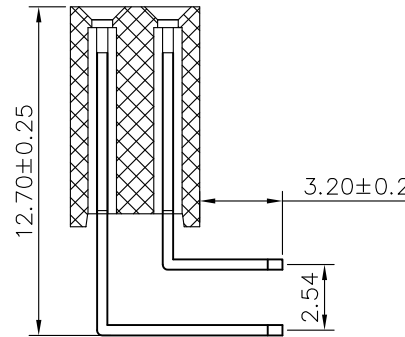
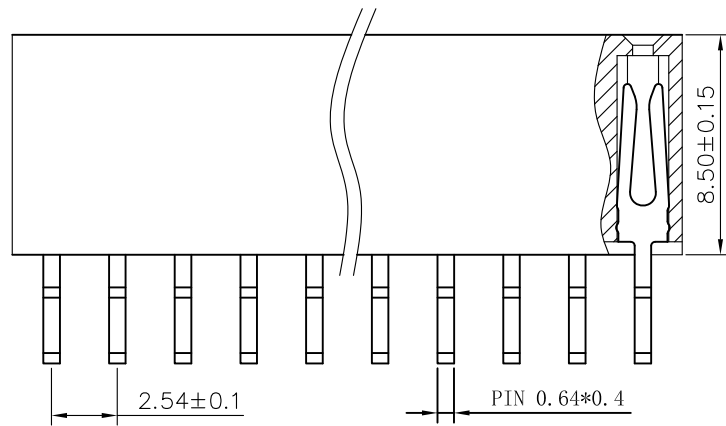
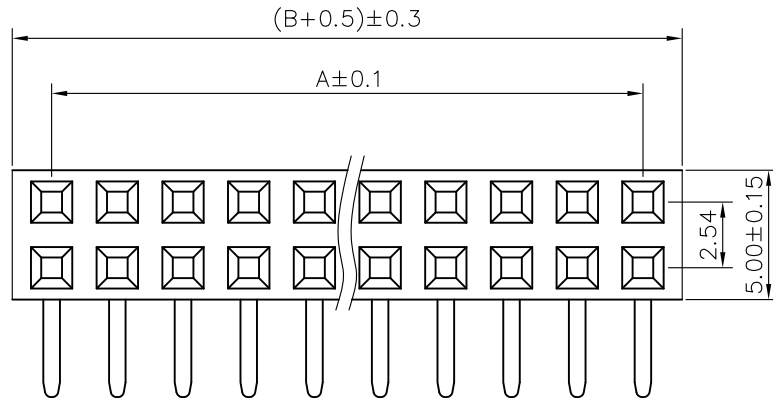

RECOMMEND P. C. B LAYOUT  
 PCB TOLERANCE: ±0.05 (TOP VIEW)

# 深圳市虹成电子有限公司

No. of	DIM. A	DIM. B	No. of	DIM. A	DIM. B	No. of	DIM. A	DIM. B	No. of	DIM. A	DIM. B
1	0.00	2.54	11	25.40	27.94	21	50.80	53.34	31	76.20	78.74
2	2.54	5.08	12	27.94	30.48	22	53.34	55.88	32	78.74	81.28
3	5.08	7.62	13	30.48	33.02	23	55.88	58.42	33	81.28	83.82
4	7.62	10.16	14	33.02	35.56	24	58.42	60.96	34	83.82	86.36
5	10.16	12.70	15	35.56	38.10	25	60.96	63.50	35	86.36	88.90
6	12.70	15.24	16	38.10	40.64	26	63.50	66.04	36	88.90	91.44
7	15.24	17.78	17	40.64	43.18	27	66.04	68.58	37	91.44	93.98
8	17.78	20.32	18	43.18	45.72	28	68.58	71.12	38	93.98	96.52
9	20.32	22.86	19	45.72	48.26	29	71.12	73.66	39	96.52	99.06
10	22.86	25.40	20	48.26	50.80	30	73.66	76.20	40	99.06	101.60

UNLESS OTHERWISE SPECIFIED TOLERANCE

X : ±0.30 X° : ±5°  
 X.X : ±0.25 X.X° : ±1°  
 X.XX : ±0.20 X.XX° : ±0.5°

DRAWN NAME: 2.54FH H8.5 2xnPin 90度 Y型 PC3.2 PB12.7 PBT

SIZE	A4	SCALE	N:1	PROUCT NO.	HC-PM254-8.5H-2x16PW
REV	A	UNIT	mm	PROJECT	PAGE 1/1

CHECKED: 陈超凡 2022/05/12 CHECKED: / / APPROVED: / /